

avenlur

Betula by Avenlur



Need Help?

CALL US AT 888.697.3931 / M-F 9AM - 5PM PT (12PM - 8PM ET)
OR EMAIL US AT INFO@AVENLUR.COM

V2

WARNING

Adult assembly required.

WARNING

Maximum user weight: 220 lbs (100kg) per child.

WARNING

CHOKING HAZARD:

Adult assembly required. Keep small assembly parts out of reach of children.

 Use under adult supervision.

OBSERVE ALL STATEMENTS AND WARNINGS TO REDUCE THE LIKELIHOOD OF SERIOUS OR FATAL INJURY. SAVE THIS SHEET FOR FUTURE REFERENCE.

OPERATION INSTRUCTIONS

1. An adult should always supervise use of this product by children of all ages.
2. Maximum weight per user: 220 lbs (100kg)
3. Instruct children not to attach items to the playground equipment that are not specifically designed for use with the equipment (examples: ropes, clothesline, pet leashes, cables and chain, etc) as they may cause a strangulation hazard or any other hazard.
4. Never allow children to use the equipment in a manner other than intended.

MAINTENANCE INSTRUCTIONS

1. Inspect the product periodically for loose or damaged components. **Tighten bolts if need.**
2. Check all connections and bolts for tightness at least twice monthly during the usage.
3. Check all coverings and bolts for sharp edges.

INSTALLATION INSTRUCTIONS

Please have an electrical drill available for assembly if possible.

If you have difficulty in installation, please contact us for help and get installation video for reference.

Please Ensure:

1. You are assembling with at least two people to ensure that all sides and parts are leveled.
2. You don't screw the parts in too hard or it will splinter the wood.
3. You follow the directions carefully.

CONTACT US BEFORE ASSEMBLY

If you have assembly questions or if you need parts
whether they are missing or damaged

Call us at 888-697-3931 or email us at

info@Avenlur.com

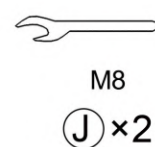
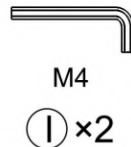
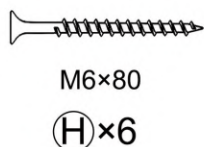
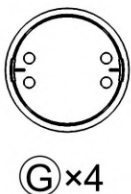
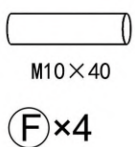
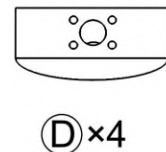
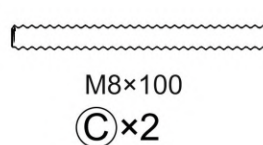
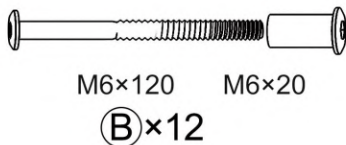
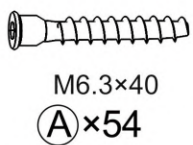
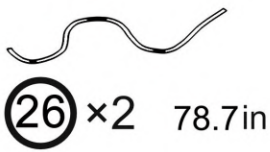
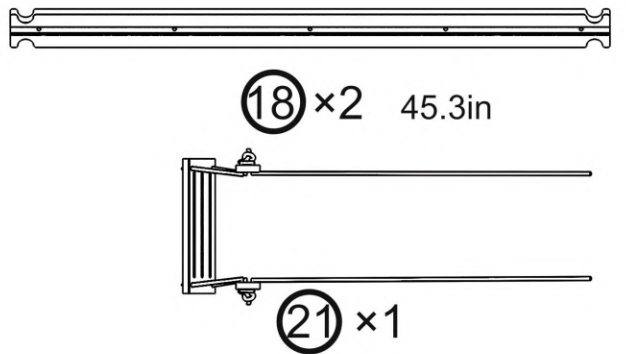
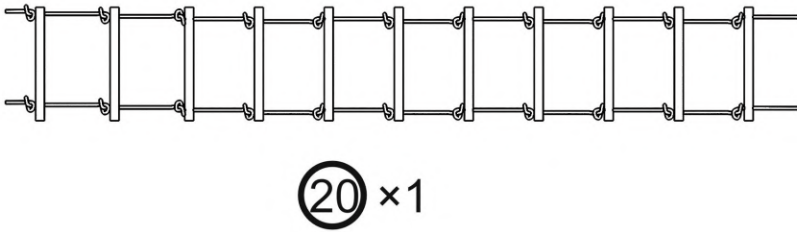
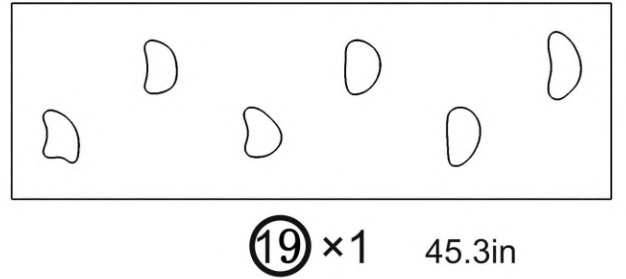
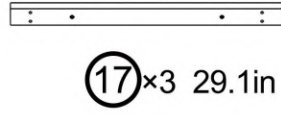
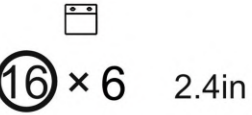
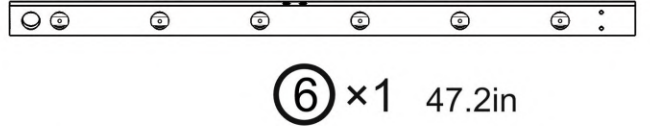
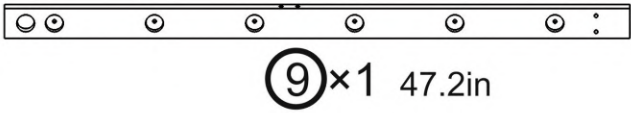
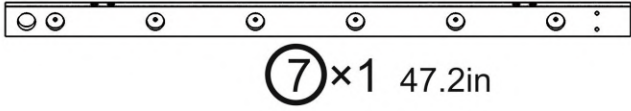
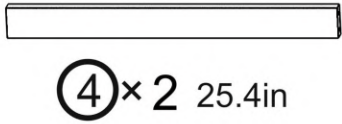
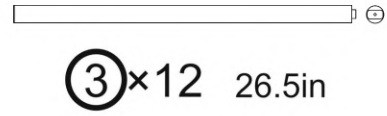
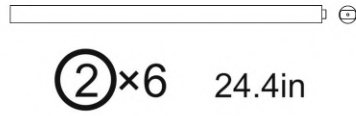
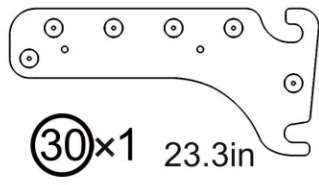
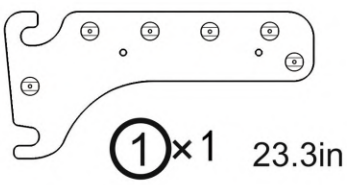

Self-provided tools



Pen



Drill

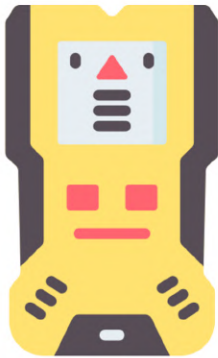

Studfinder



Measuring tape



Level

A1-1

Note: Pay attention to the black bubbled section markers on the left. The manual will refer back to those later

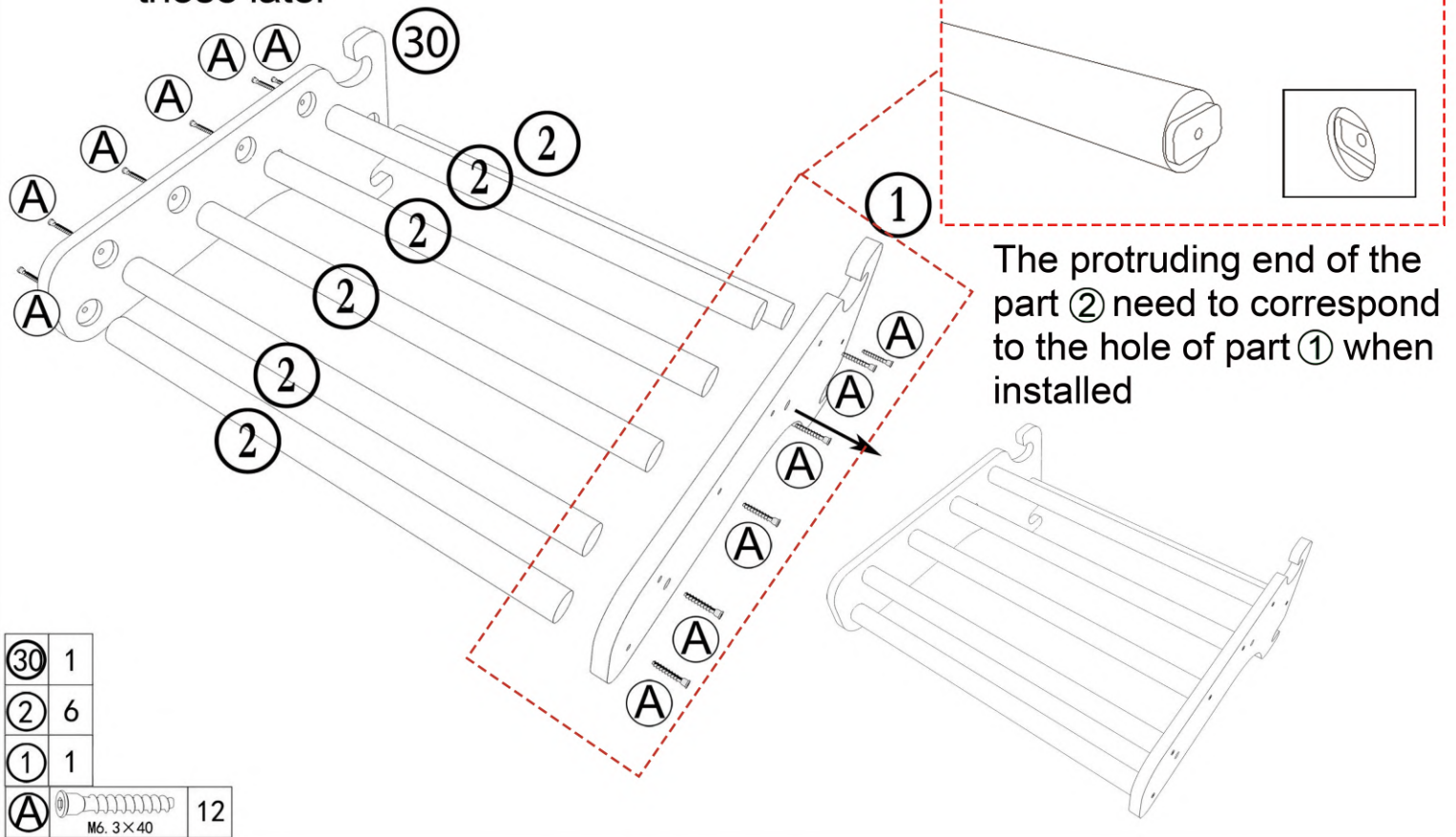

The protruding end of the part ② need to correspond to the hole of part ① when installed

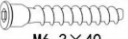
③①	1	
②	6	
①	1	
Ⓐ	 M6, 3×40	12

B1-1

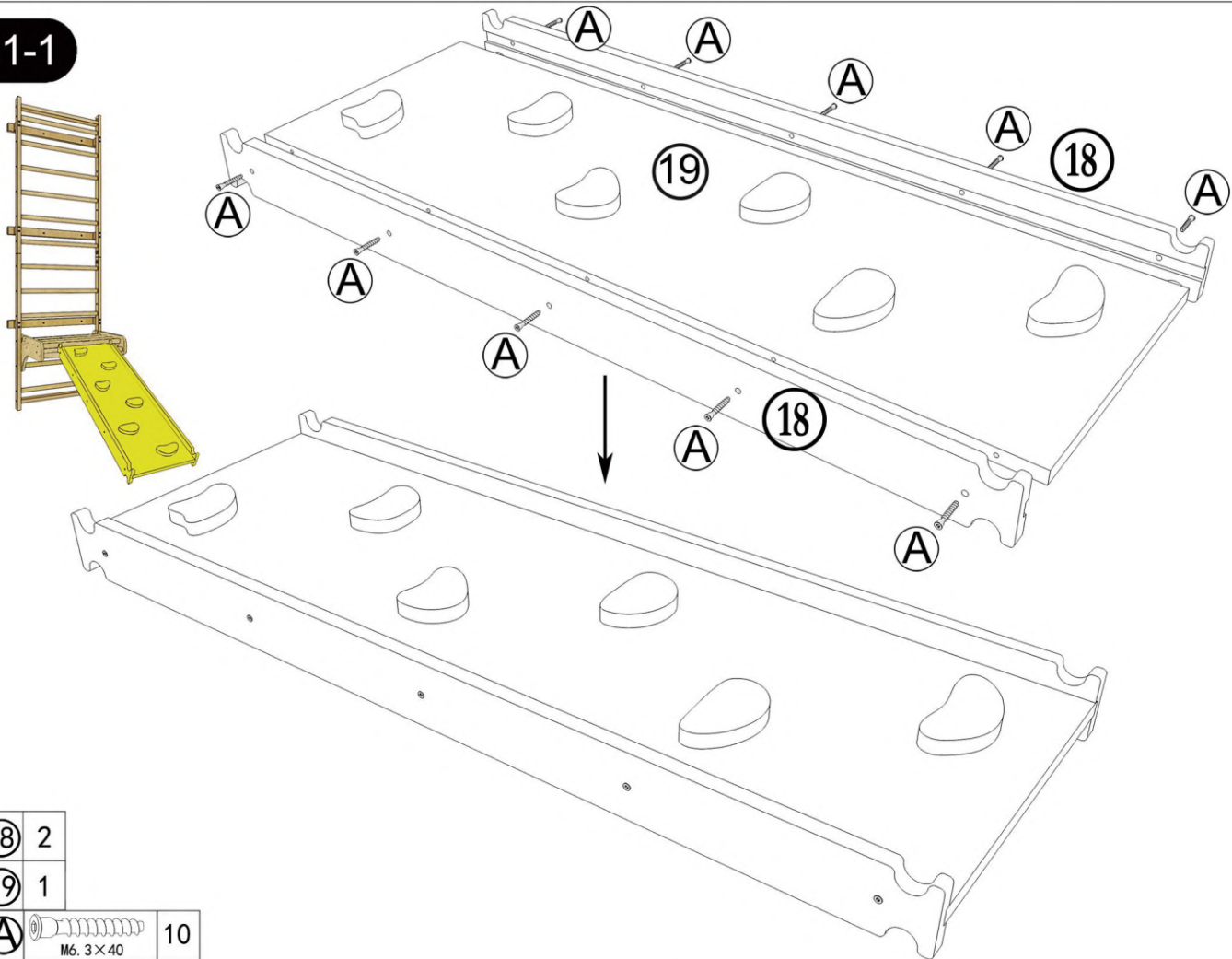

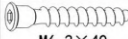
⑱	2	
⑲	1	
Ⓐ	 M6, 3×40	10

C1-1

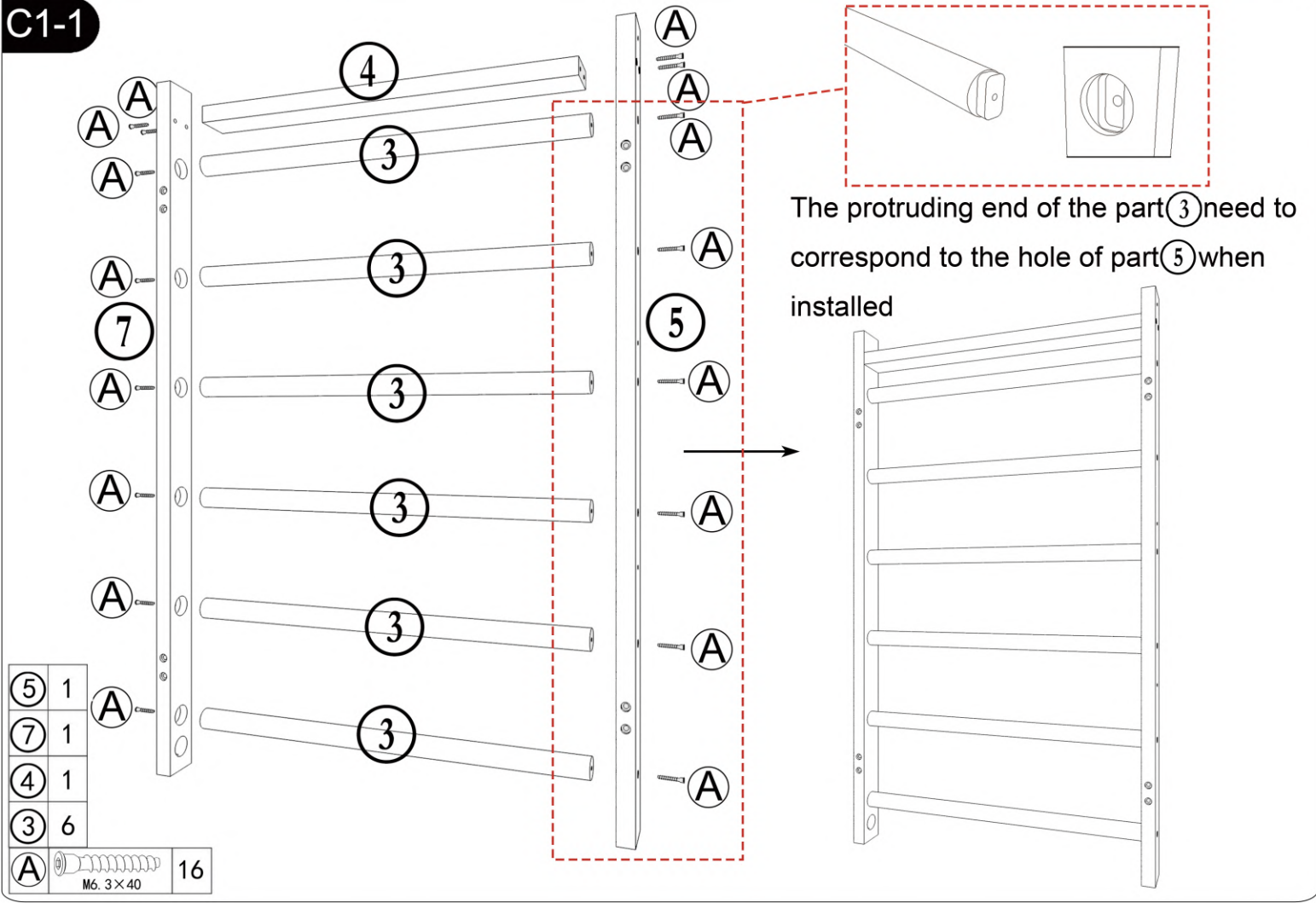

C2-1

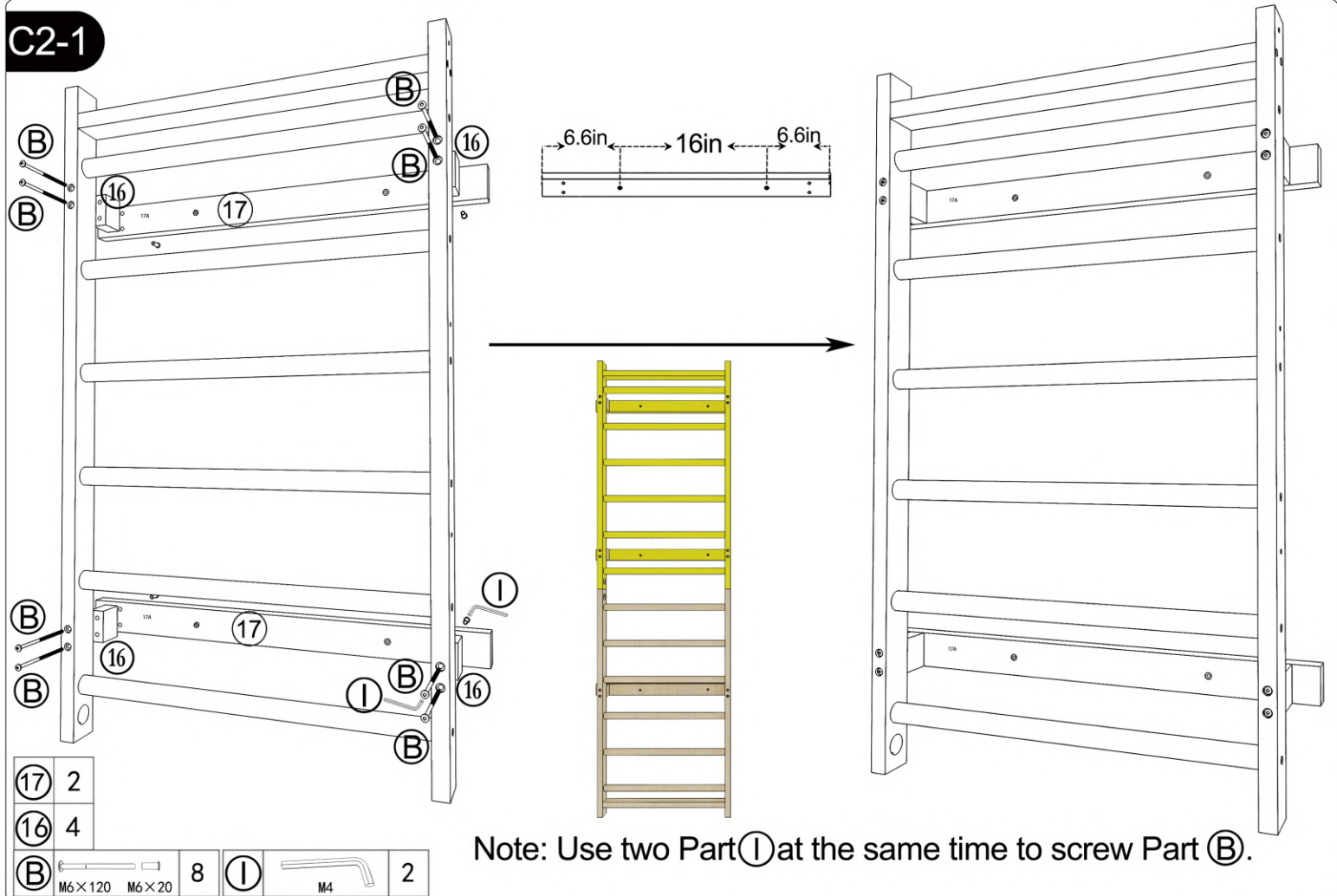

D1-1

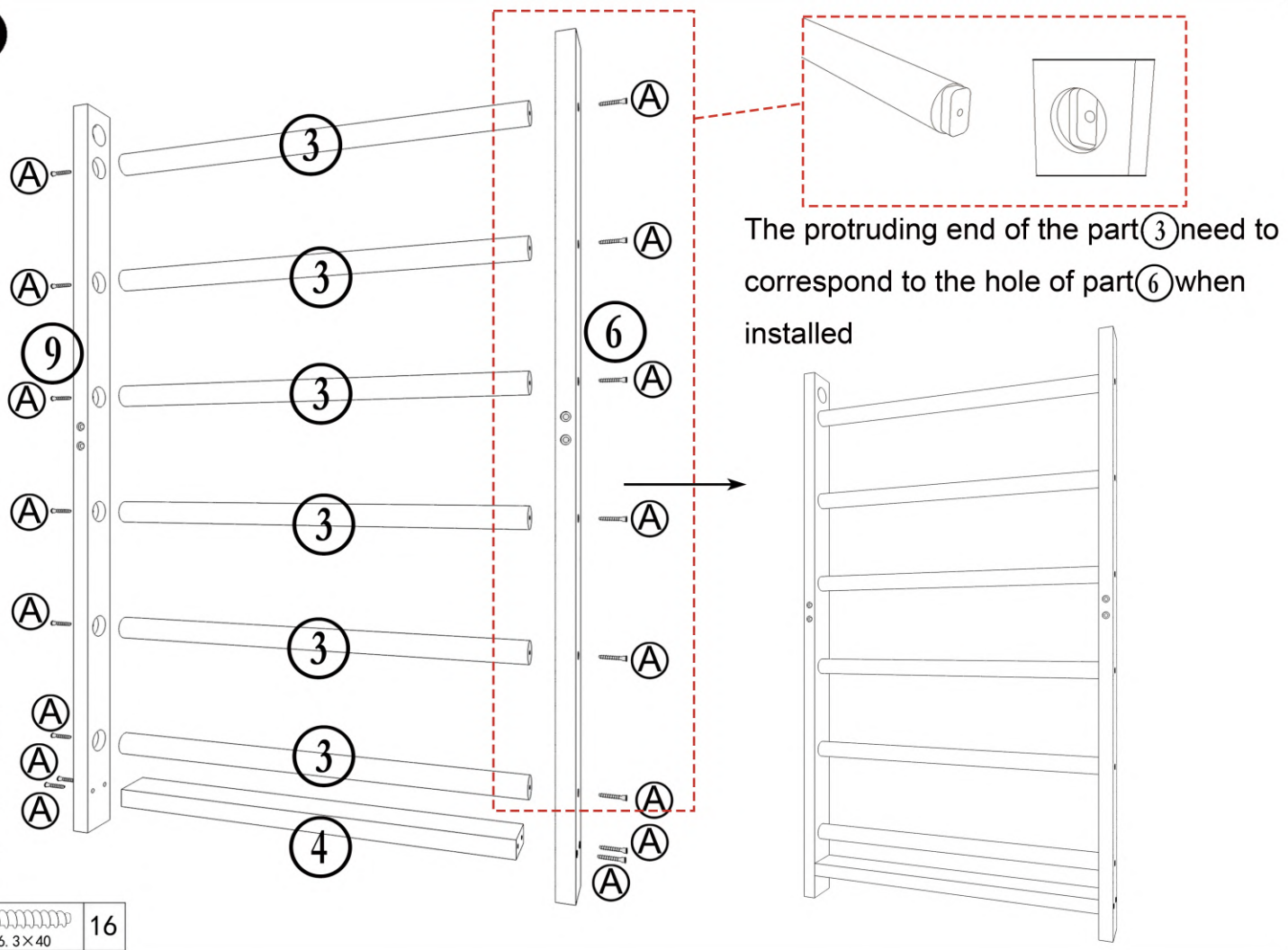

D2-1



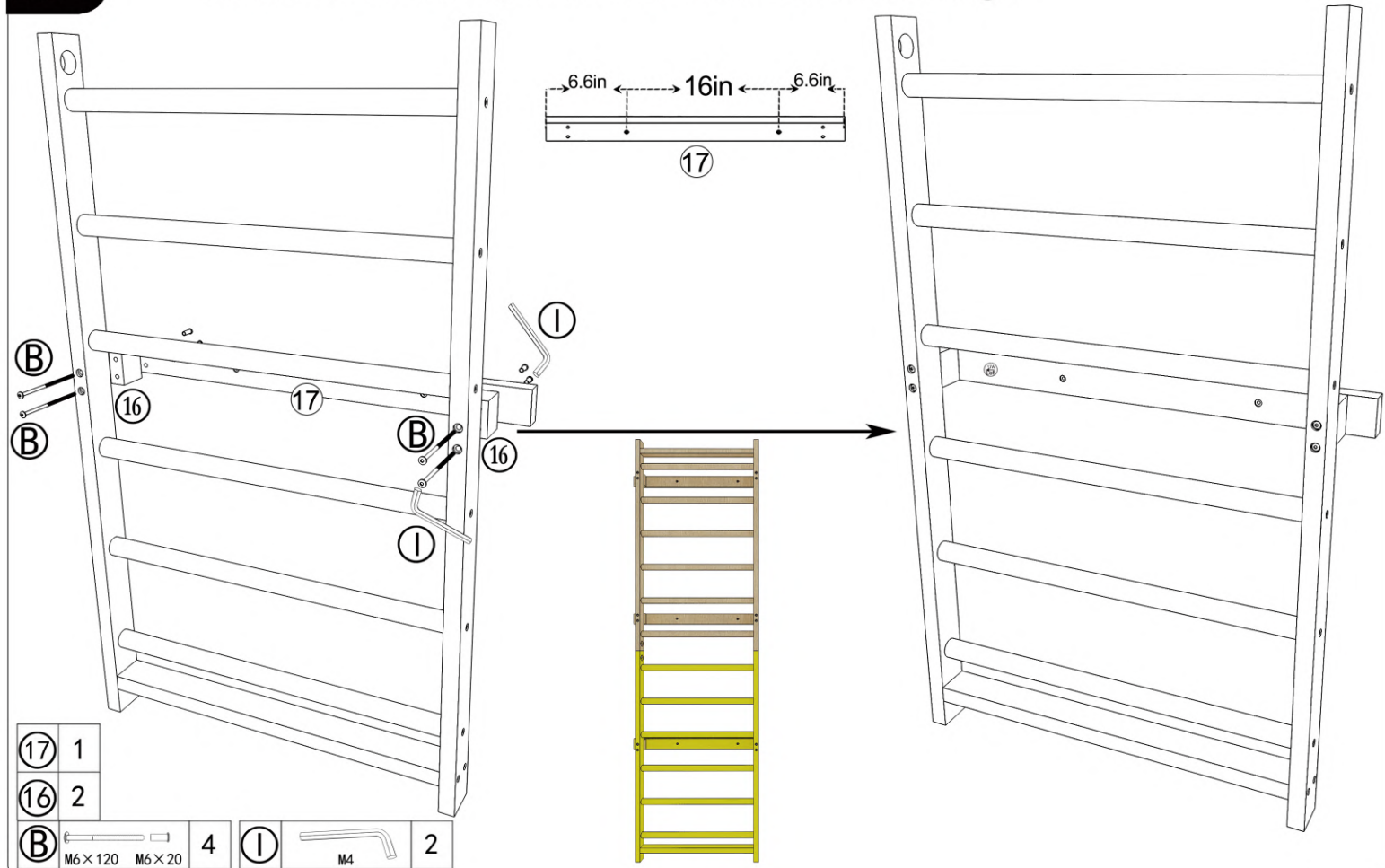

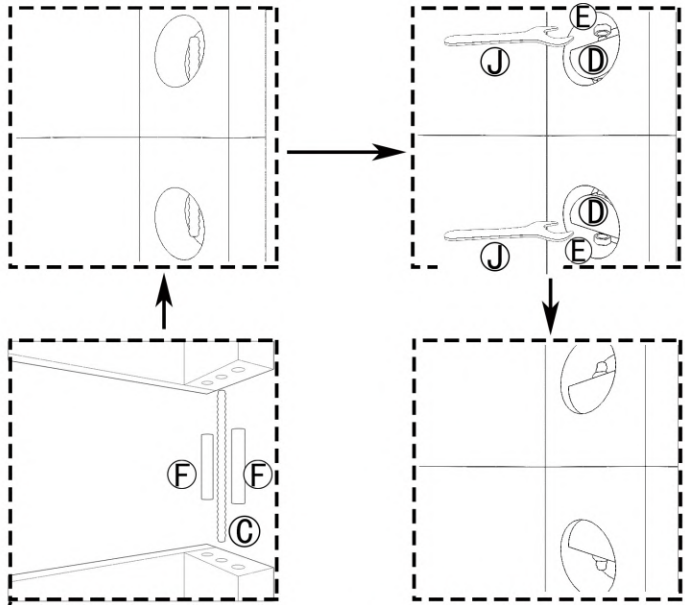
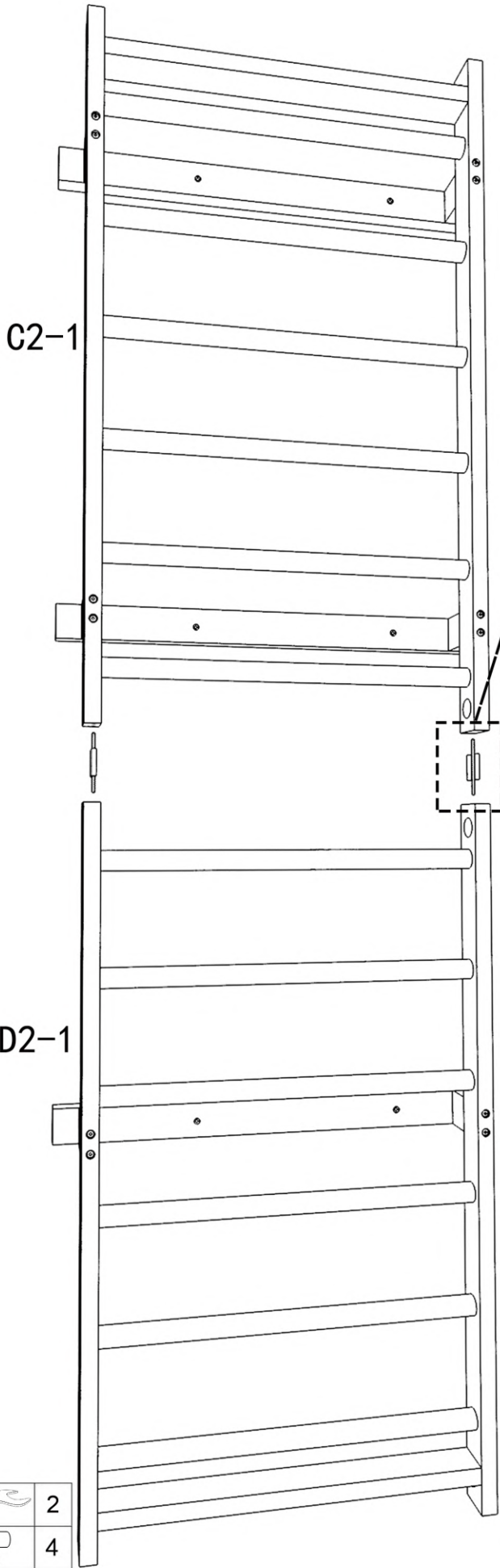
Note: Use two Part (I) at the same time to screw Part (B).



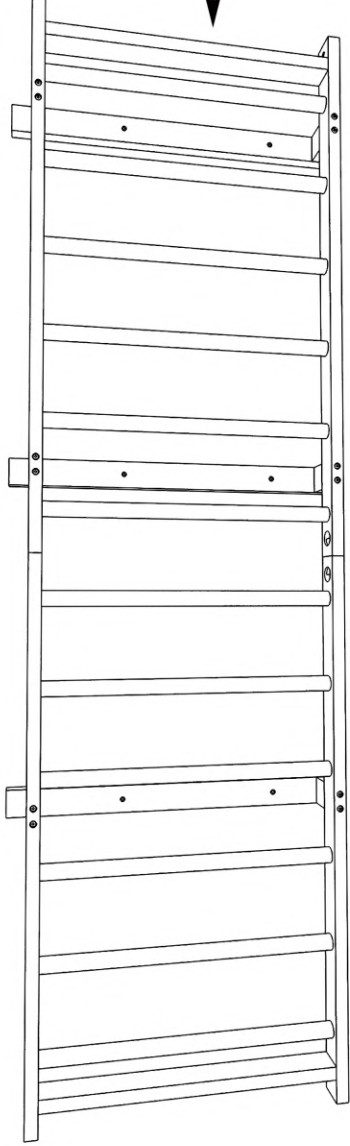

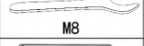
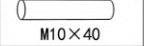
Note: Insert parts C and F into the holes. Then attach part D through C. Lastly, screw E onto C



J	 M8	2
F	 M10 x 40	4
E	 M8	4
D		4
C	 M8 x 100	2

Attaching to Wall Studs

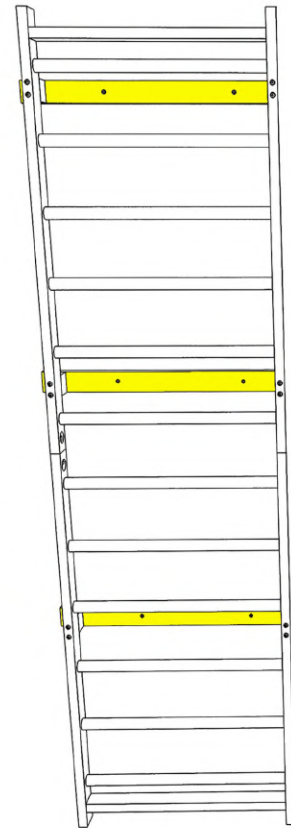
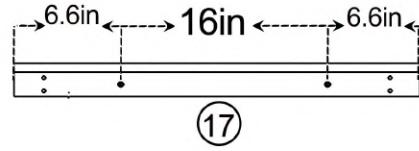
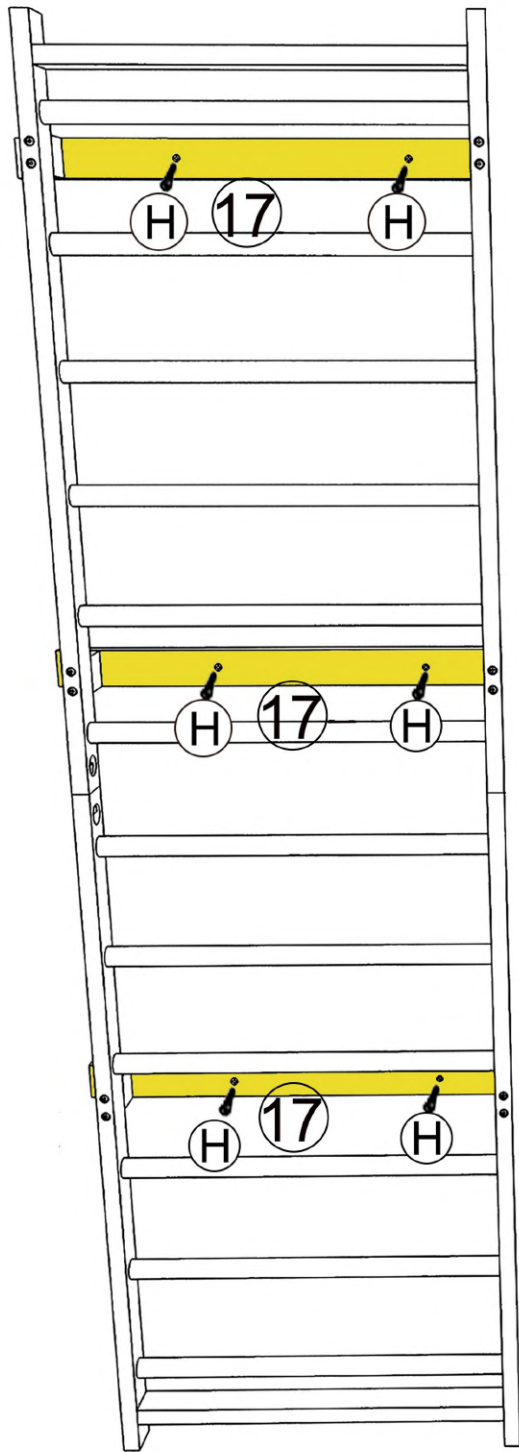

Use a studfinder and mark the wall where the center of the studs are. Studs are typically 16" apart. Measure the distance between your studs to confirm.

Mark, level, and predrill holes in the wall to attach parts 17 with screws H.

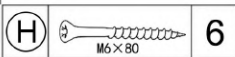

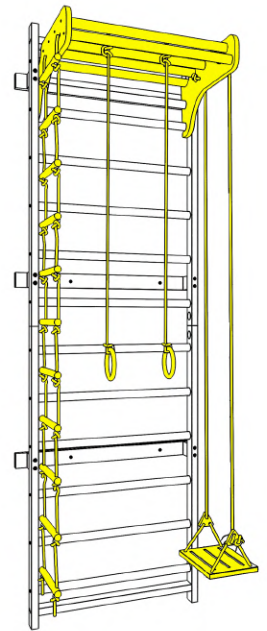

25.7in

A1-1

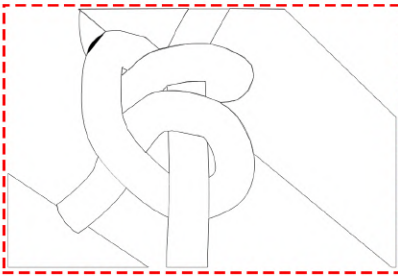
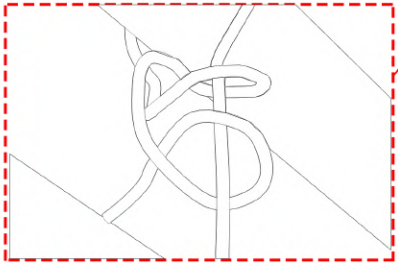
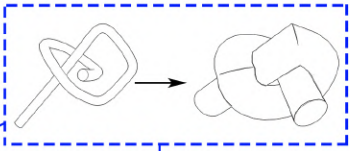

26

26

22

22

20

21

8in

29.1in

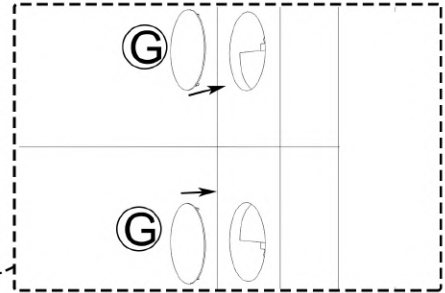

94.5in

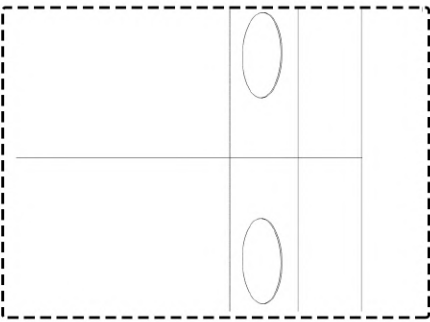

26	2
22	2
21	1
20	1
H	4

