

avenlur

Forrest by Avenlur



Need Help?

CALL US AT 888.697.3931 / M-F 9AM - 5PM PT (12PM - 8PM ET)
OR EMAIL US AT INFO@AVENLUR.COM



**FOR ADDITIONAL ASSISTANCE
PLEASE CALL US AT 888-697-3931
M-F 9AM-5PM PT (12PM-8PM ET)
OR EMAIL US AT**

info@avenlur.com

CONTACT US BEFORE ASSEMBLY

If you have assembly questions or if you need parts
whether they are missing or damaged

Call us at 888-697-3931 or email us at
info@Avenlur.com

- ◆ READ THE ASSEMBLY MANUAL COMPLETELY, PAYING SPECIAL ATTENTION TO THE IMPORTANT TIPS AND SAFETY INFORMATION. WE ADVISE OUR CUSTOMERS TO HIRE PROFESSIONAL HELP FOR INSTALLING THIS PLAYSET.
- ◆ SEPARATE AND IDENTIFY ALL PARTS TO MAKE SURE THAT YOU HAVE ALL OF THE PARTS LISTED. IF YOU CAN'T FIND ALL OF THE PARTS, CHECK THE PACKING MATERIAL. SMALL PARTS MAY HAVE FALLEN OUT OF THE PACKET AND INTO THE MAIN BOX DURING TRANSIT.
- ◆ PLEASE HAVE AN ELECTRIC DRILL AVAILABLE FOR ASSEMBLY.
- ◆ PLEASE NOTE: THE WOOD IS TREATED WITH ANTI CORROSIVE TREATMENT WHICH MAY RESULT IN VERY SMALL CRACKS OR ROUGH SURFACES IN AREAS. THIS IS VERY NORMAL AND STANDARD. THIS WILL NOT AFFECT THE SAFETY AND STABILITY OF THE WOOD AND THE SWINGSET.
- ◆ WE HAVE USED A WHITE PAINT DESIGNED FOR OUTDOOR USE. HOWEVER AS WITH ALL WHITE PAINT THAT IS SUBJECT TO THE ELEMENTS. IT MAY BEGIN TO FADE AFTER A FEW YEARS. AT WHICH POINT YOU MAY PURCHASE PAINT FROM A LOCAL HARDWARE STORE AND RECOAT

PLEASE READ THIS BEFORE STARTING ASSEMBLY

PLEASE HAVE THE FOLLOWING INFORMATION WHEN YOU MAKE YOUR CALL:

- 1 – MODEL NUMBER OF THE PRODUCT LOCATED ON THE FRONT OF THE ASSEMBLY MANUAL
- 2 – DESCRIPTION OF THE PART FROM THE PARTS LIST

POR FAVOR TENGA VISIBLE LA SIGUIENTE INFORMACIÓN CUANDO LLAME:

- 1 - NÚMERO DE MODELO DEL PRODUCTO QUE SE ENCUENTRA UBICADO AL FRENTE DEL MANUAL DE ENSAMBLAJE
- 2 - DESCRIPCIÓN DE LA PIEZA QUE SE ENCUENTRA EN LA LISTA DE PIEZAS

Please read entire booklet completely before beginning the assembly process.

Equipment is recommended for use by children 3-12 years of age. Structures are not intended for public use. Avenlur does not warranty any of its residential structures subjected to commercial use such as: Daycare, Preschool, Nursery School, Recreational Park, or any similar Commercial Application.



WARNING:

This Symbol points out important safety instructions which, if not followed could endanger the personal safety of yourself and your children and/or damage your property. You **MUST** read and follow all instructions in this manual before attempting to use this playcenter.



WARNING:

Children must **NOT** use this playcenter until unit has been completely assembled and inspected by an adult to insure set has been properly installed and anchored.

Please follow all recommendations below. **Failure to do so may result in the warranty being void and/or safety violations that could result in serious injury.** This manual contains helpful information concerning Assembly Preparation, Installation Procedure, and Required Maintenance. Always keep the safety of your children in mind as your play structure is being built and as your children play on the set. Before your children play on the set please review the Operation Instructions with them to help ensure their safety.

PLEASE RETAIN THESE INSTRUCTIONS FOR FUTURE REFERENCE. KEEP THEM IN A SAFE PLACE ,WHERE YOU CAN REFER TO THEM AS NEEDED. IN ORDER TO PROVIDE YOU WITH THE MOST EFFICIENT SERVICE, IT IS REQUIRED THAT YOU PROVIDE US WITH THE PART NUMBERS WHEN ORDERING PARTS.

Positioning Your Playcenter

1. The Playcenter is designed to be installed on a level surface by an Adult with an Adult helper. Place in a flat area of your yard to minimize ground preparation.
2. Choose a leveled location for the equipment. This can reduce the likelihood of the play set tipping over and loose-fill surfacing material washing away during heavy rains.
3. Place the equipment not less than 6 ft (1.8 m) from any structure or obstruction such as a fence, garage, house, overhanging branches, laundry lines, or electrical wires.
4. Provide enough room so that the children can use the equipment safely. For example, for structures with multiple play activities, a slide should not exit in front of a swing.
5. It is a good idea to place your Playcenter in an area that is convenient for adults to watch children at play.
6. Create a site free of obstacles that could cause injuries – such as low overhanging tree branches, overhead wires, tree stumps and/or roots, large rocks, bricks and concrete. Additional suggestions in the Suggested Playground Surfacing Section.
7. Locate bare metal platforms and slides out of direct sunlight to reduce the likelihood of serious burns. A slide that faces north will receive the least direct sunlight.

Suggested Playground Surfacing

1. Do not install home playground equipment over concrete, asphalt, packed earth, grass, carpet, or any other hard surface. A fall onto a hard surface can result in serious injury to the equipment user.
2. Do not install loose fill surfacing over hard surfaces such as concrete or asphalt. Shredded bark mulch, wood chips, fine sand and fine gravel, are added as shock absorbing materials after assembly. If used properly these materials can absorb some of the impact of a child's fall.
3. All surface material should extend a minimum of 6 feet in all directions around the play area.
4. Do not apply playground surfacing until after the unit is completely constructed. Playset should not be built on top of surfacing.
5. Use containment, such as digging out around the perimeter and/or lining the perimeter with landscape edging.
6. Installations of rubber tiles or poured-in-place surfaces (other than loose-fill materials) generally require a professional and are not “do-it-yourself” projects.
7. Use Playground Surfacing Materials (other than loose-fill material) which comply with the safety standard ASTM F1292 Standard Specification of Impact Attenuation of Surfacing Materials within the Use Zone of Playground Equipment.

Operating Instructions:



NOTE:

Your children's safety is our #1 concern.

Observing the following statements and warnings reduces the likelihood of serious or fatal injury. Please review these safety rules regularly with your children.

1. This Playcenter is designed for specific number of occupants whose combined weight should not exceed a designated weight on the elevated floor or the swing area, the total Unit capacity is outlined in the Basic Setup Dimensions section of instruction manual. The maximum fall height and recommended play area is also available in the Basic Setup Dimensions section of the manual for the specific unit.
2. On-site adult supervision is required.
3. Instruct children not to walk close to, in front of, behind, or between moving swings or other moving playground equipment.
4. Instruct children to sit in and never stand on swings
5. Instruct children not to twist the chains and ropes and not to loop them over the top support bar, since this may reduce the strength of the chain or rope.
6. Instruct children not to jump from swings or other playground equipment in motion.
7. Instruct children to not to push empty seats. The seat may hit them and cause serious injury.
8. Instruct and teach children to sit in the center of the swings with their full weight on the seats.
9. Instruct children not to use the equipment in a manner other than intended.
10. Instruct children to always go down slides feet first. Never slide head first.
11. Instruct children to look before they slide to make sure no one is at the bottom.
12. Instruct children to never run up a slide, as this increases their chances of falling.
13. The parents should dress children appropriately. (Examples would include the use of well-fitting shoes and the avoidance of ponchos, scarfs, and other loose-fitting clothing that is potentially hazardous while using equipment).
14. Instruct children not to climb when the equipment is wet.
15. Instruct children to never jump from a deck. They should always use the ladder, ramp or slide.
16. Instruct children to never crawl on top of the roof.
17. Verify that any suspended climbing ropes, chain, or cable are secured at both ends and that they cannot be looped back on it.
18. Instruct children not to attach items to the playground equipment that are not specifically Designed for use with the equipment, such as, but not limited to, jump ropes, clothes line, pet leashes, cables and chain as they may cause a strangulation hazard.
19. Instruct children to never wrap their legs around swing chain. Instruct children to never slide down the swing chain. Instruct children to remove their bike or other sports helmet before playing on playground equipment.

Maintenance Instructions:

At the beginning of each play season:

- Tighten all hardware.
- Lubricate all metallic moving parts per manufacturer's instructions.
- Check all protective coverings on bolts, pipes, edges, and corners. Replace if they are loose, cracked, or missing.
- Check all moving parts including swing seats, ropes, cables, and chains for wear, rust, or other deterioration. Replace as needed.
- Check metal parts for rust. If found, sand and repaint using a non Lead-based paint meeting the requirements of 16 CFR 1303 .
- Check all wood members for deterioration and splinters. Sand down splinters and replace deteriorating wood members.
- Reinstall any plastic parts, such as swing seats or any other items that were removed for the cold season.
- Rake and check depth of loose fill protective surfacing materials to prevent compaction and to maintain appropriate depth. Replace as necessary.

Twice a month during play season:

- Tighten all hardware.
- Check all protective coverings on bolts, pipes, edges, & corners. Replace if they are loose, cracked, or missing.
- Rake and check depth of loose fill protective surfacing materials to prevent compaction and to maintain appropriate depth. Replace as necessary.

Once a month during play season:

- Lubricate all metallic moving parts per manufacturer's instructions.
- Check all moving parts including swing seats, ropes, cables, and chains for wear, rust, or other deterioration. Replace as needed.

At the end of each play season or when the temperature drops below 32° F:

- Remove plastic swing seats and other items as specified by the manufacturer and take indoors or do not use.
- Rake and check depth of loose fill protective surfacing materials to prevent compaction and to maintain appropriate depth. Replace as necessary.

Last but not least :

White paint by nature will fade when outdoors within 1-2 years due to exposure to sunlight and the elements. You may purchase outdoor white paint and apply a new coating every few years to keep the white color fresh.

Additional Maintenance:

- Check the swing beam and hardware every two weeks due to wood expansion and contraction. It is particularly important that this procedure be followed at the beginning of each season.
- Inspect wood parts monthly. The grain of the wood sometimes will lift in the dry season causing splinters to appear. Light sand may be necessary to maintain a safe playing environment. Treat your playset with stain regularly, to help prevent severe checking/splitting and other weather damage.
- A waterbourne transparent stain has been applied to your playset. This is done for color only. Once or twice a year, depending on your climate conditions, you must apply some type of protection (sealant) to the wood of your unit. Prior to the application of sealant, lightly sand any "rough" spots on your playset. Please note this is a requirement of your warranty.
- Assembling and maintaining the playset on a level location is very important. As your children play, your playset will slowly dig its way into the soil, and it is very important that it settles evenly. Make sure the playset is level and true one each year or at the beginning of each play season.

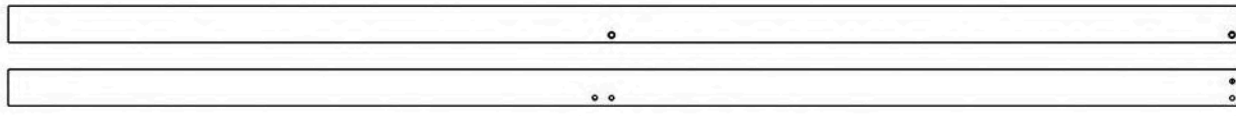

①x2 92.9in

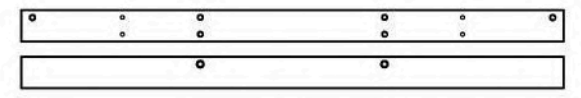

②x1 40.6in

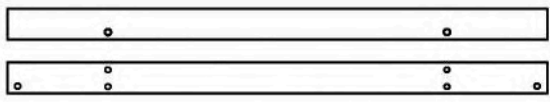

③x1 40.6in

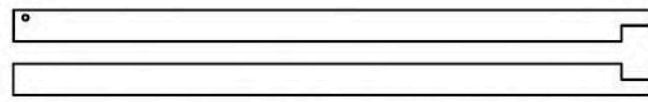

④x3 48 in

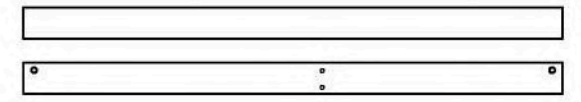

⑤x1 40.6in

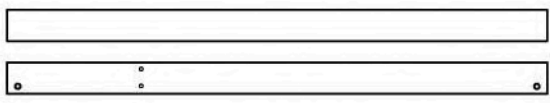

⑥x1 40.6 in

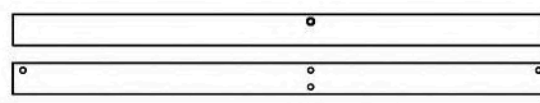

⑦x1 40.6in

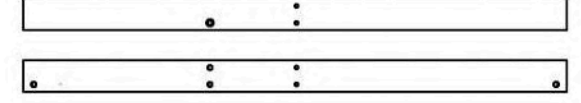

⑧x1 40.6 in



⑨x2 10.2in

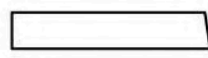

⑩x2 15in



⑪x2 66.9in

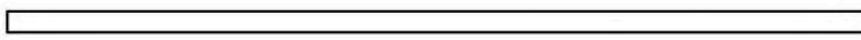

⑫x4 64.6in

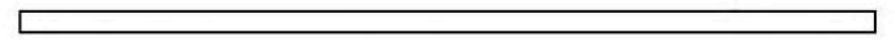

⑬x2 64.6 in

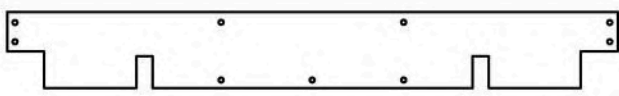

⑭x1 46.1in

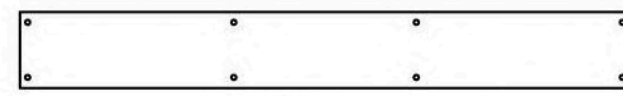

⑮x4 46.1in

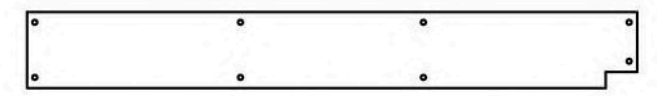

⑯x1 46.1in

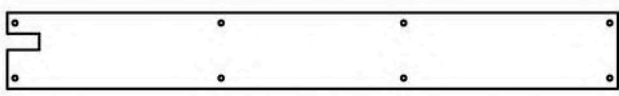

⑰x1 46.1in

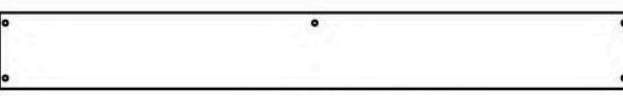

⑱x1 47.6in



⑲x6 47.6 in

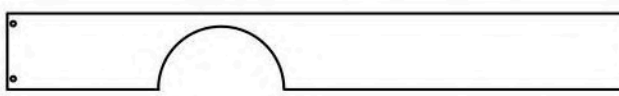

⑳x1 47.6in

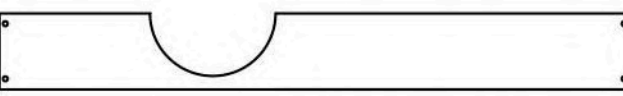

㉑x1 47.6 in

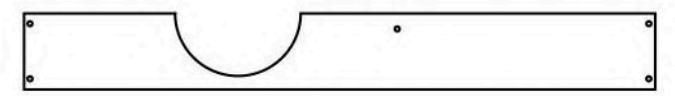

㉒x1 47.6 in

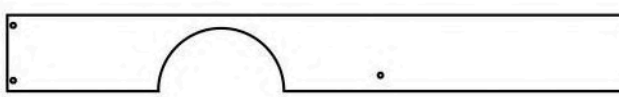

㉓x1 47.6in

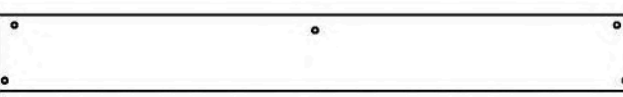

㉔x4 47.6in

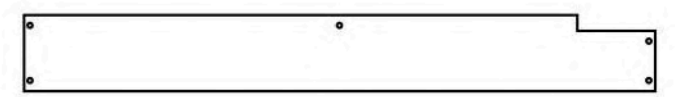

㉕x1 47.6in

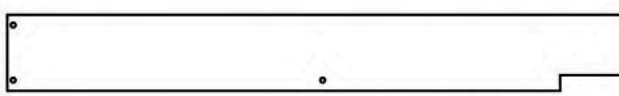

㉖x1 47.6in

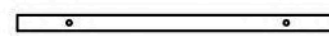

㉗x1 24.3 in

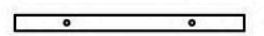

㉘x2 17.3 in



㉙x1 46.1 in



㉚x2 47.2 in



㉛x2 21.7in

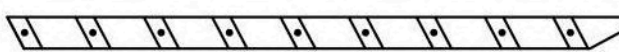

㉜x1 47.7in

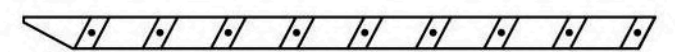

㉝x1 47.7in

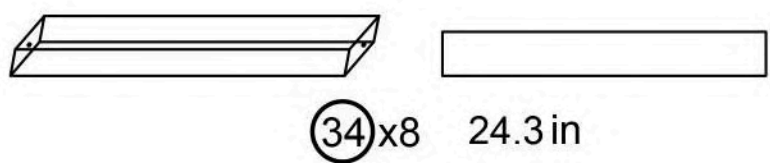

34x8 24.3 in

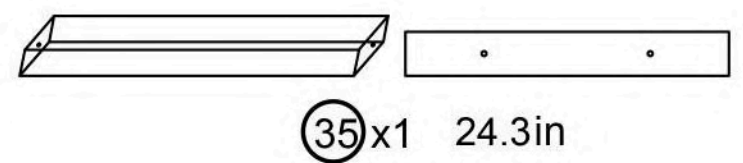

35x1 24.3 in

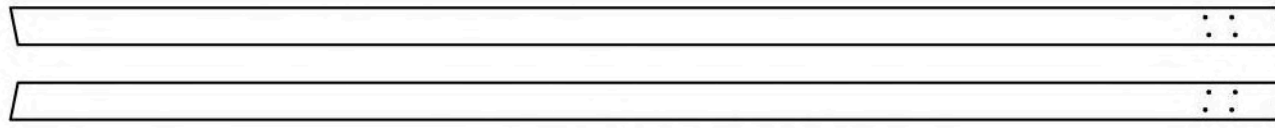

36x2 92.9 in

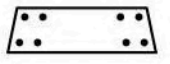

37x2 11.1 in

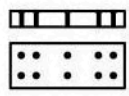

38x1 8.6 in

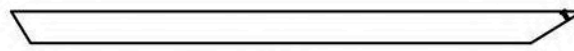

39x2 42.5 in

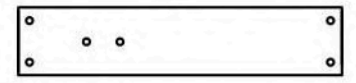

40x6 17.3 in

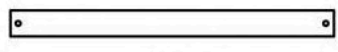

41x1 17.3 in

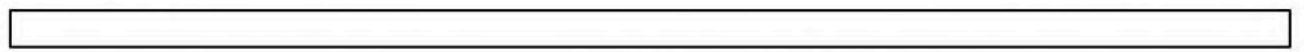

42x1 92.9 in

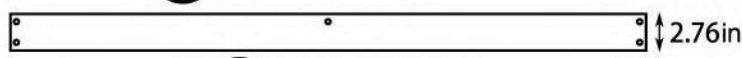

43x1 47.6 in

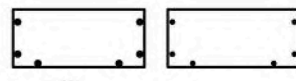

44x1 9.8 in

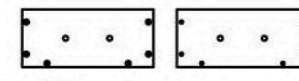

45x1 9.8 in

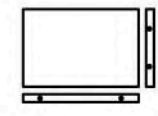

46x1 8.7 in

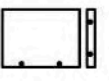

47x2 5.8 in

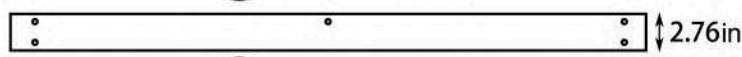

48x1 47.6 in

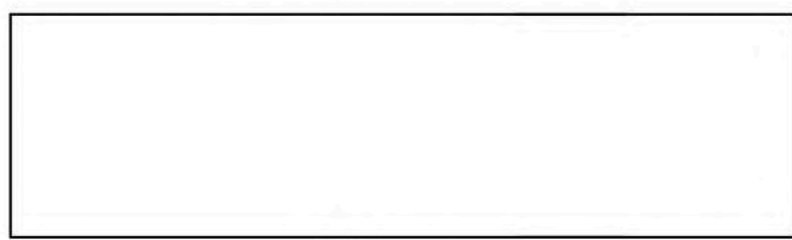

54x4

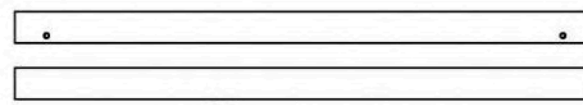

48x2 43.3 in

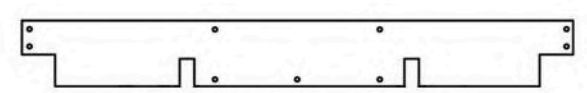

59x1 46.1 in

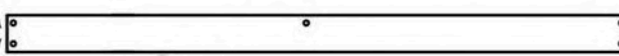

58x2 47.6 in

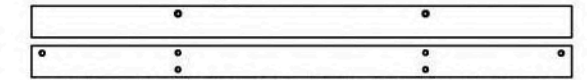

60x1 40.6 in

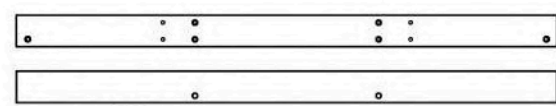

61x1 40.6 in

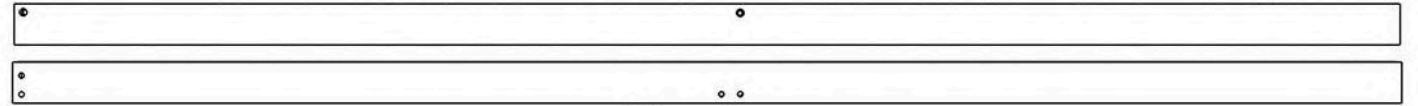

62x2 92.9 in



63x1 17.3 in

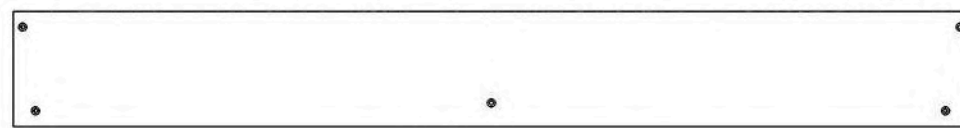

64x3 47.6 in

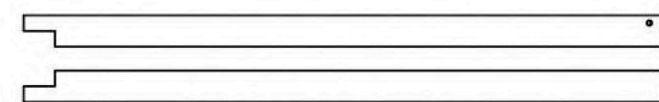

65x3 48 in

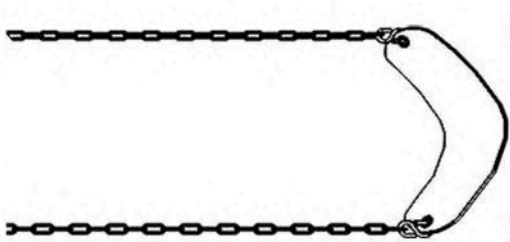

50x2

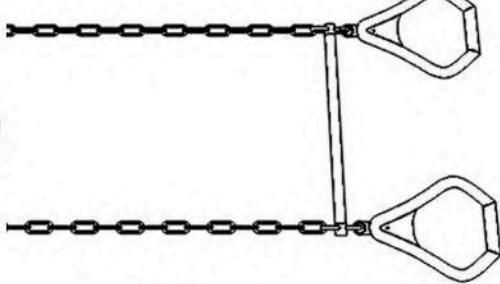

51x1

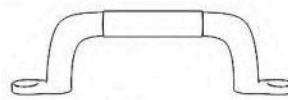

49x4



52x1



53x7



55x6

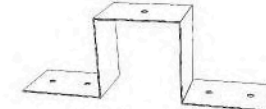

56x1



57x12

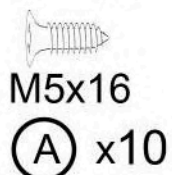

A x10

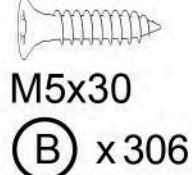

B x306

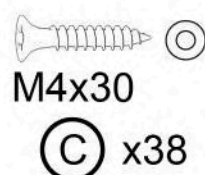

C x38

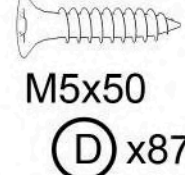

D x87

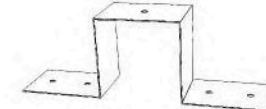

56x1

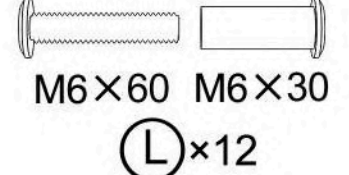

L x12

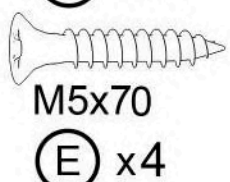

E x4

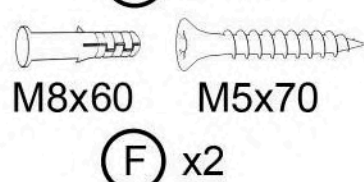

F x2

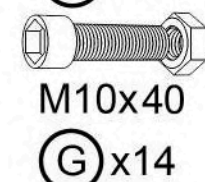

G x14

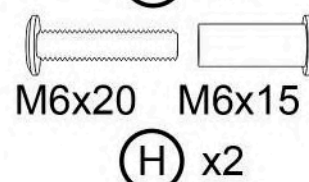

H x2

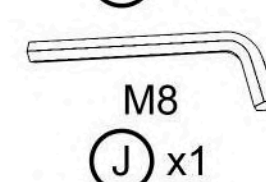

56x1

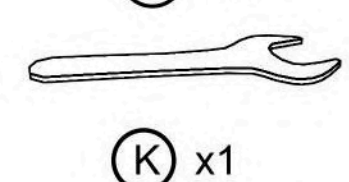

57x12

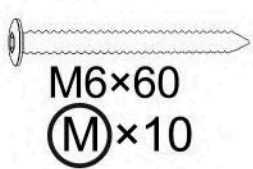

M x10

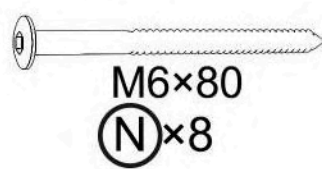

N x8

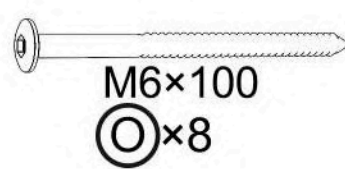

O x8

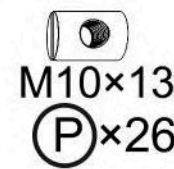

P x26

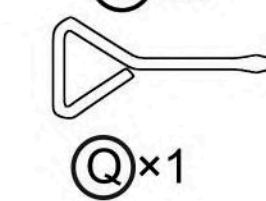

56x1

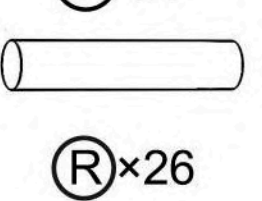

57x12

TOOLS NEEDED



cement

barrel of cement

A1-1

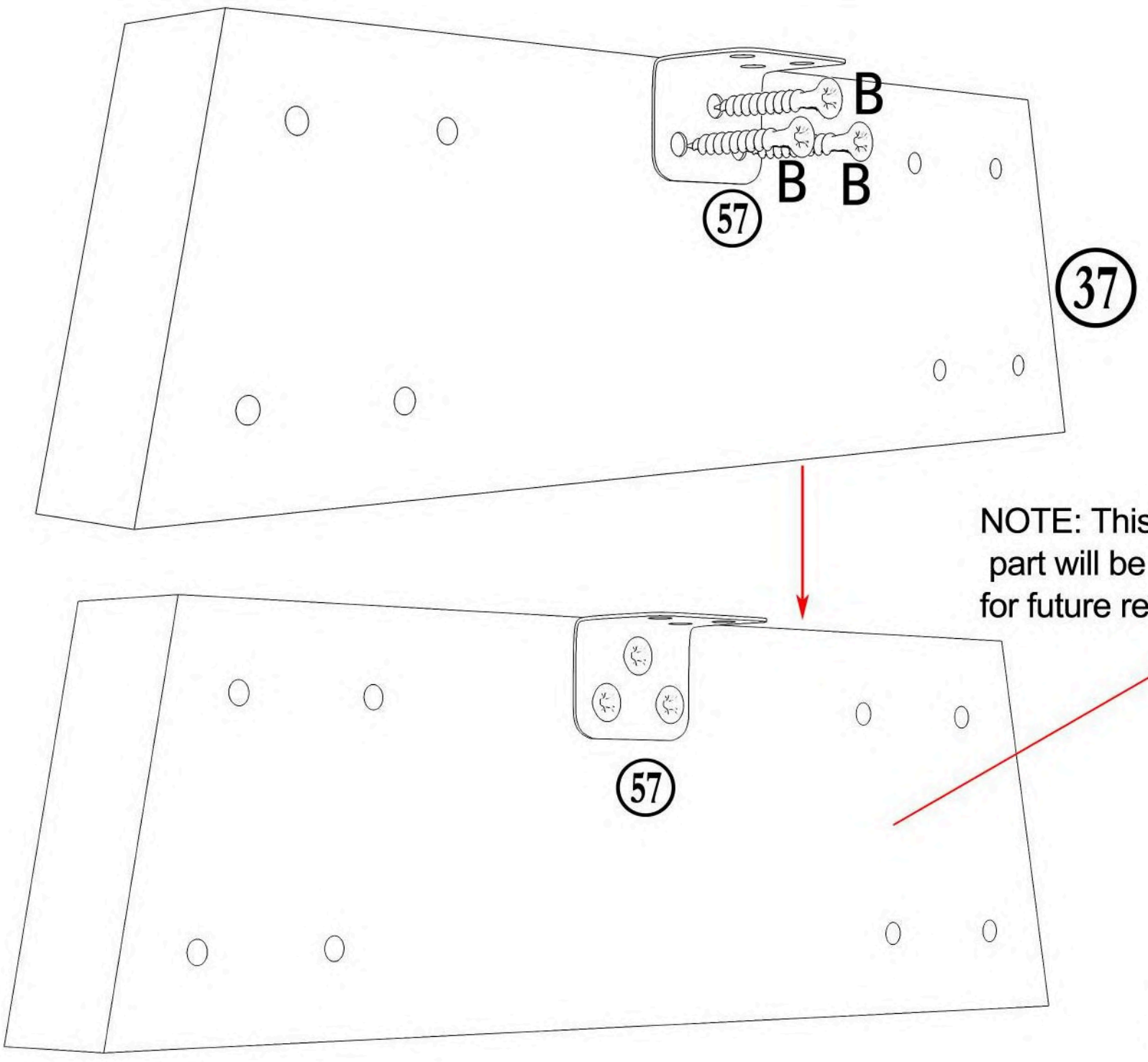

NOTE: This completed part will be noted as A1-1 for future reference

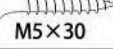
(57)		1
B	 M5x30	3

A2-1

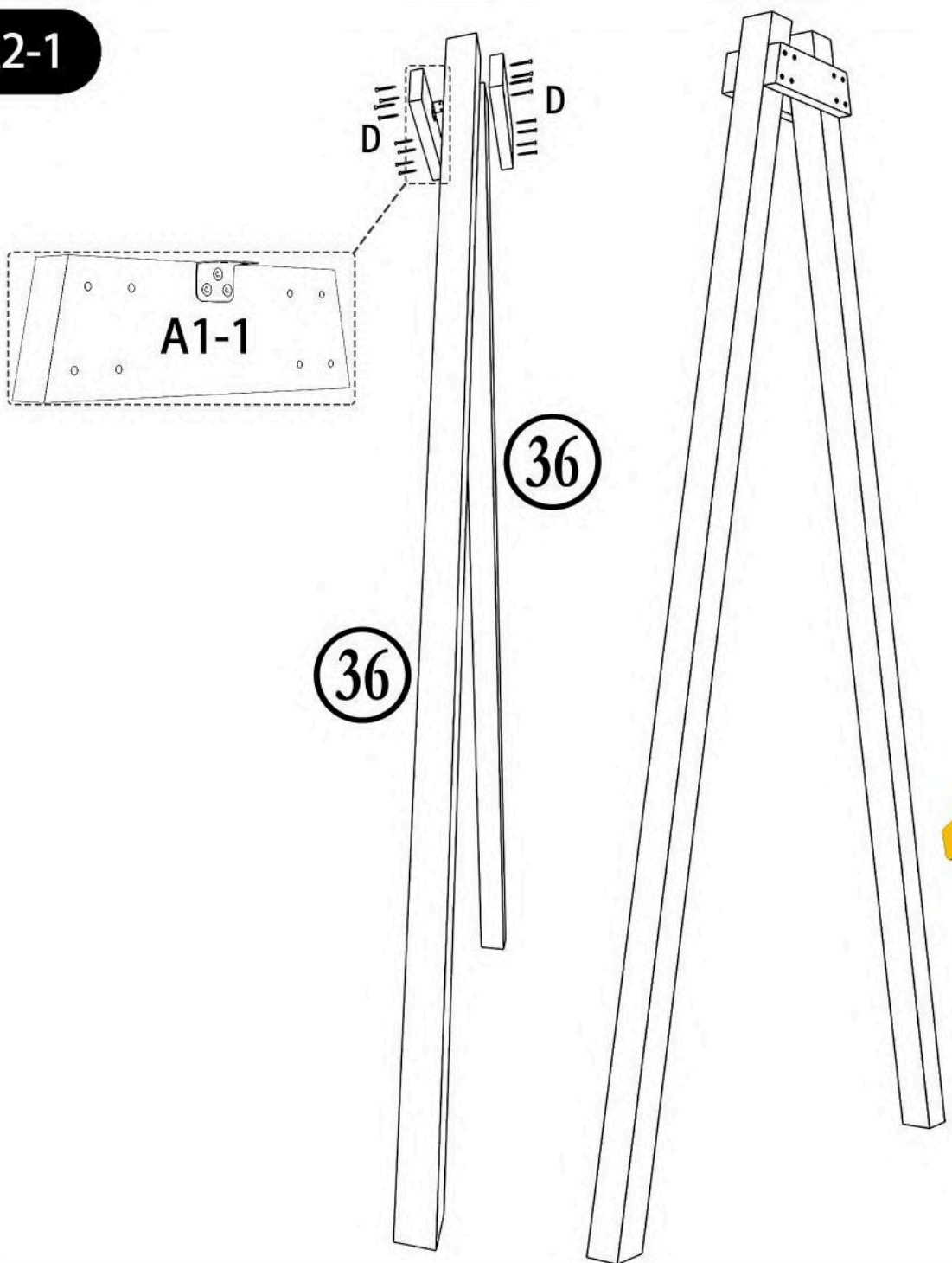

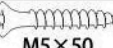
D	 M5x50	16
---	---	----

A3-1

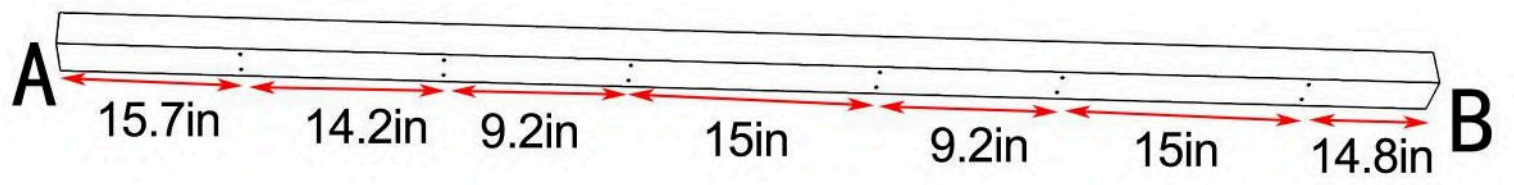
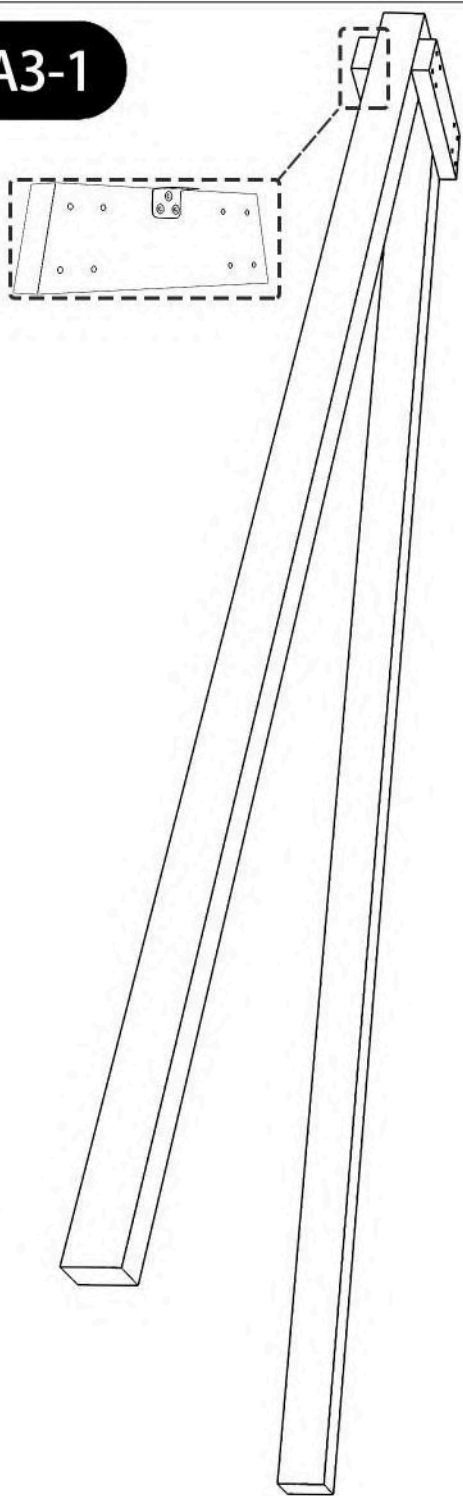

42

NOTE: Confirm point A & B by measuring the distance at each end to the predrilled holes. Point A is 15.7" whereas point B is 14.8"

A3-2

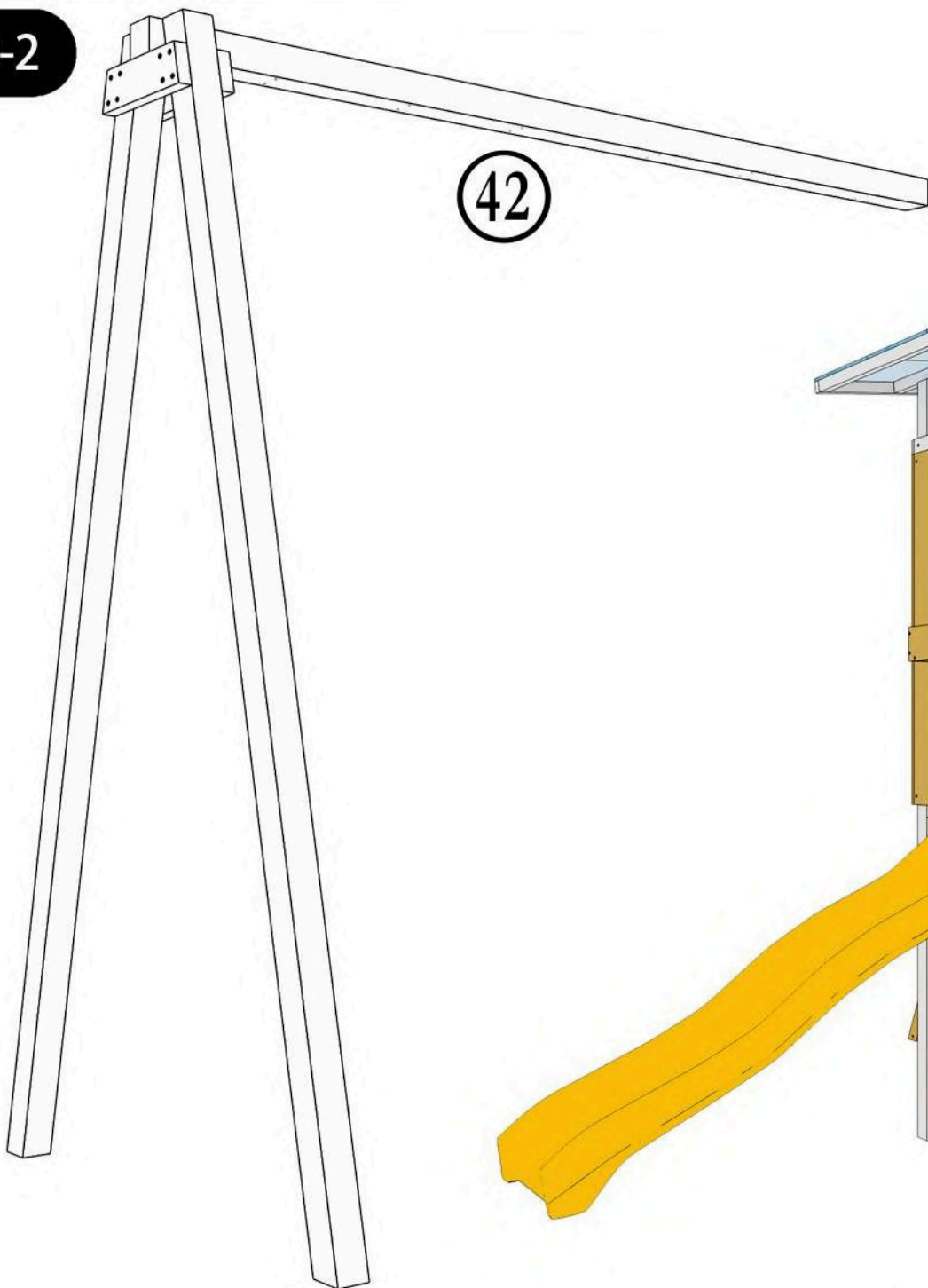

42



A4-1

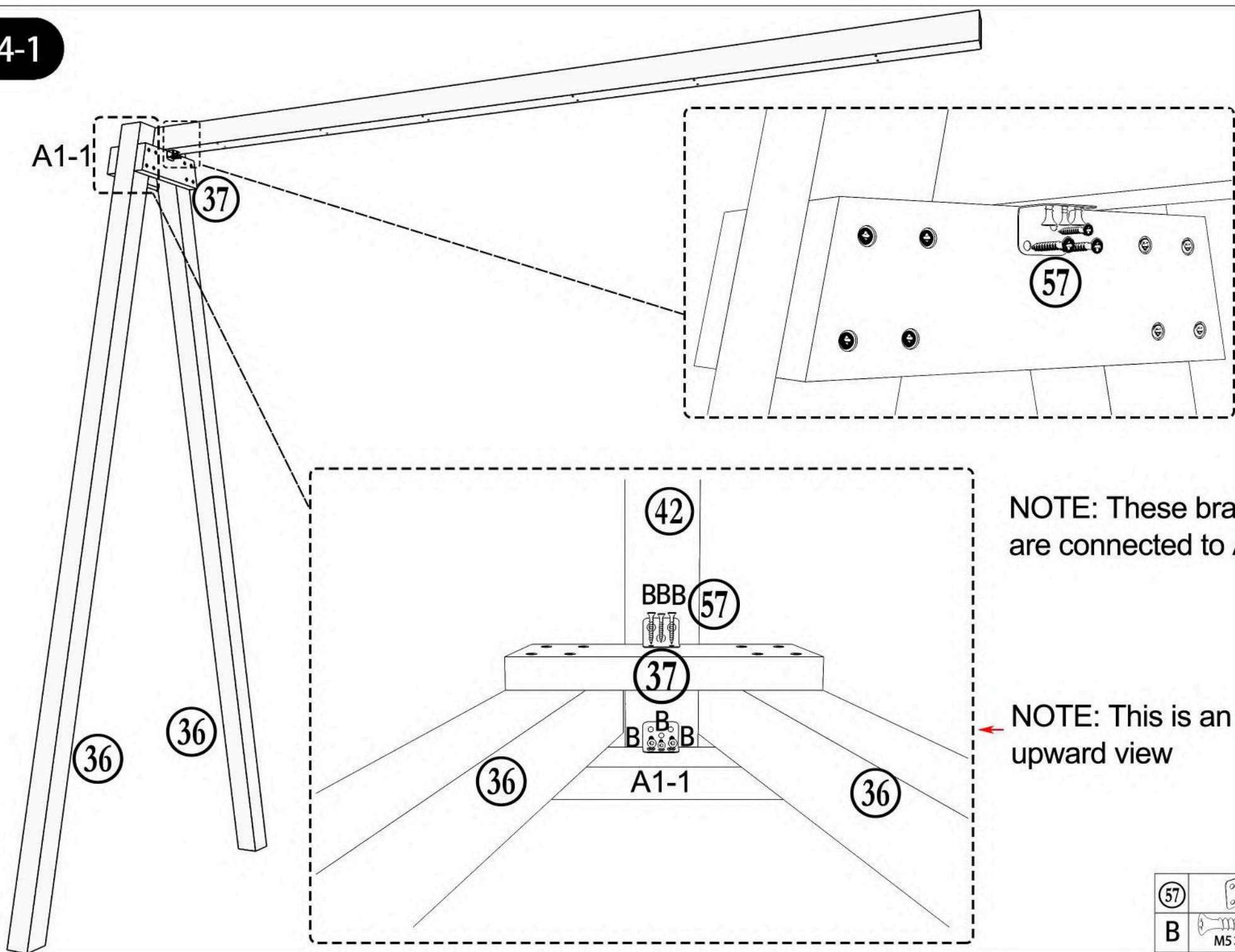

NOTE: These brackets are connected to A1-1

NOTE: This is an upward view

57		1
B	M5x30	9

A4-2

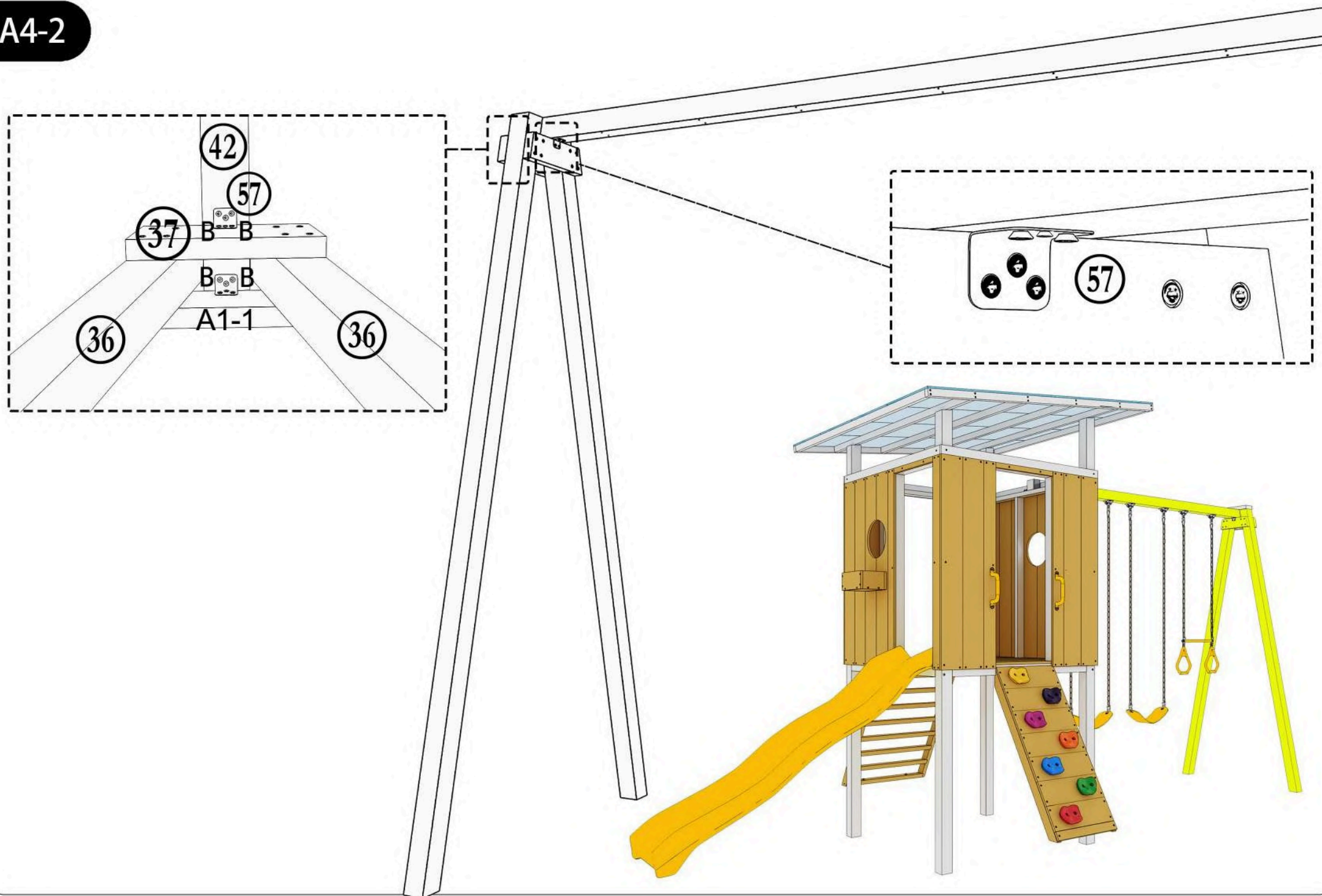

A5-1

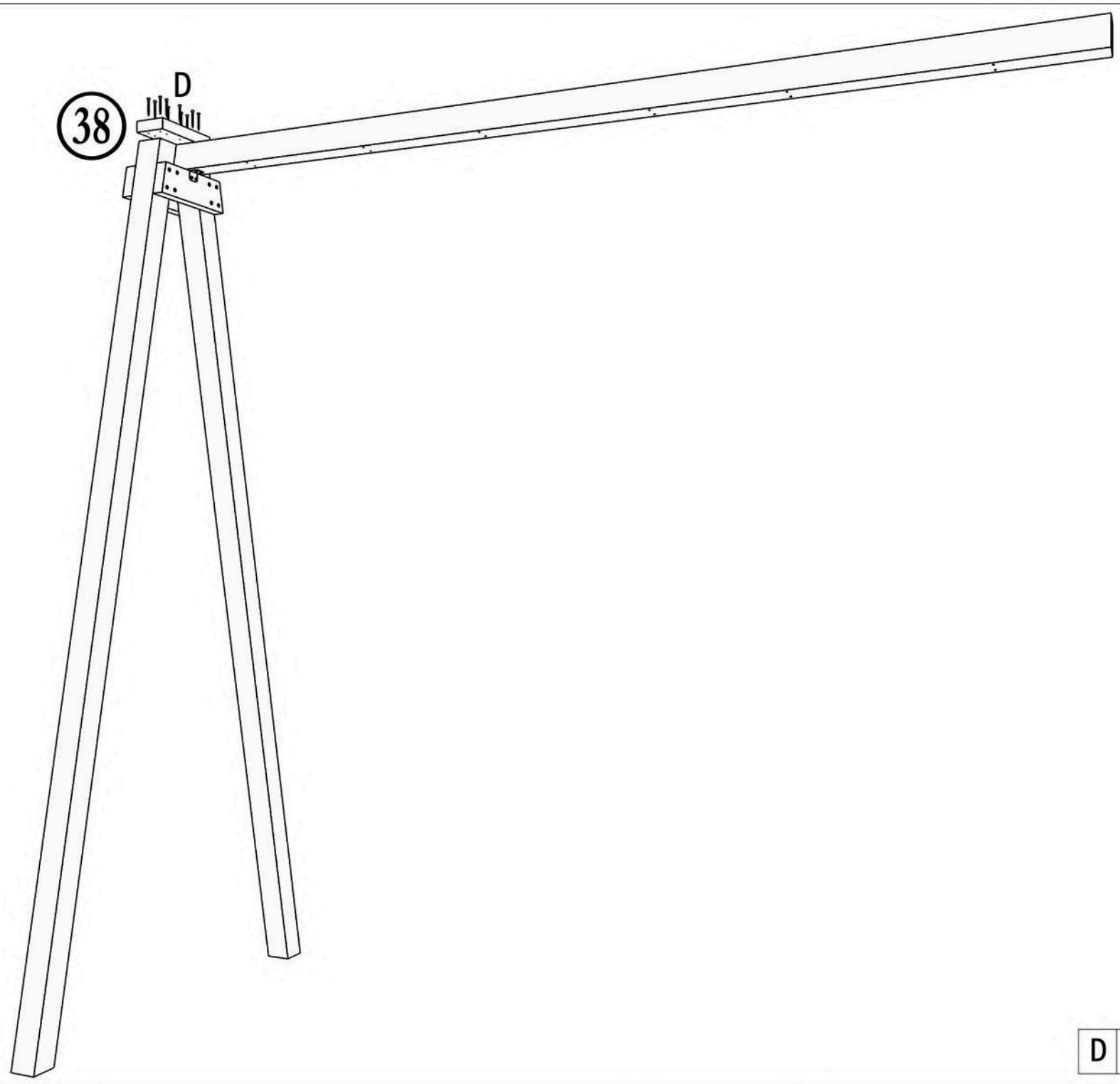

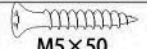

D		10
	M5x50	

A5-2

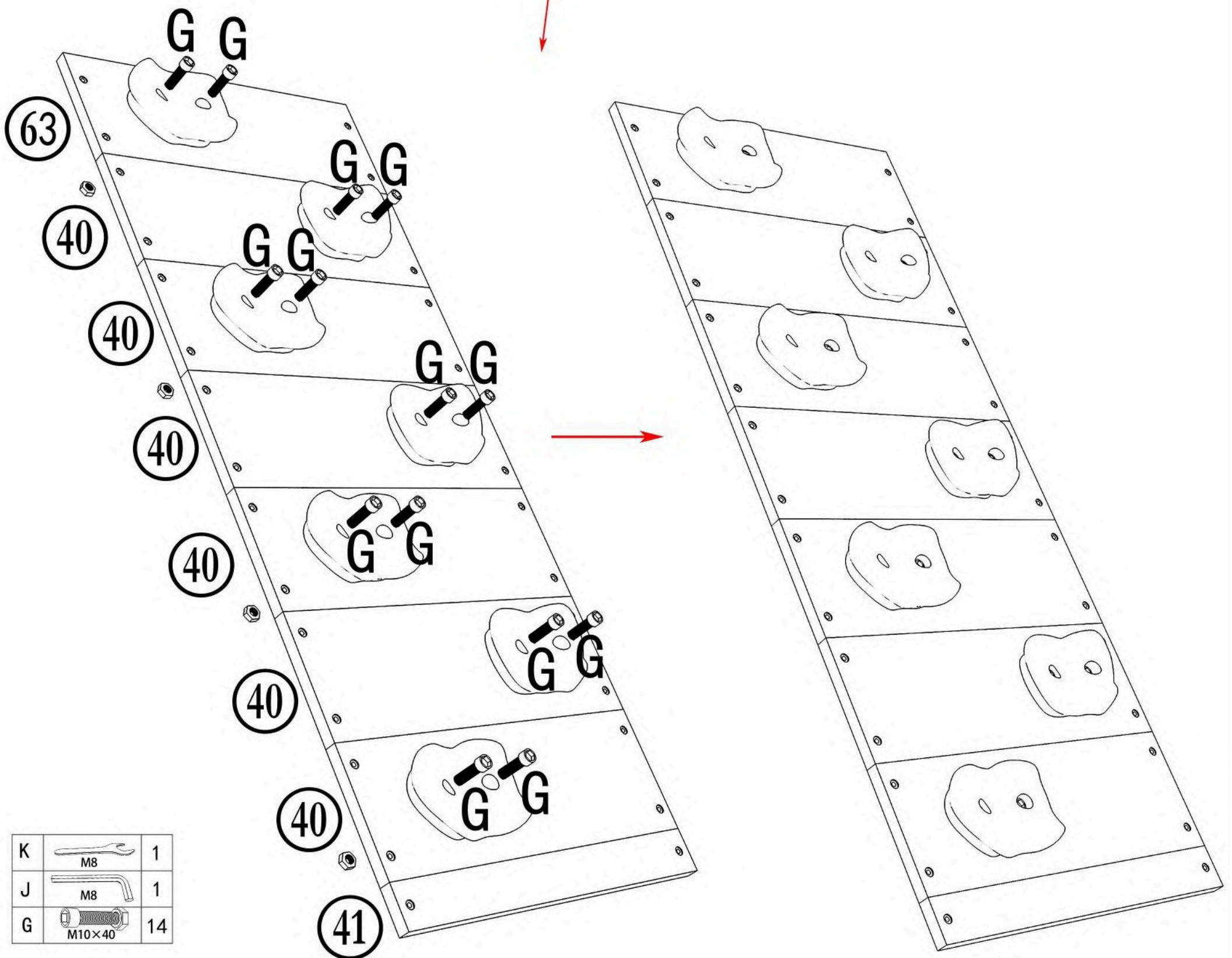
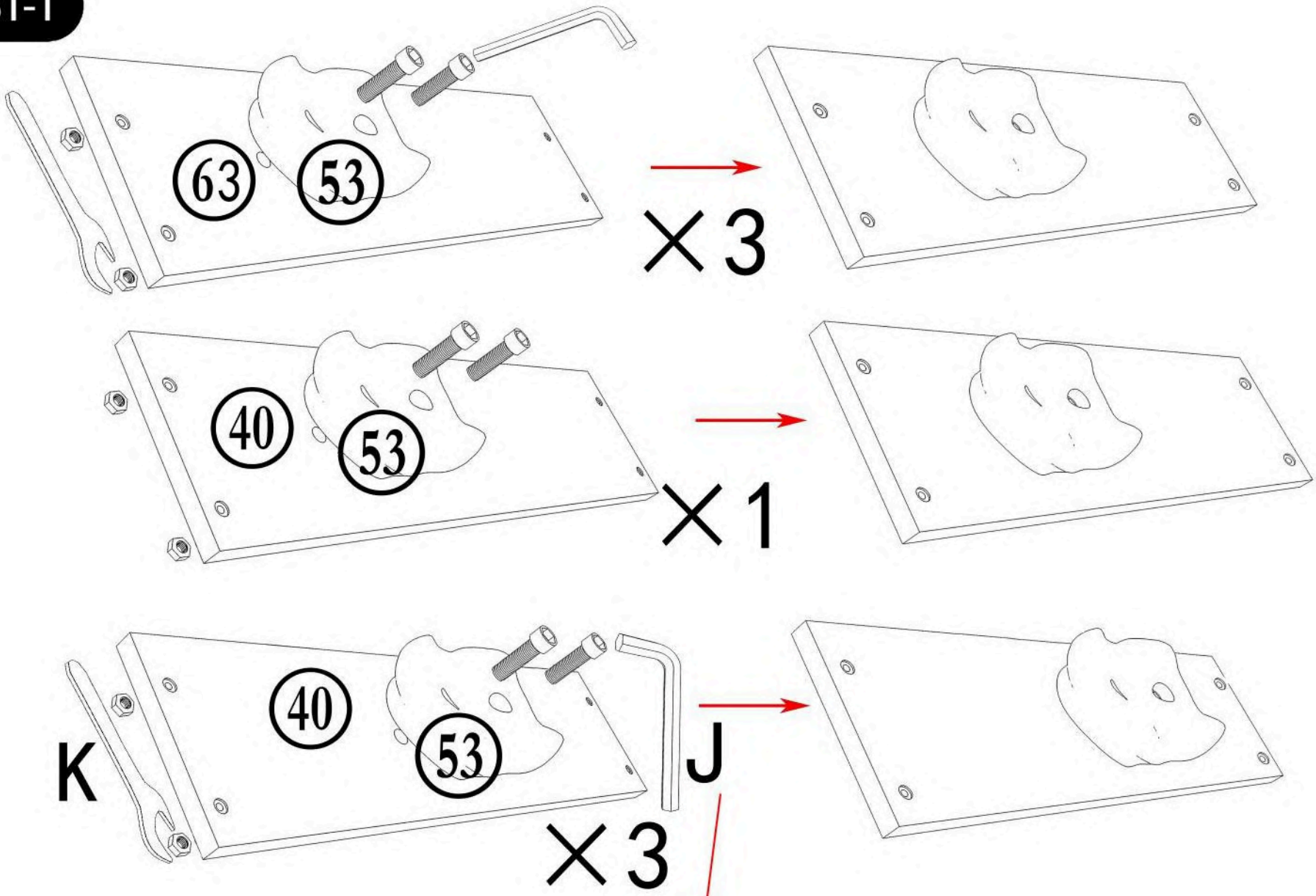



K		M8	1
J		M8	1
G		M10×40	14

B2-1

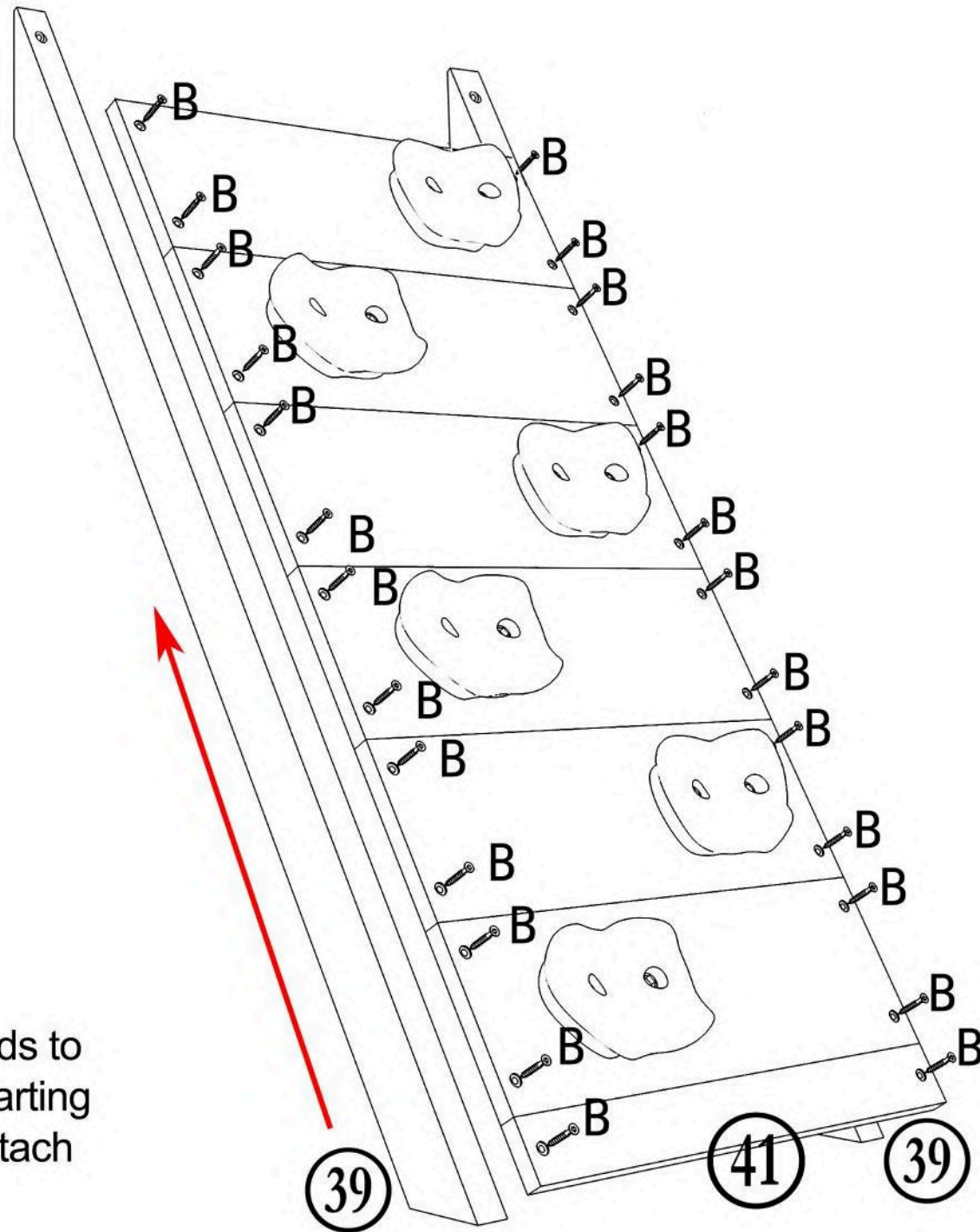

NOTE: Screw the boards to Parts 39 one by one starting at the bottom. Do not attach Part 63 yet.

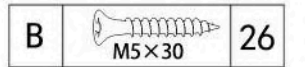

B2-2

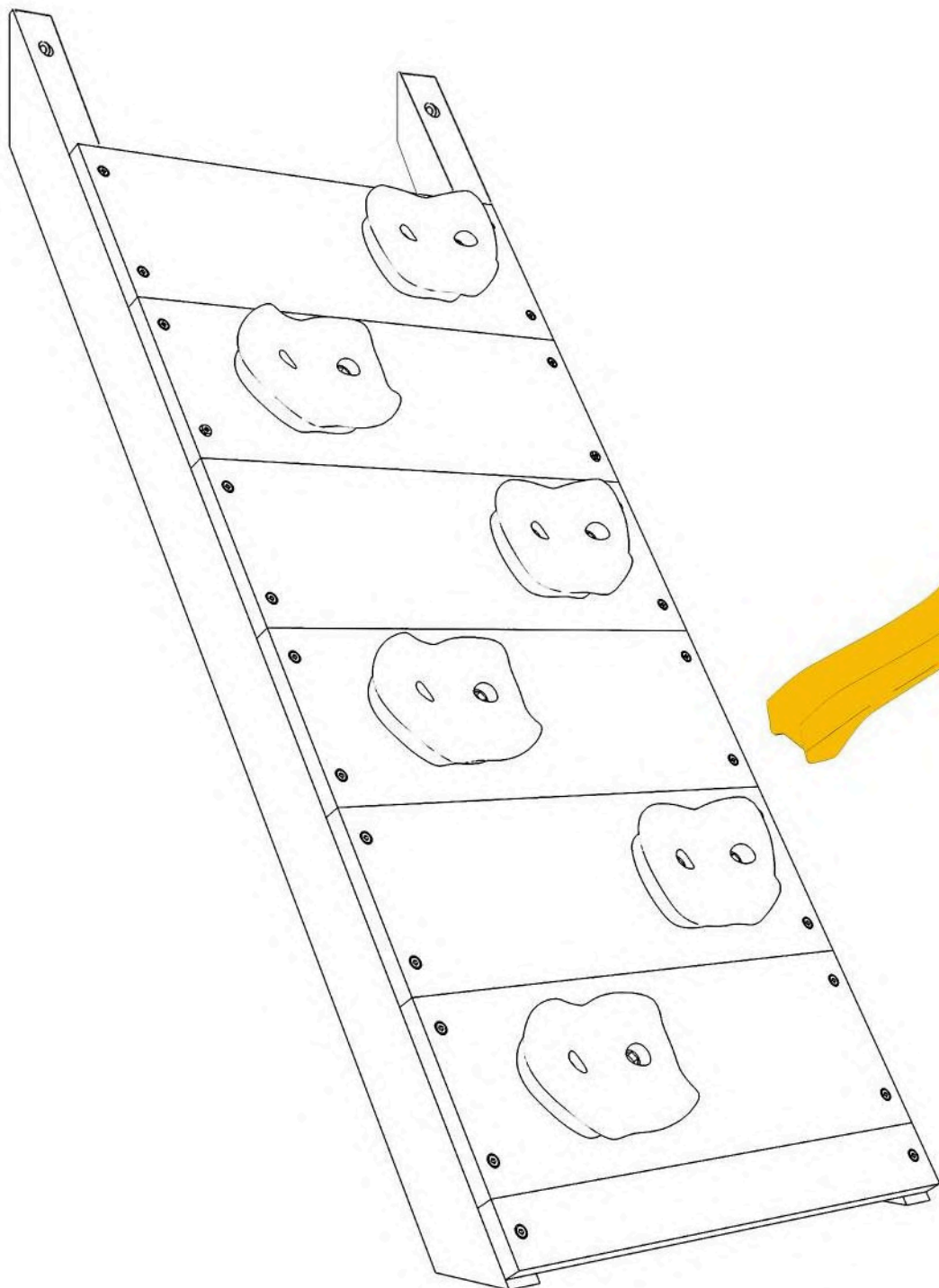

NOTE: This finished section will be referred to as "Rock Wall B2"

C1-1

Build part of the "Sun Shield C1"

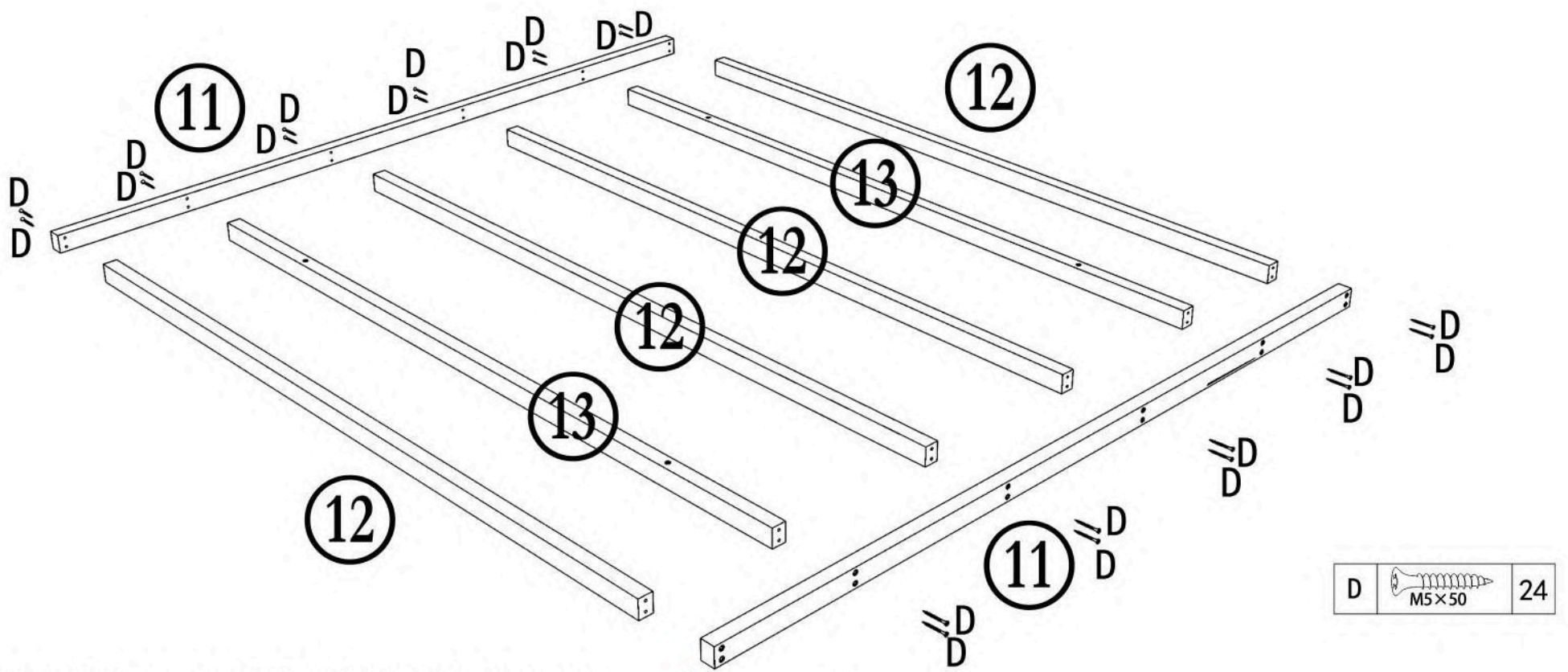

NOTE: Part 13 has predrilled holes facing up

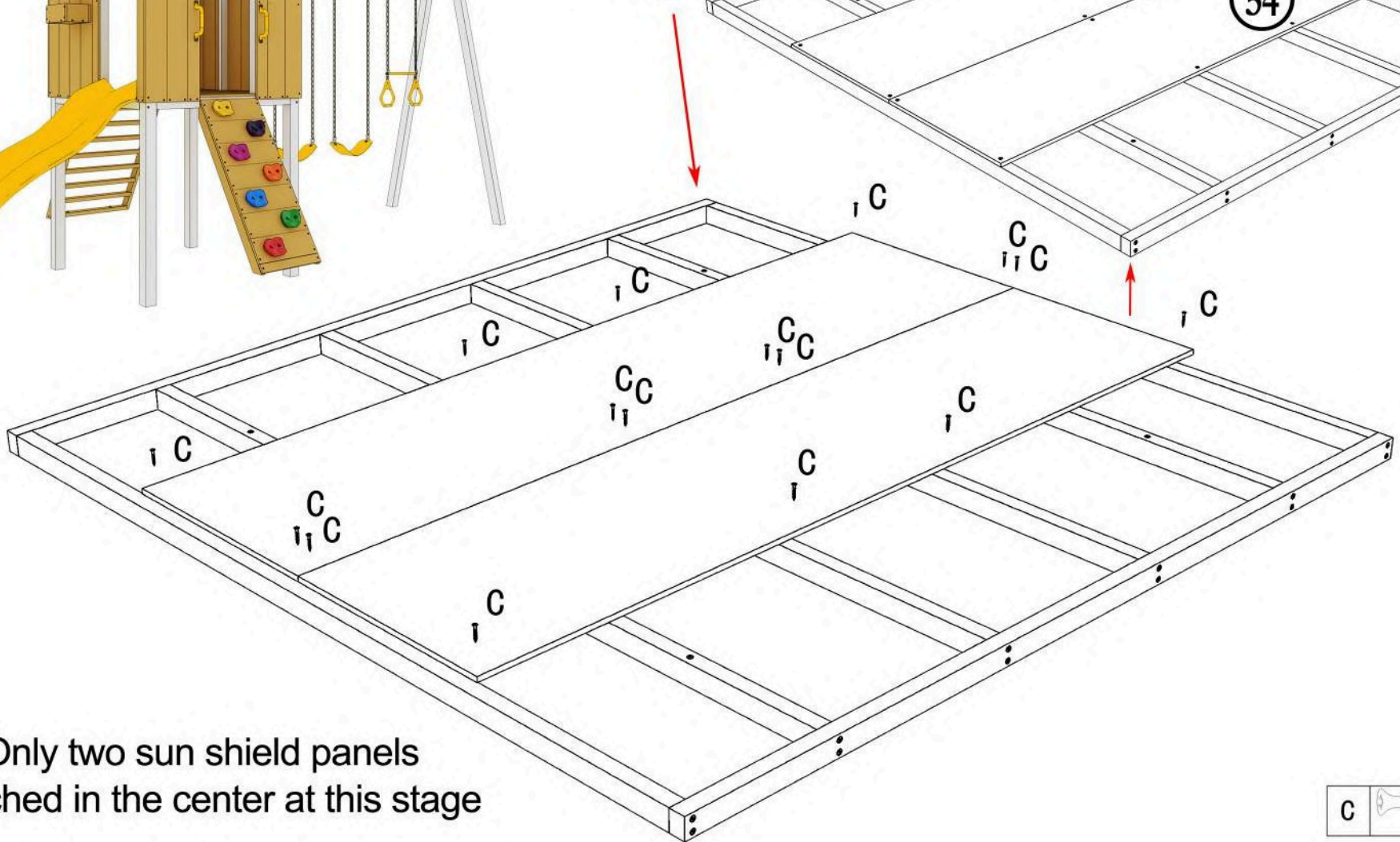
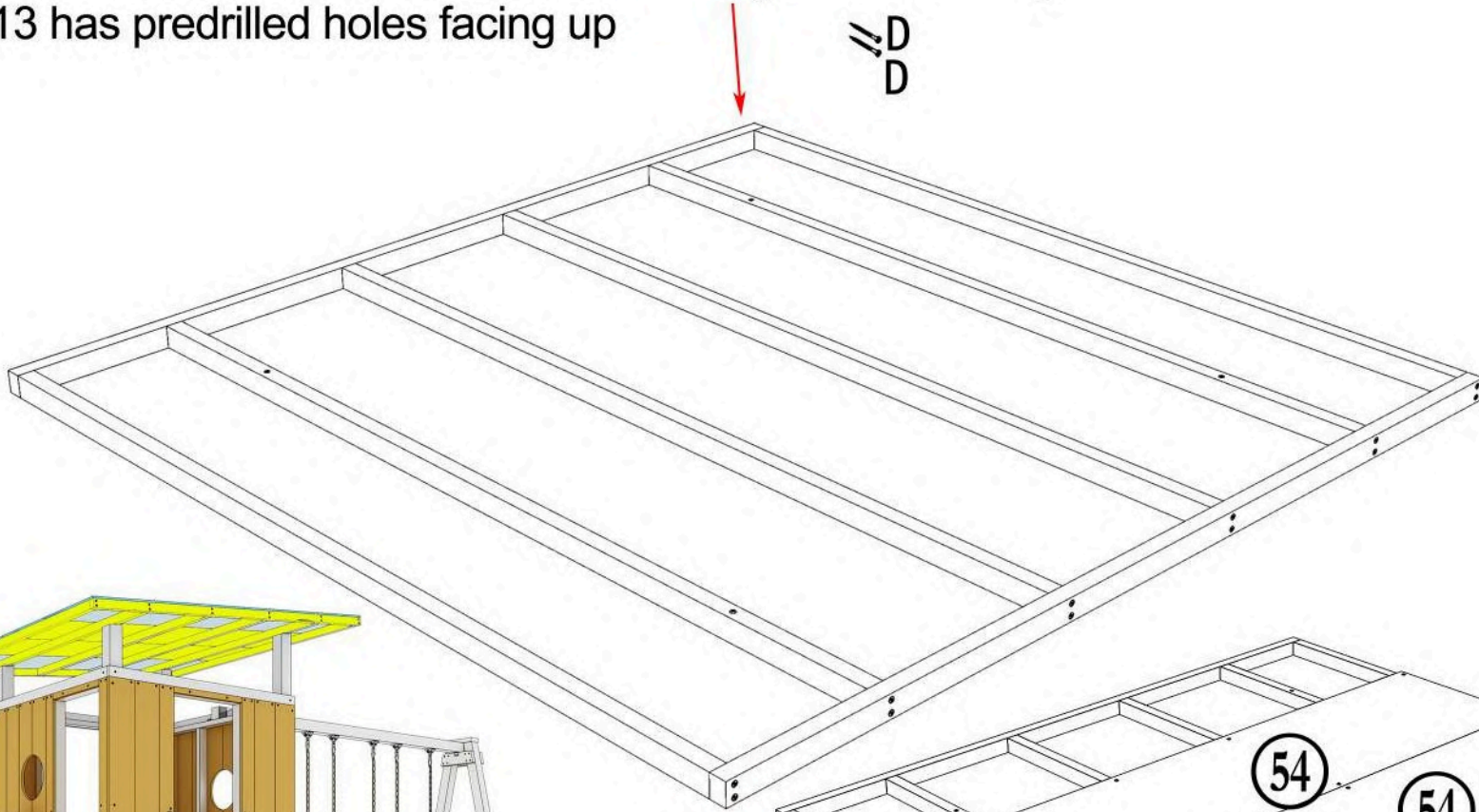

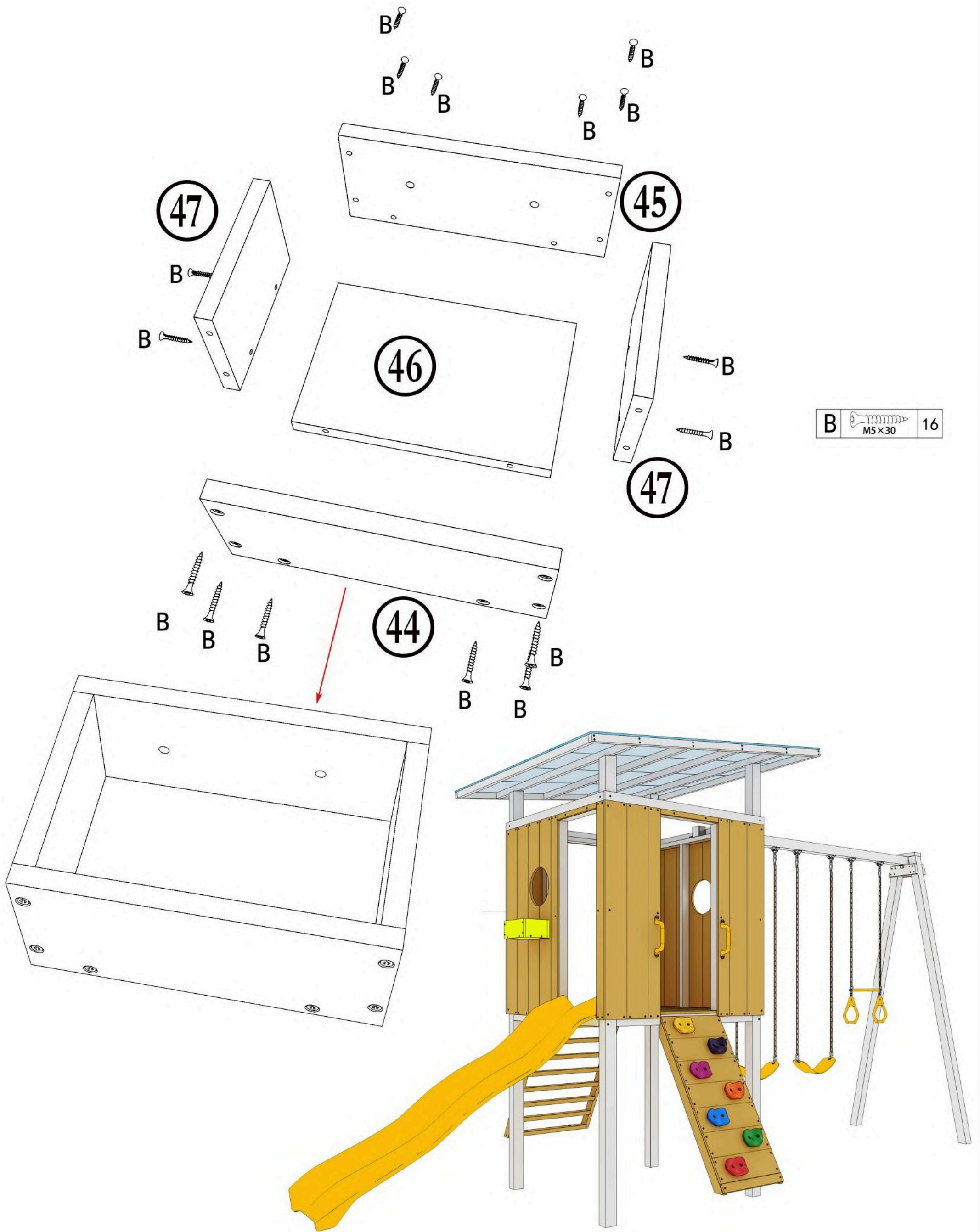

NOTE: Only two sun shield panels are attached in the center at this stage

Build the "Flower Box"

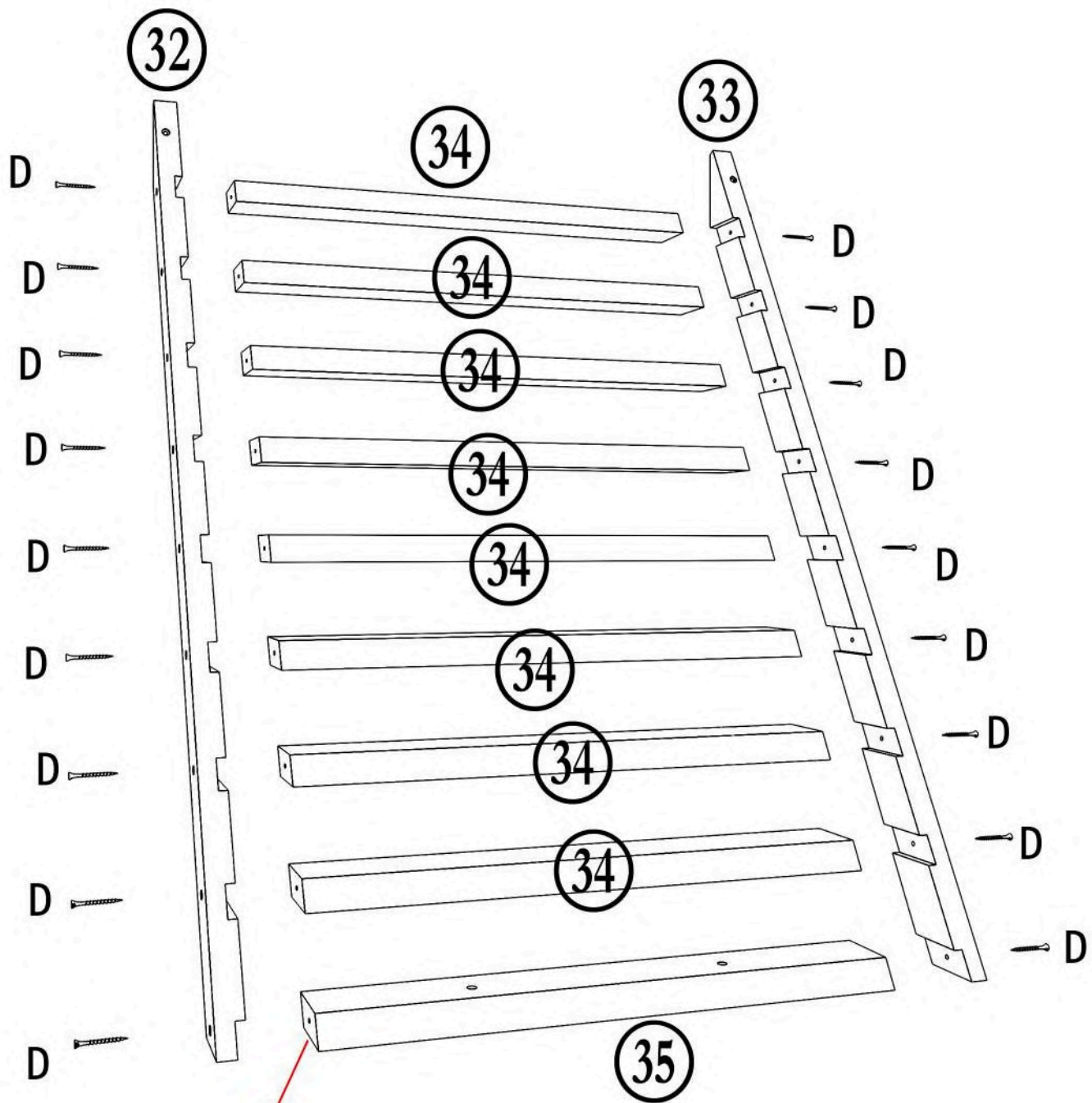

Build the Ladder



D		MSx50	18
---	---	-------	----

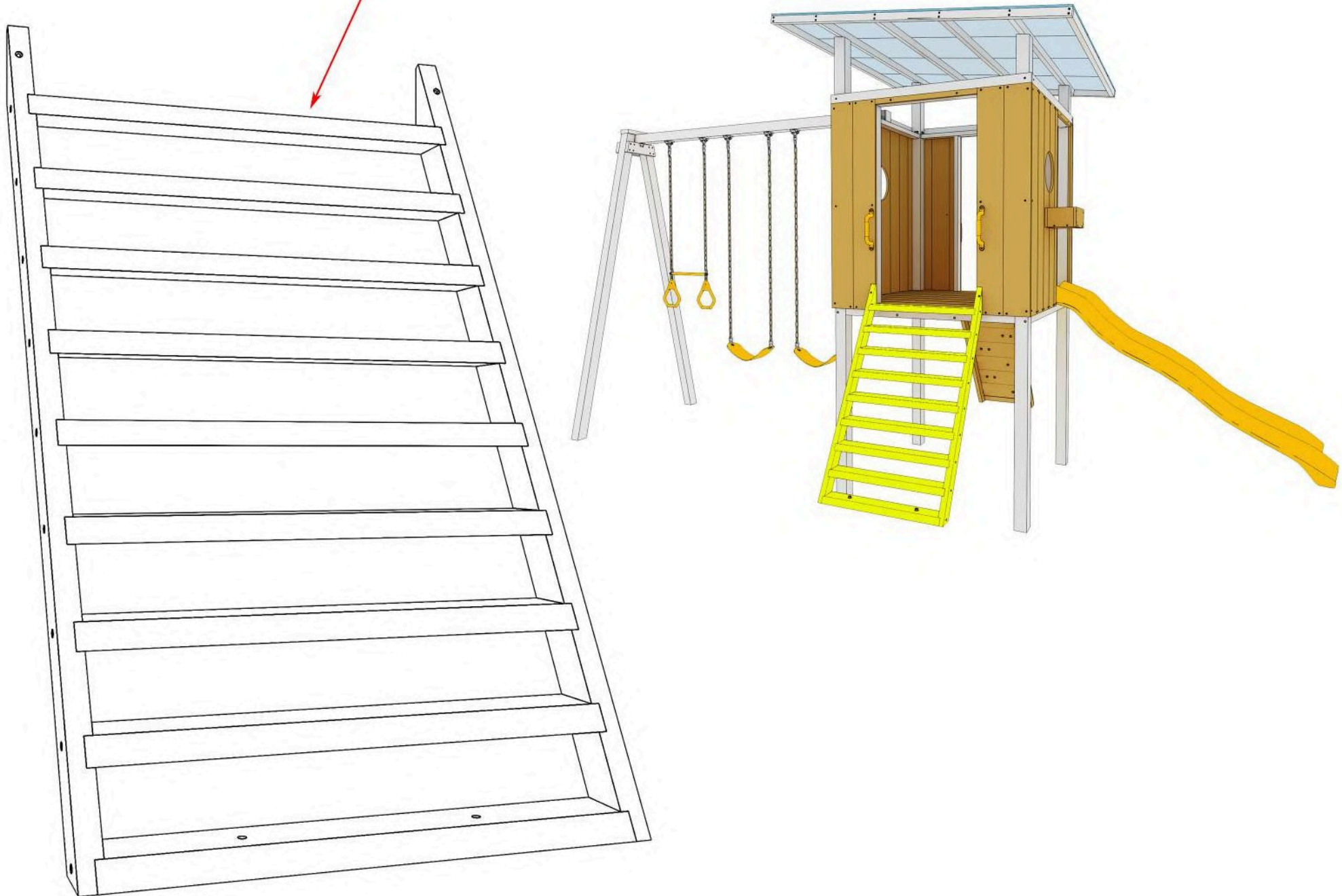

F1-1

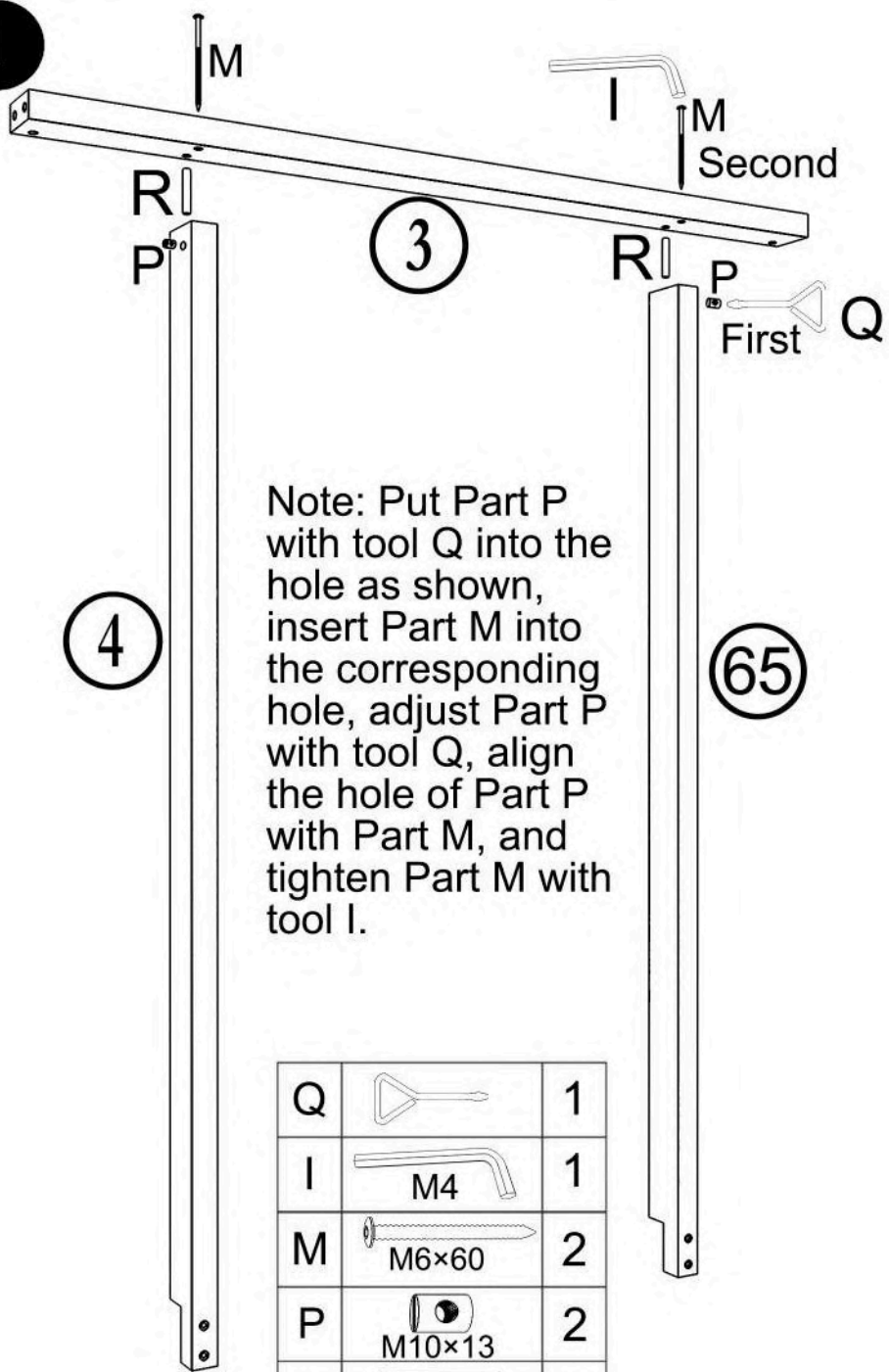

Note: Put Part P with tool Q into the hole as shown, insert Part M into the corresponding hole, adjust Part P with tool Q, align the hole of Part P with Part M, and tighten Part M with tool I.

Q		1
I		1
M		2
P		2
R		2

F1-2

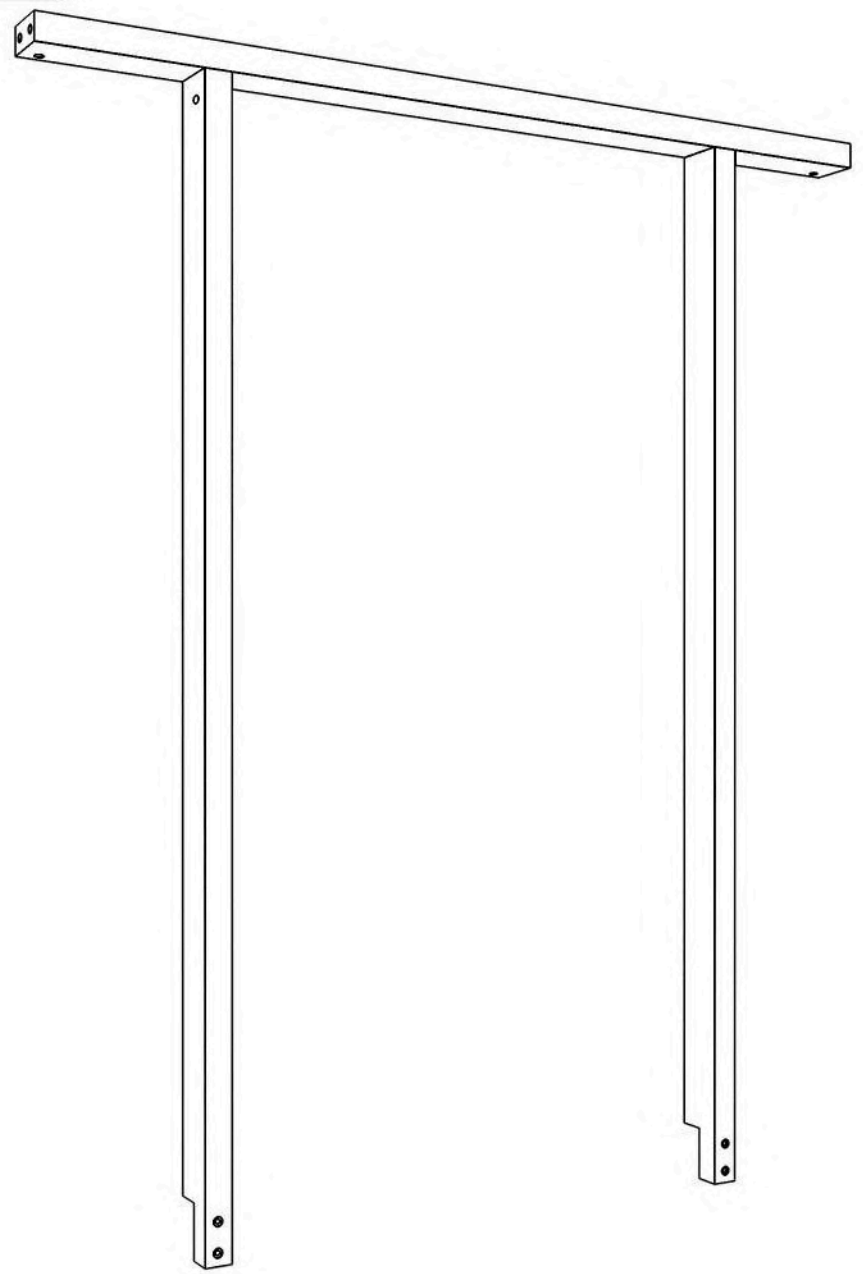

F2-1

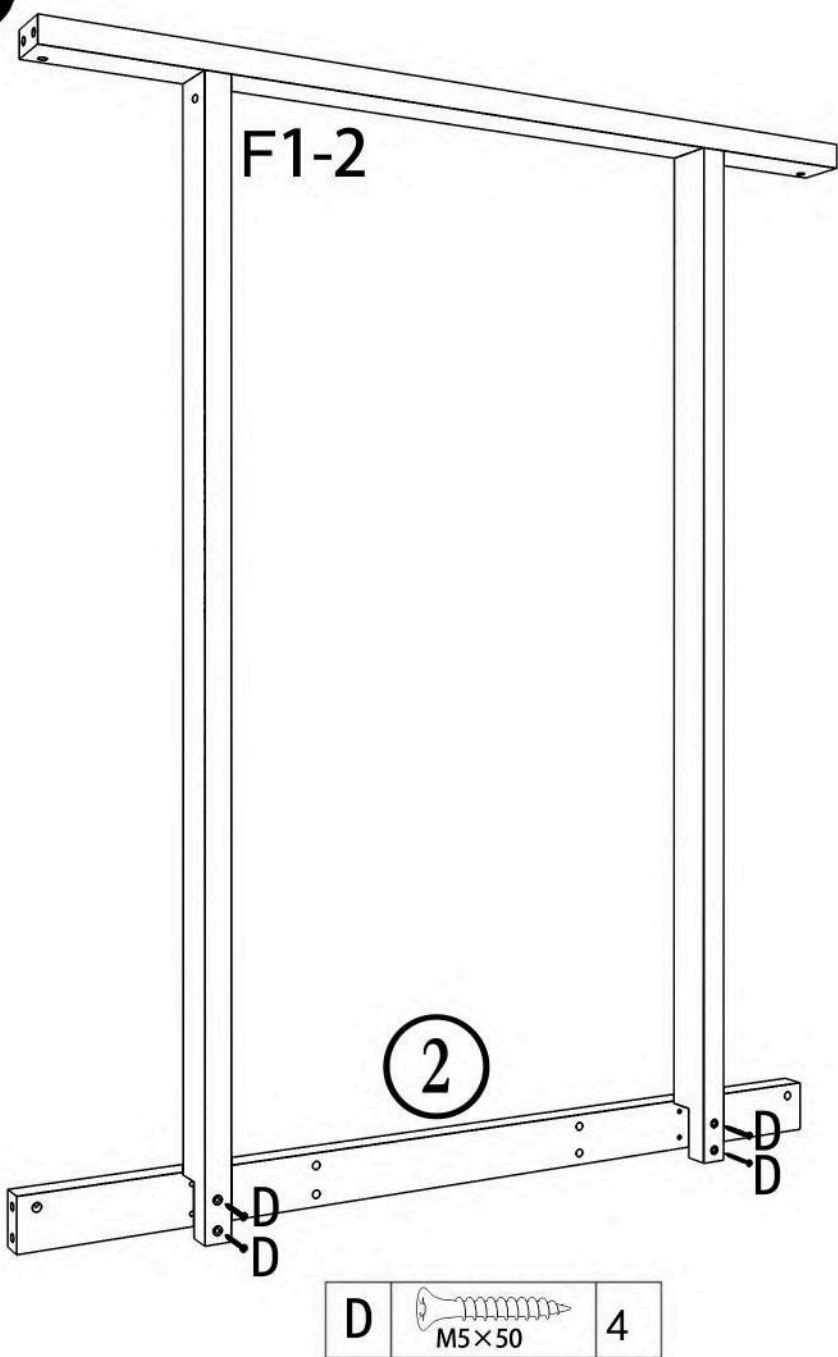

D		4
---	--	---

F2-2



F3-1

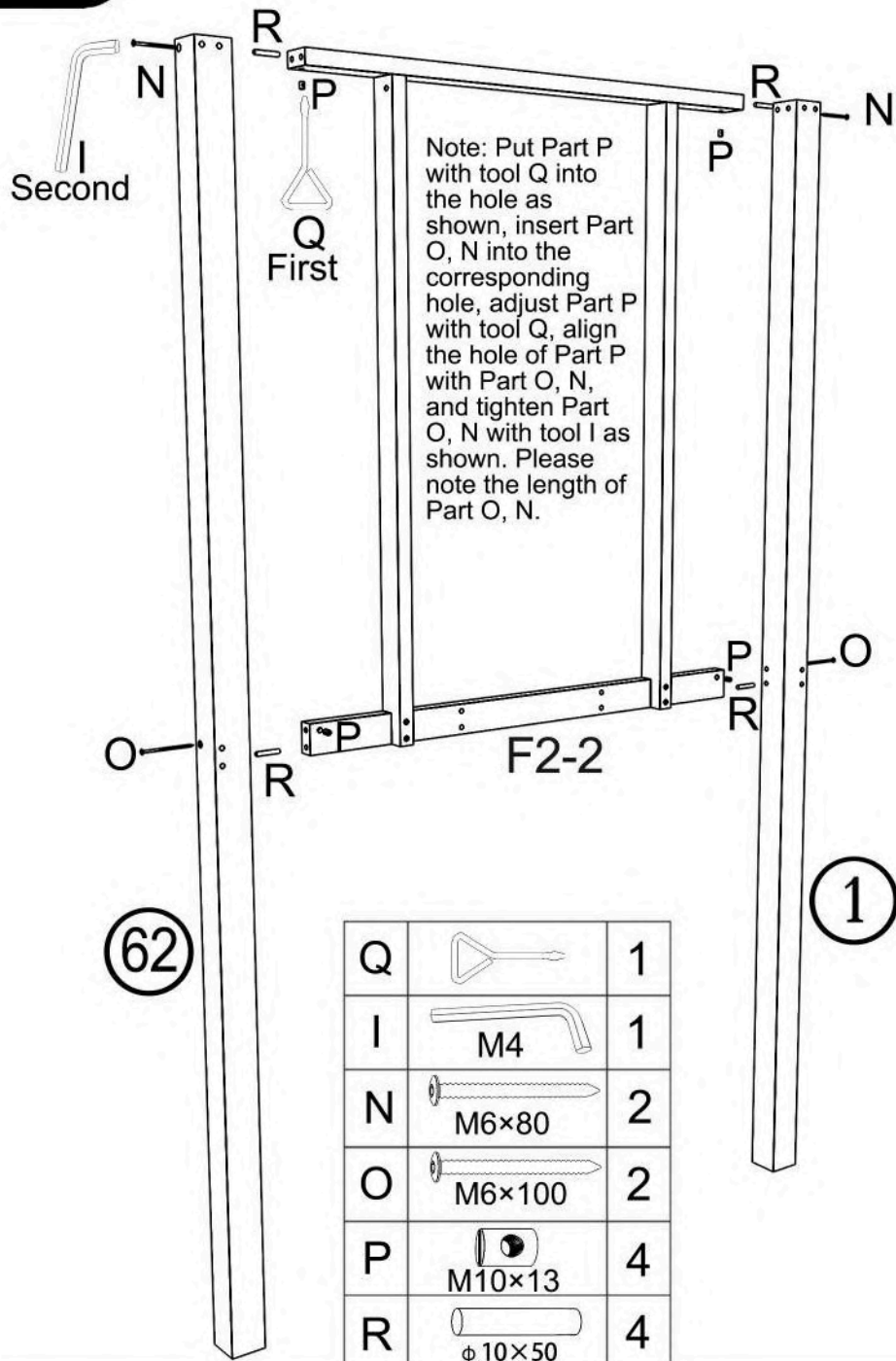

F3-2

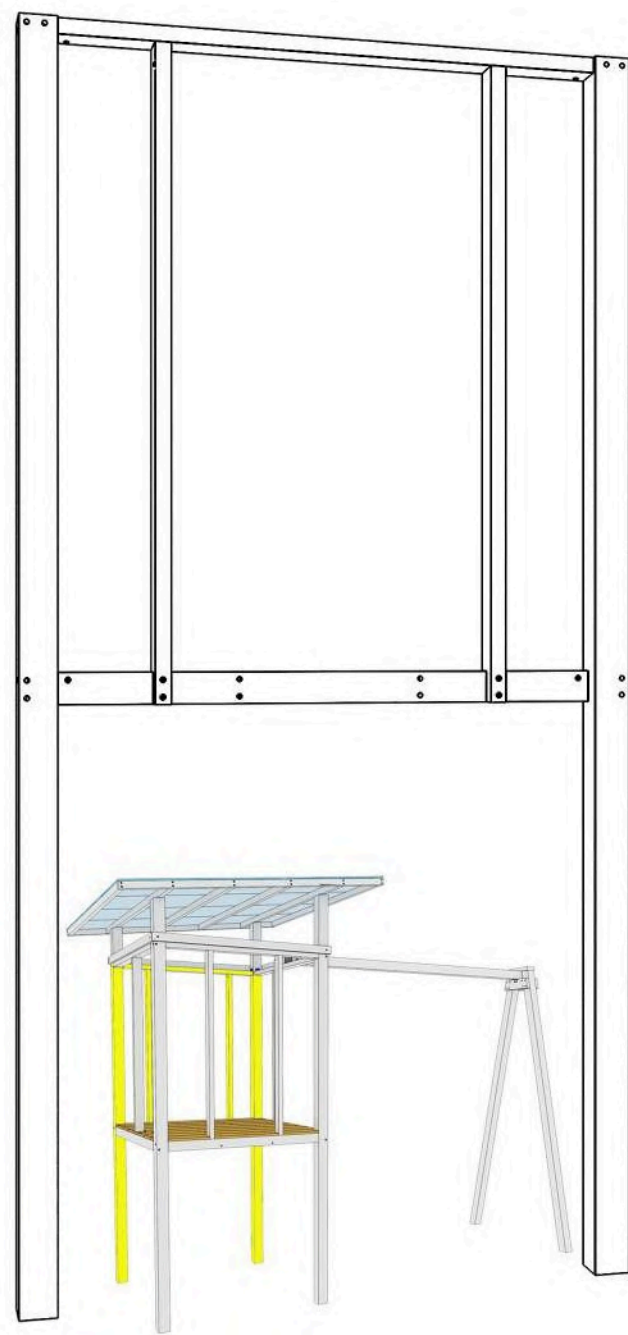

F4-1

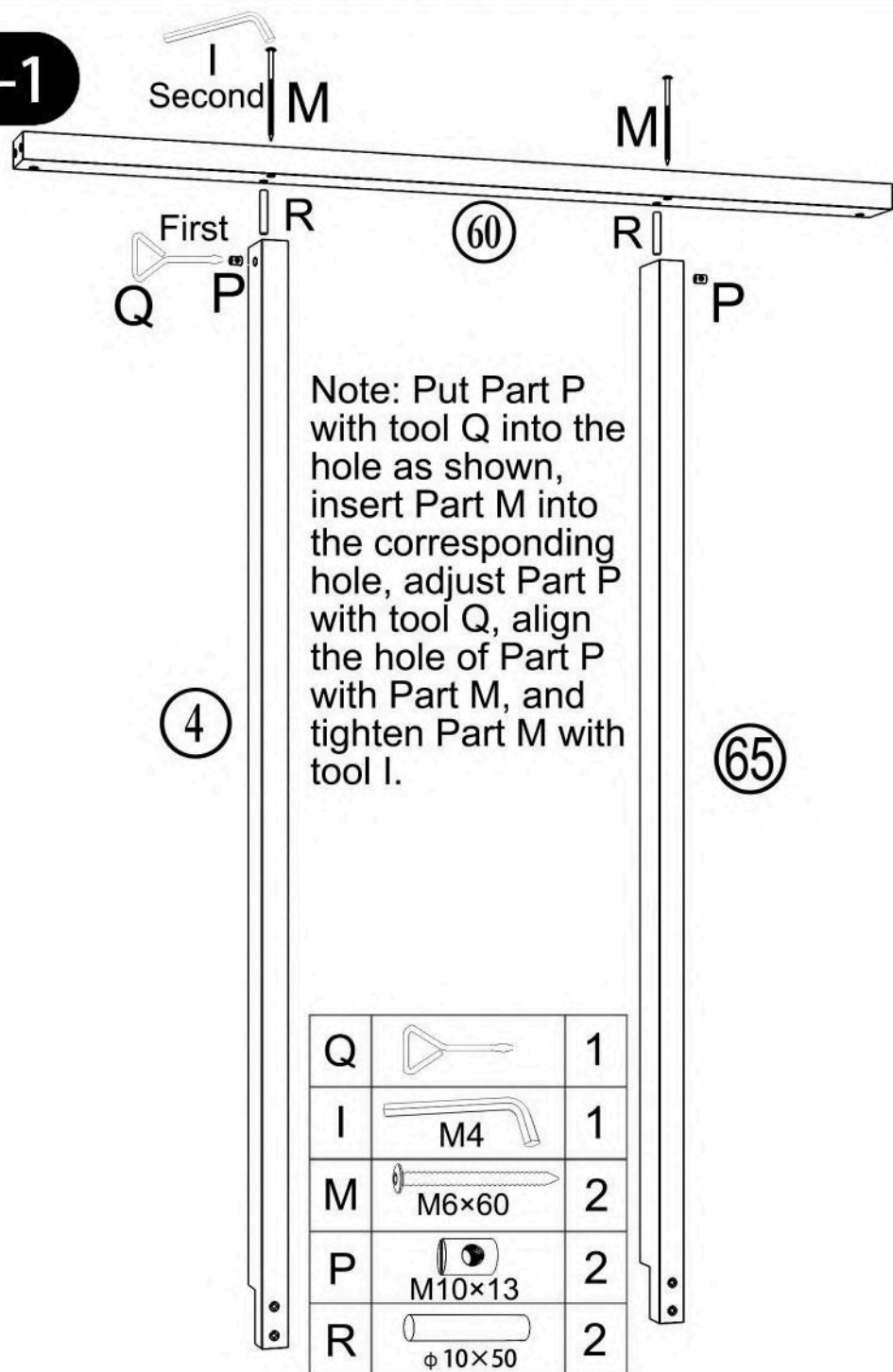

F4-2



F5-1

D  M5×50 **4**

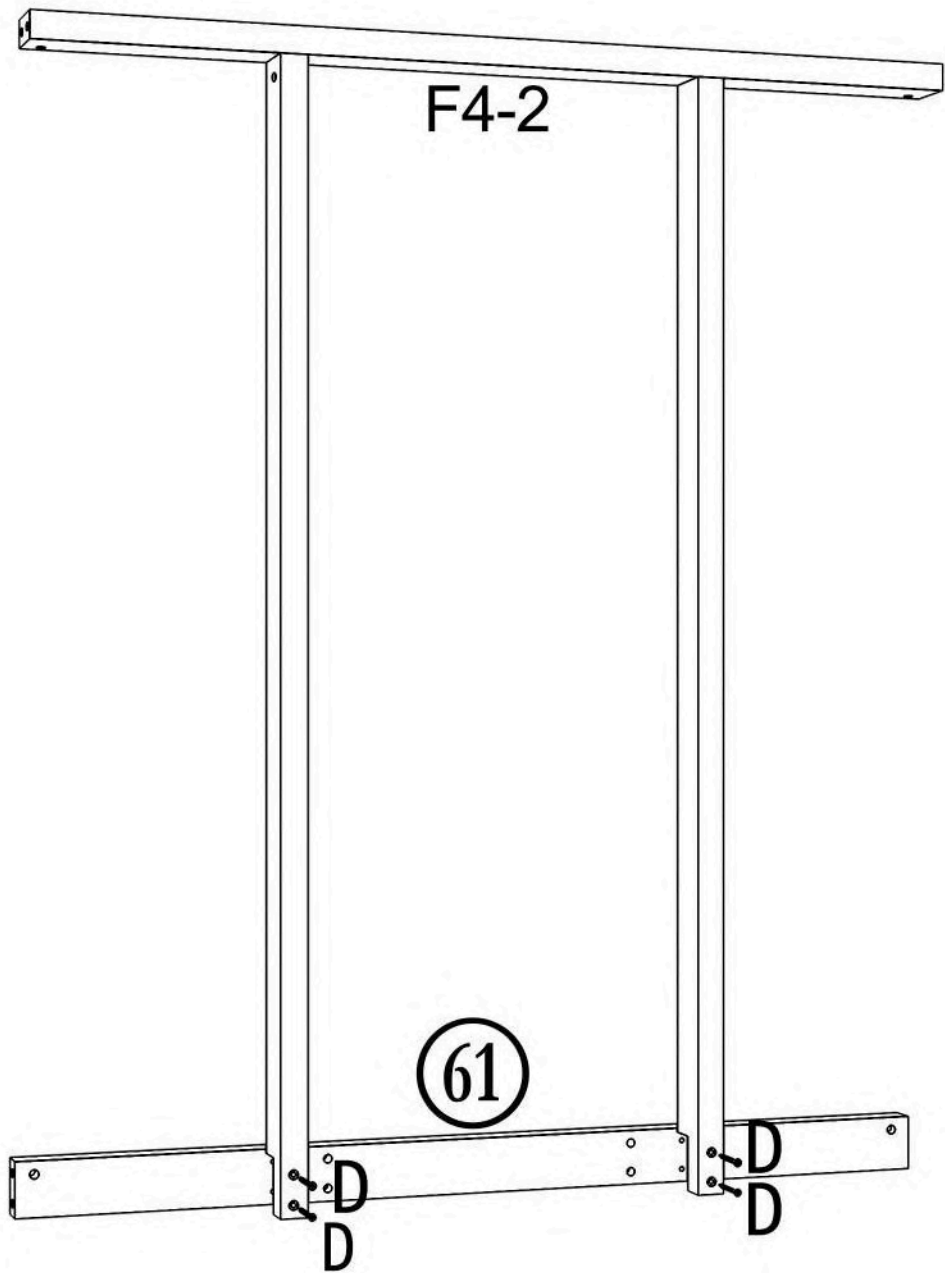

F5-2

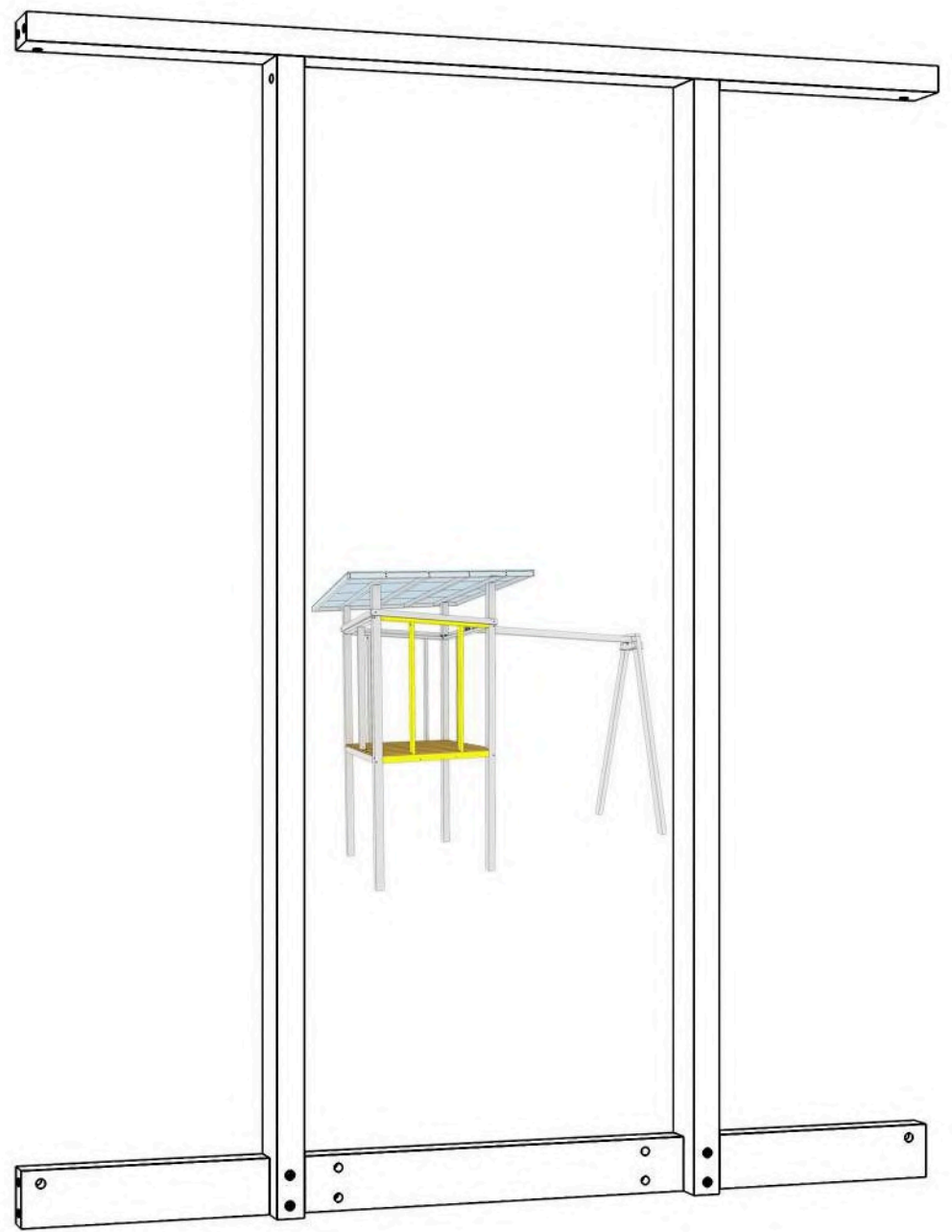

F6-1

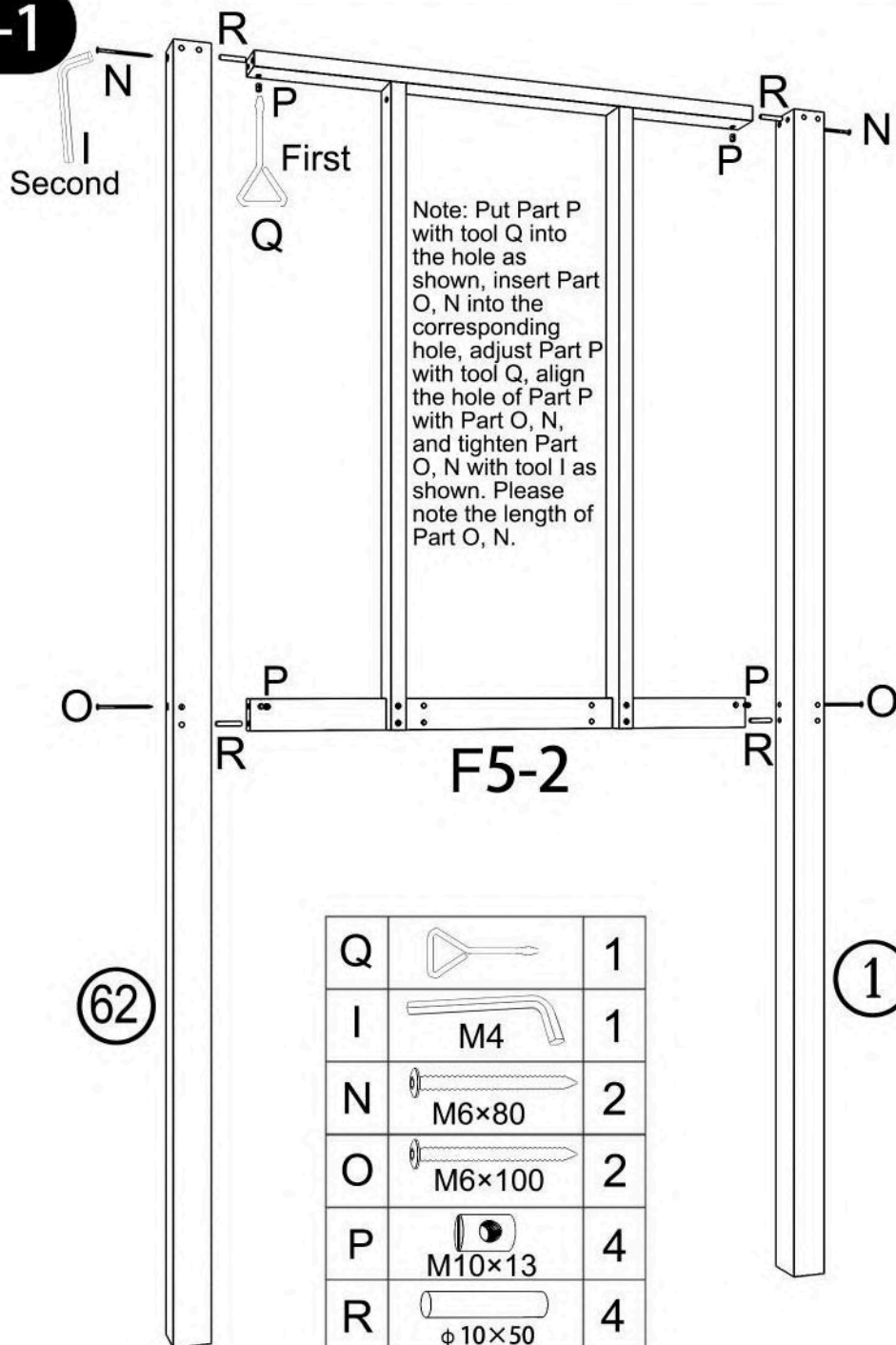

F6-2

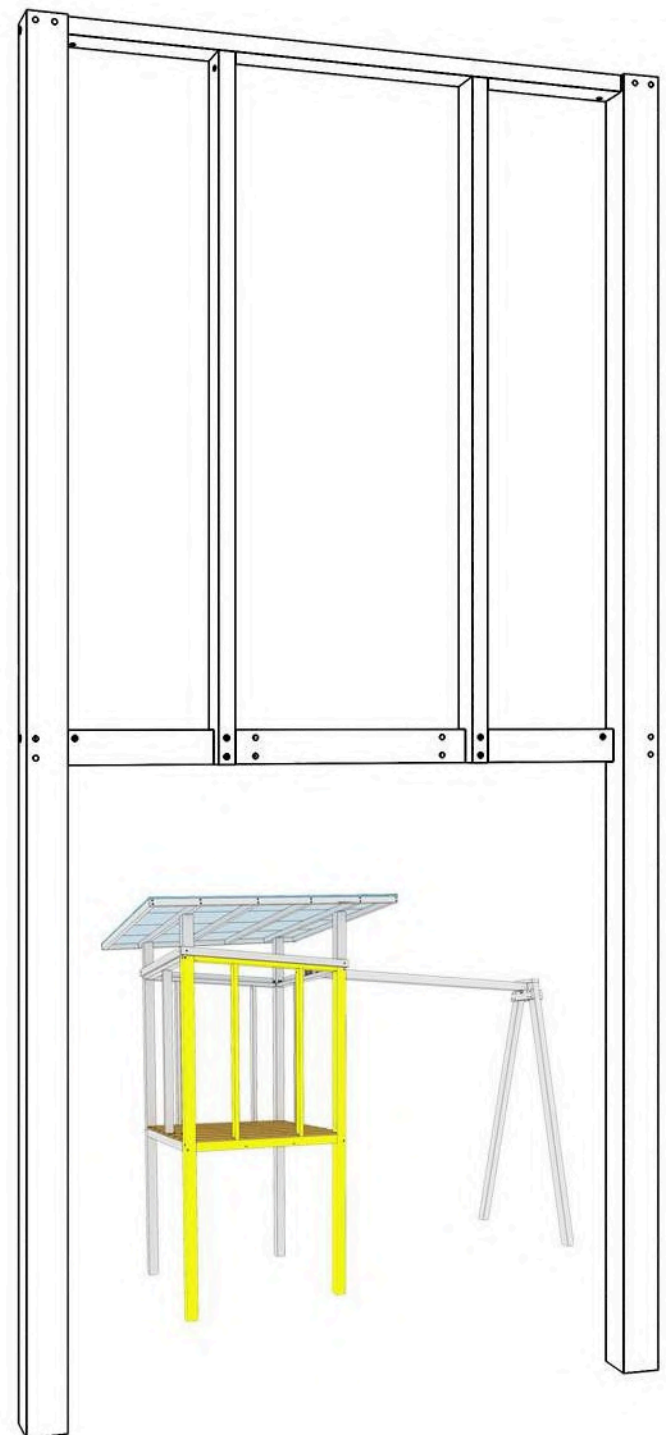

G1-1

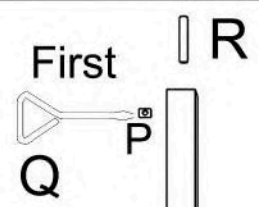

⑧

Note: Put Part P with tool Q into the hole as shown, insert Part M into the corresponding hole, adjust Part P with tool Q, align the hole of Part P with Part M, and tighten Part M with tool I.

④

Q		1
I	M4	1
M	M6×60	1
P	M10×13	1
R	φ10×50	1

G1-2

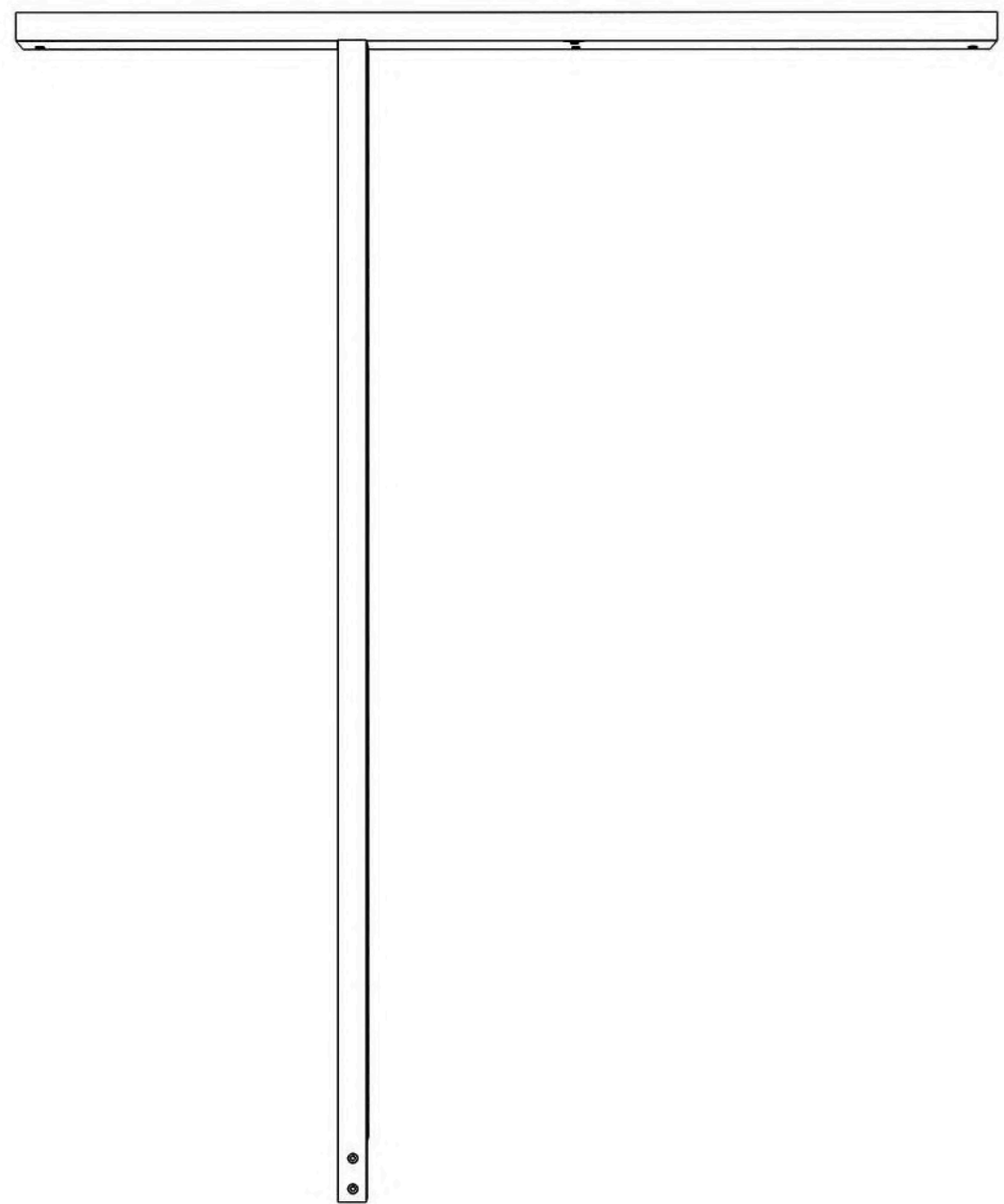

G2-1

G1-2

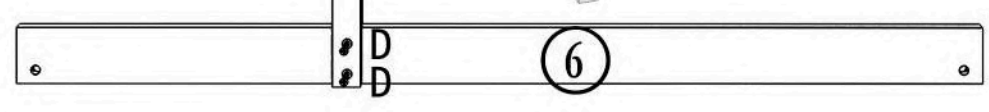

⑥

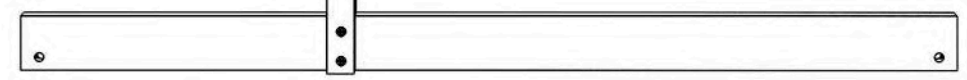

D	M5×50	2
---	-------	---

H1-1

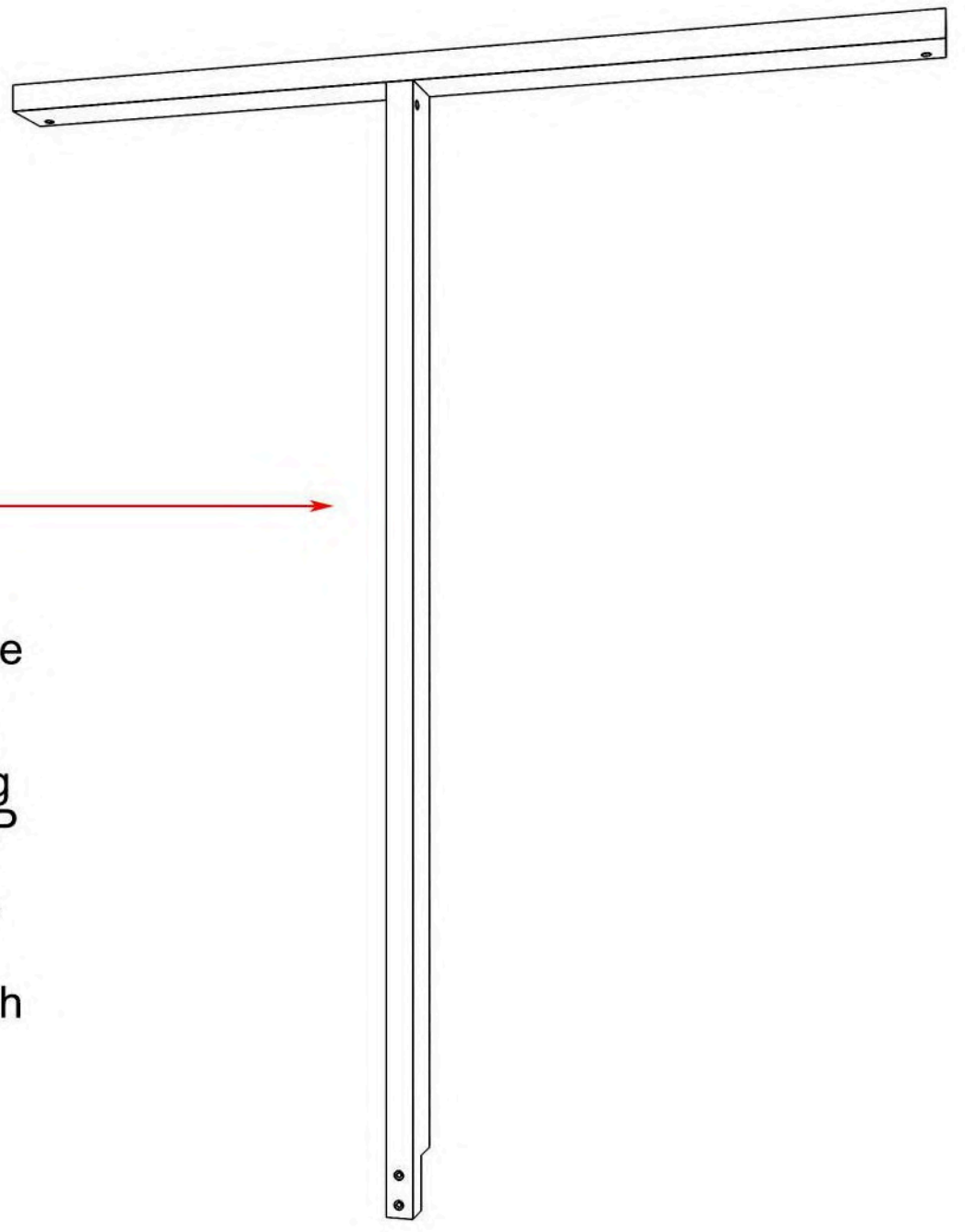
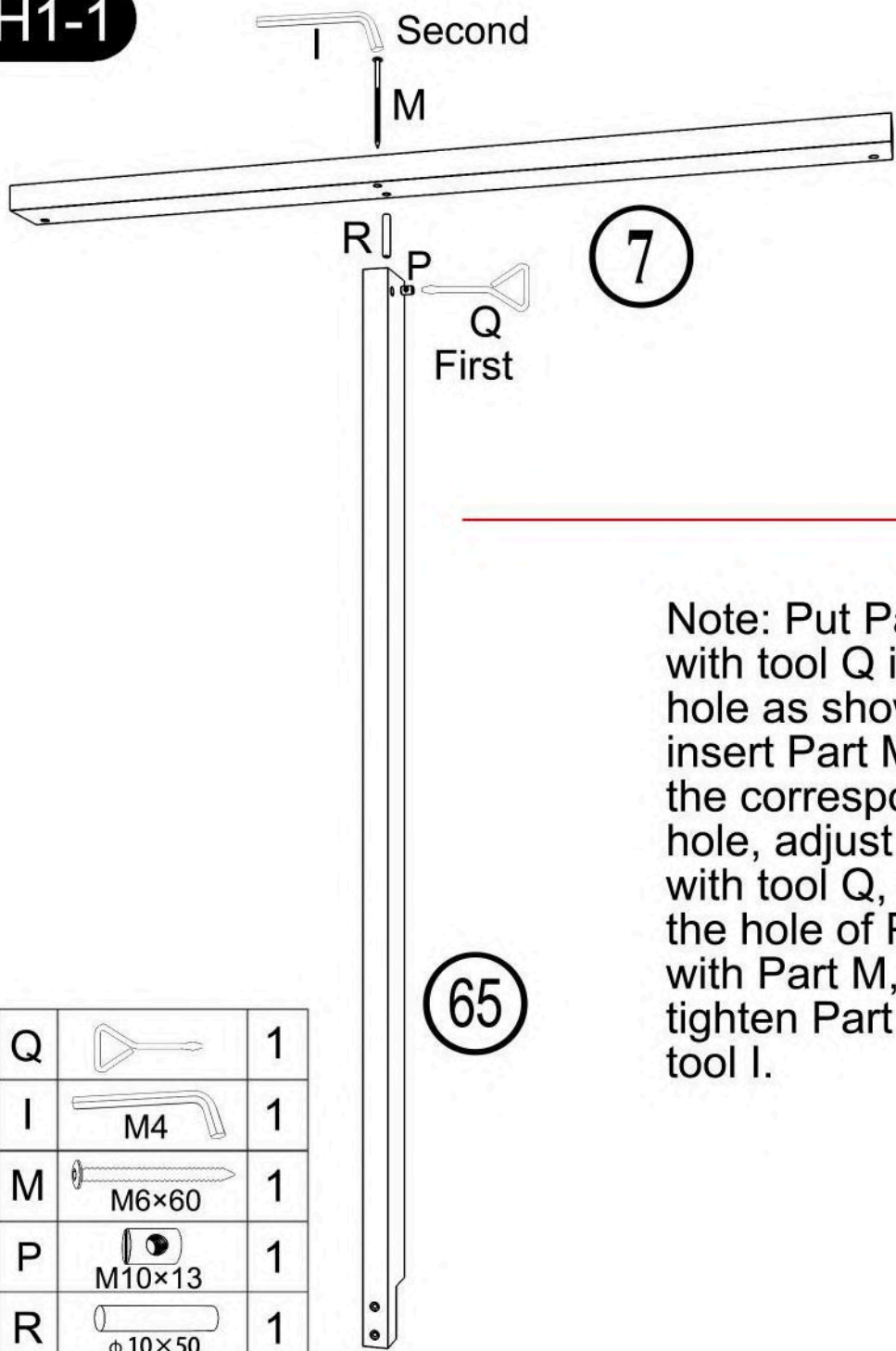

7

65

Note: Put Part P with tool Q into the hole as shown, insert Part M into the corresponding hole, adjust Part P with tool Q, align the hole of Part P with Part M, and tighten Part M with tool I.

Q		1
I		1
M		1
P		1
R		1

H2-1

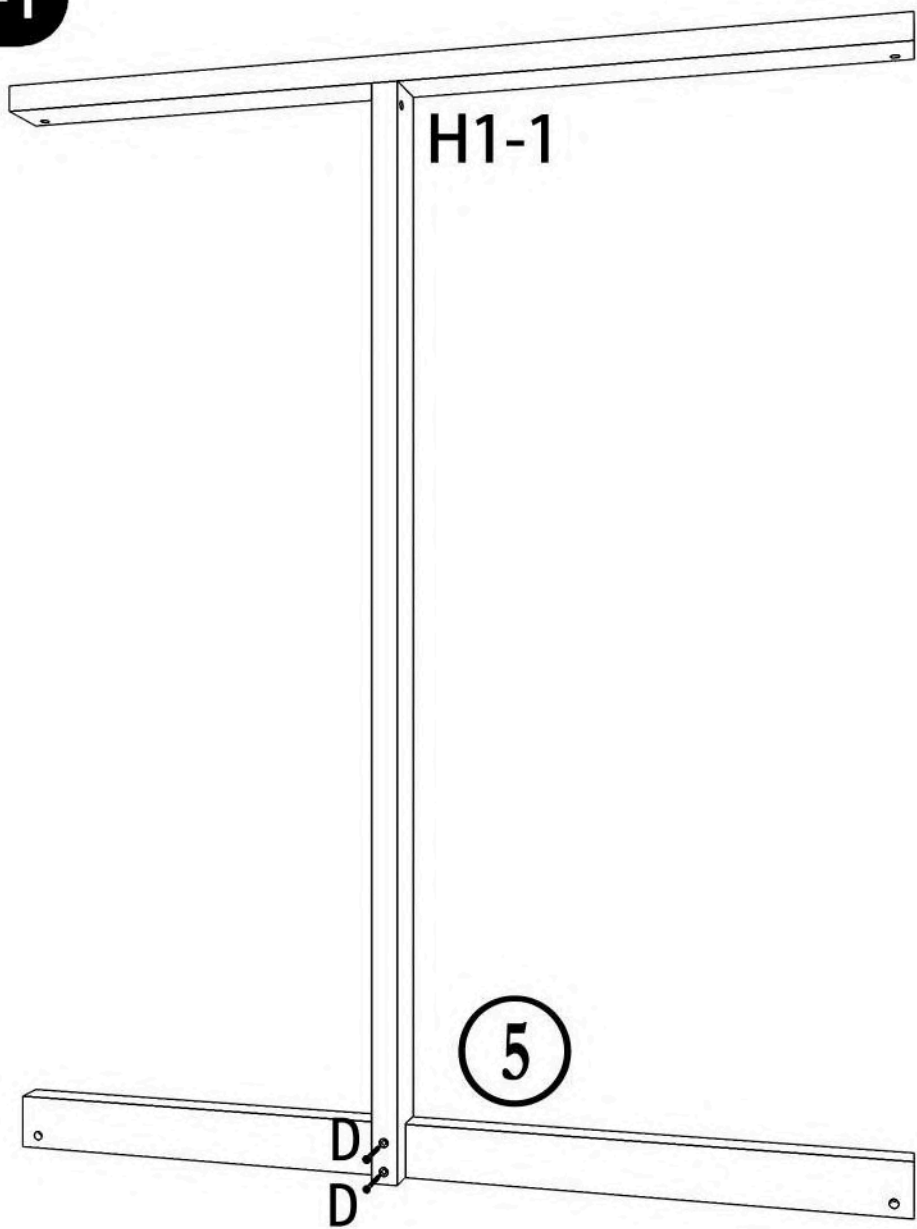

H1-1

5

D		2
---	--	---

H2-2



NOTE: First prepare parts F3-2, H2-2, G2-1, parts 48, then install as shown

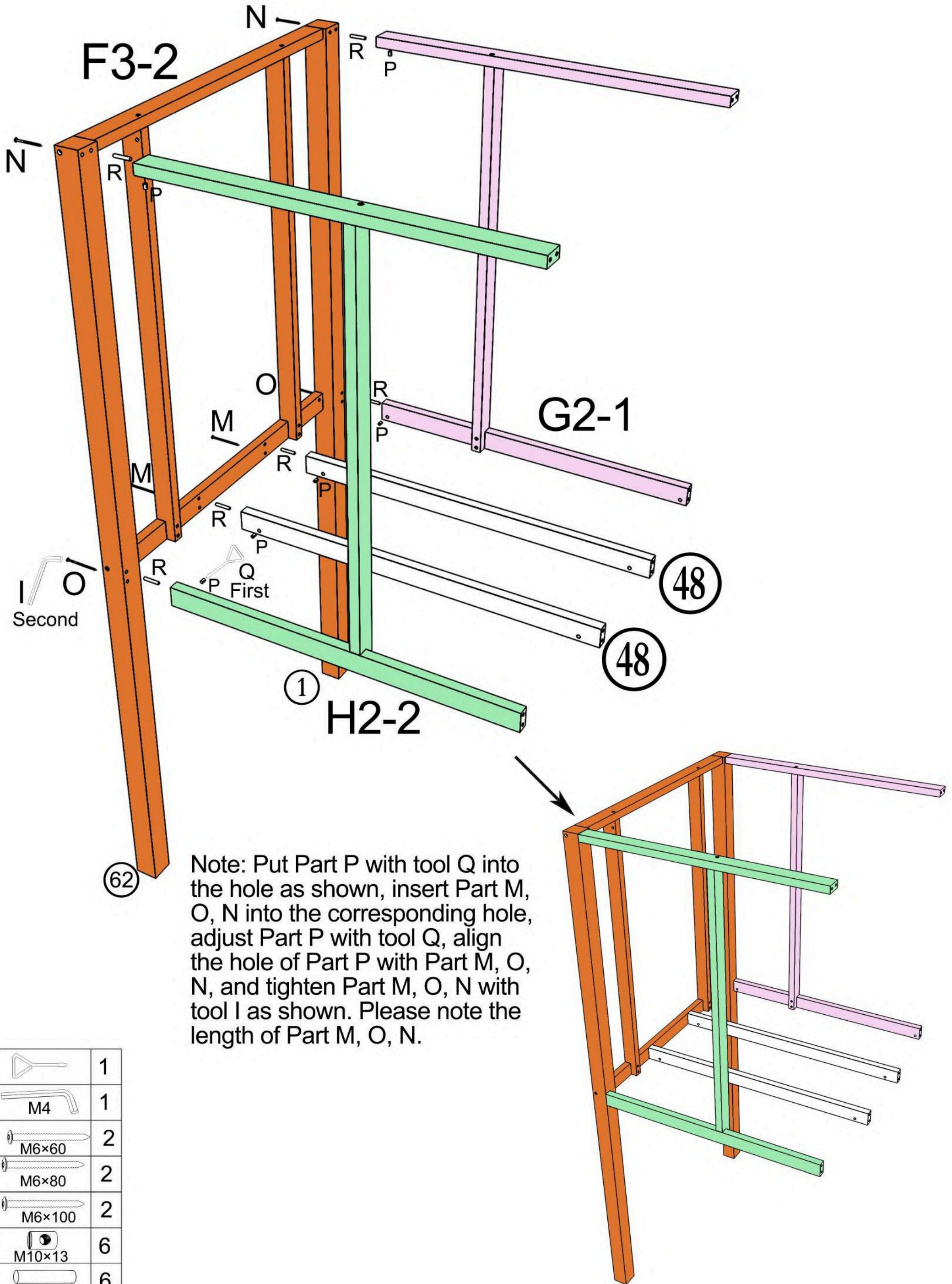

Note: Put Part P with tool Q into the hole as shown, insert Part M, O, N into the corresponding hole, adjust Part P with tool Q, align the hole of Part P with Part M, O, N, and tighten Part M, O, N with tool I as shown. Please note the length of Part M, O, N.

Q		1
I		1
M		2
N		2
O		2
P		6
R		6

I2-1

NOTE: First prepare parts I1-1, F6-1, then install as shown

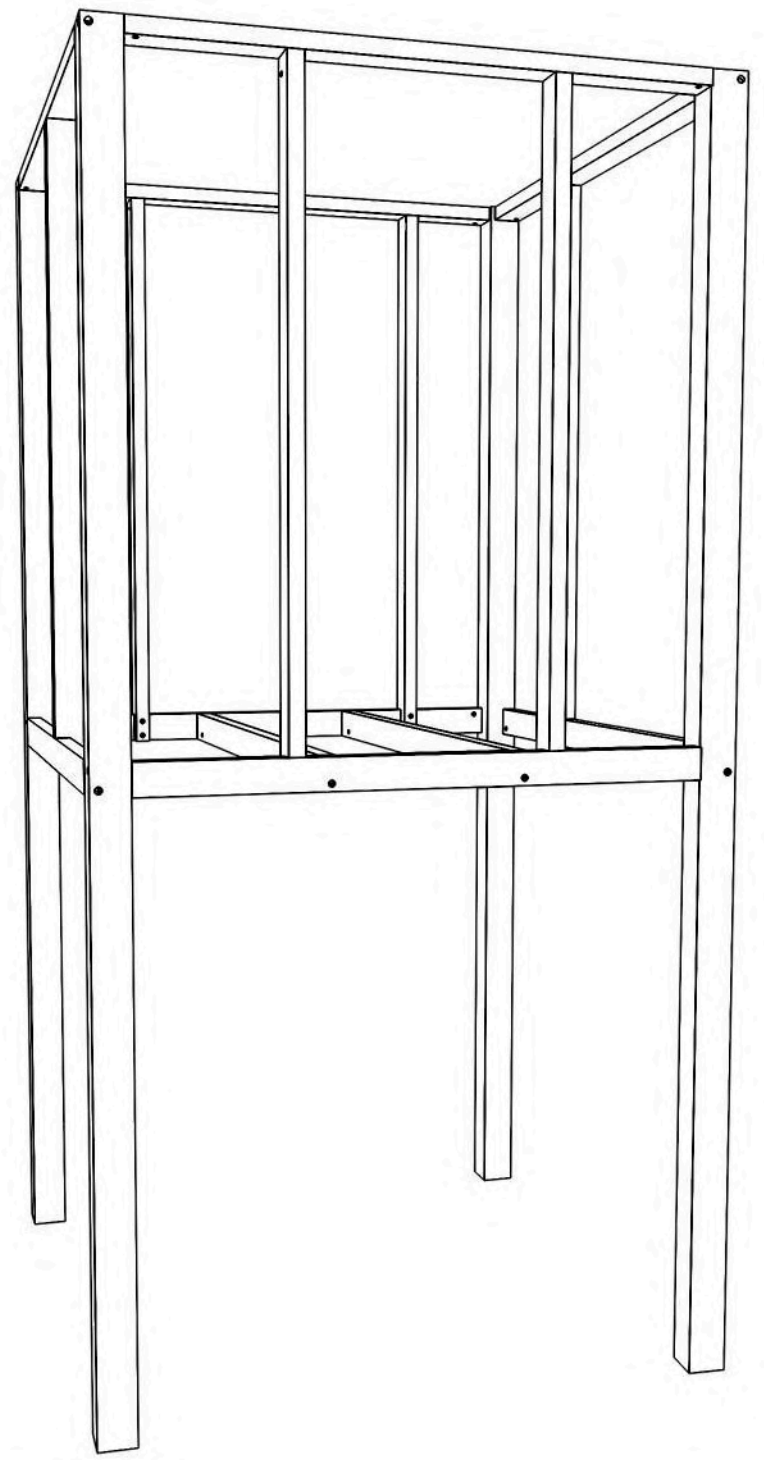
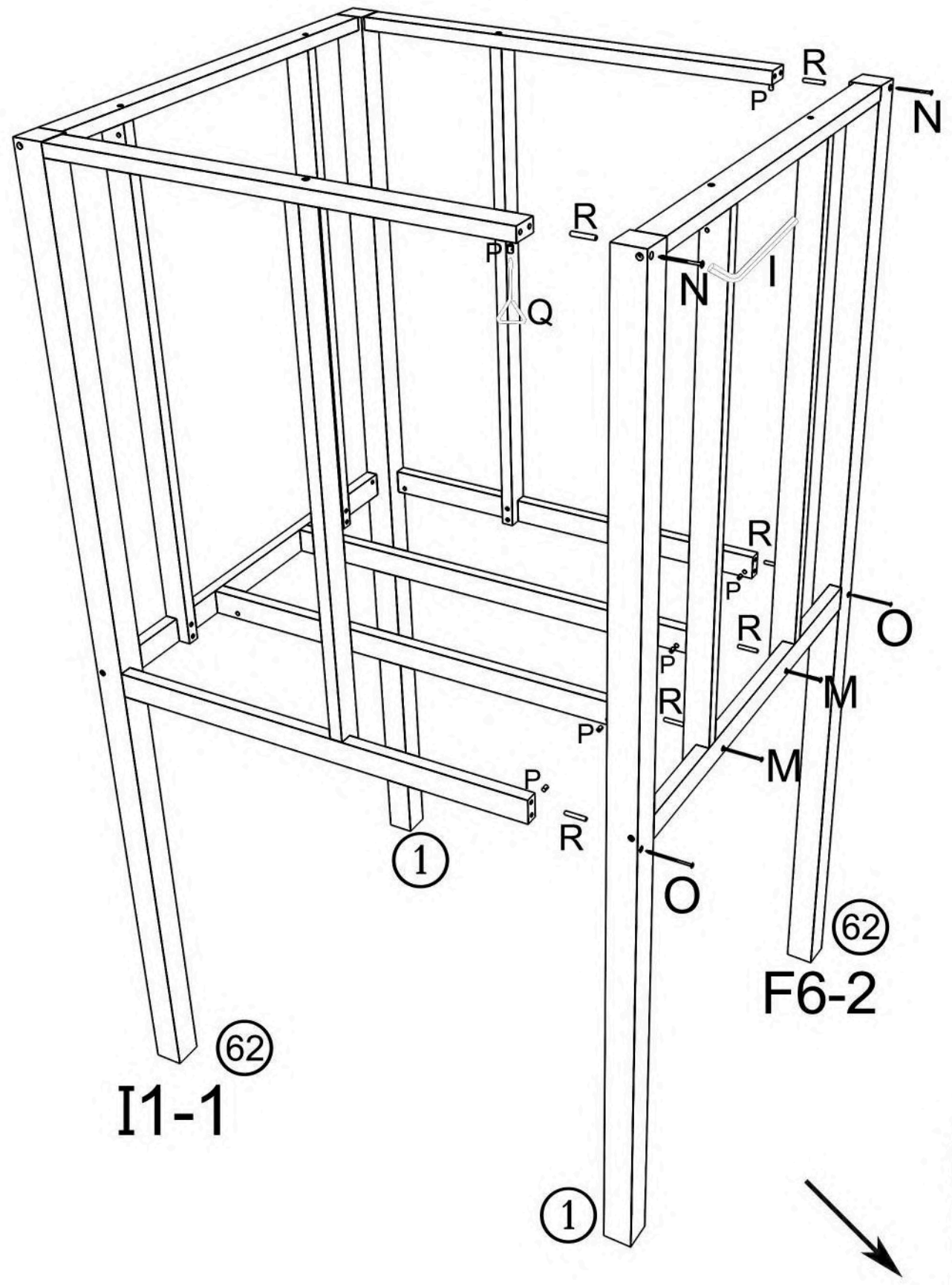

Q		1
I		1
M		2
N		2
O		2
P		6
R		6

Four-sided positioning

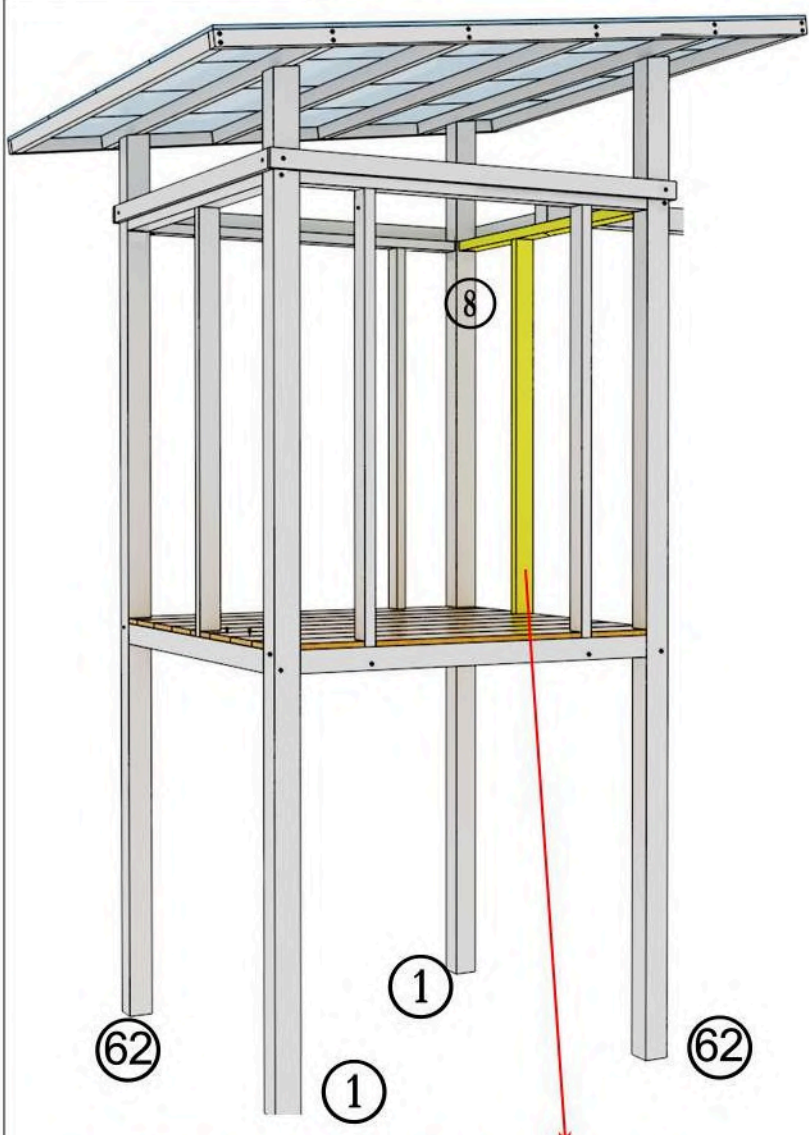

NOTE: Define G2-1 as side V

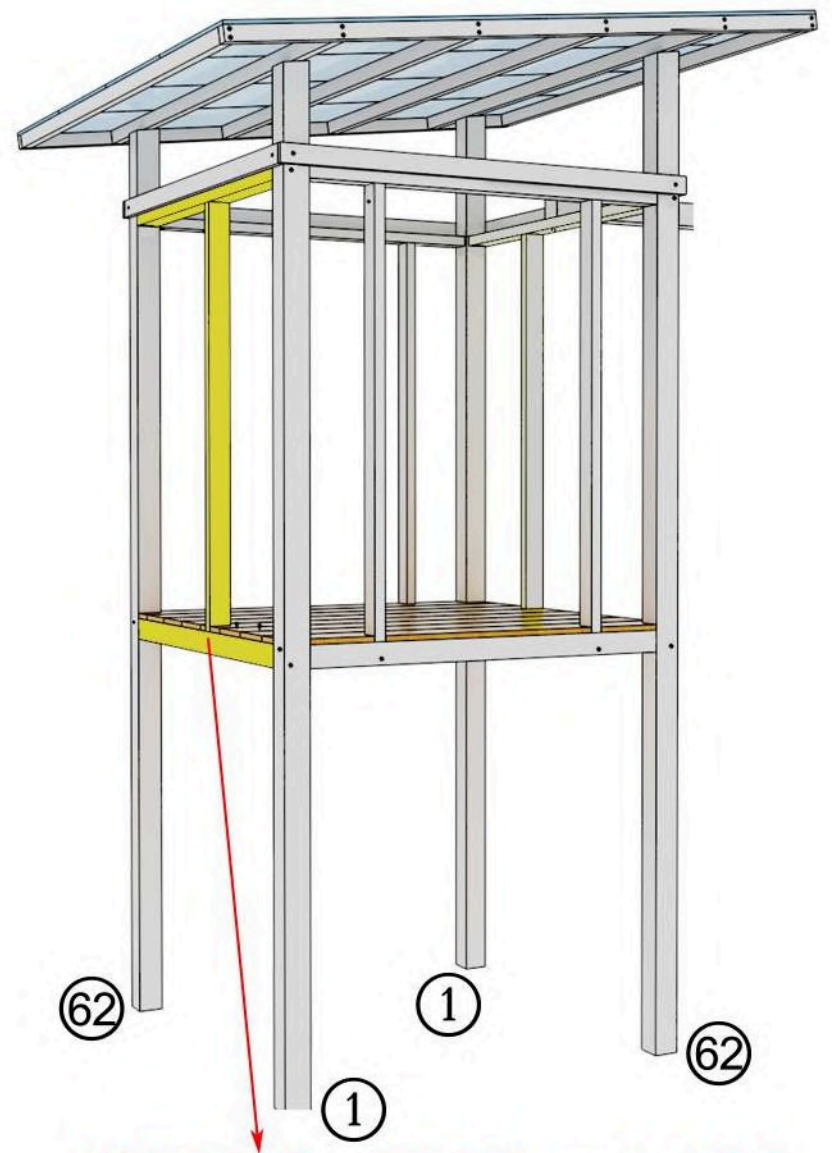

NOTE: Define G2-1 Opposite H2-2 as side W

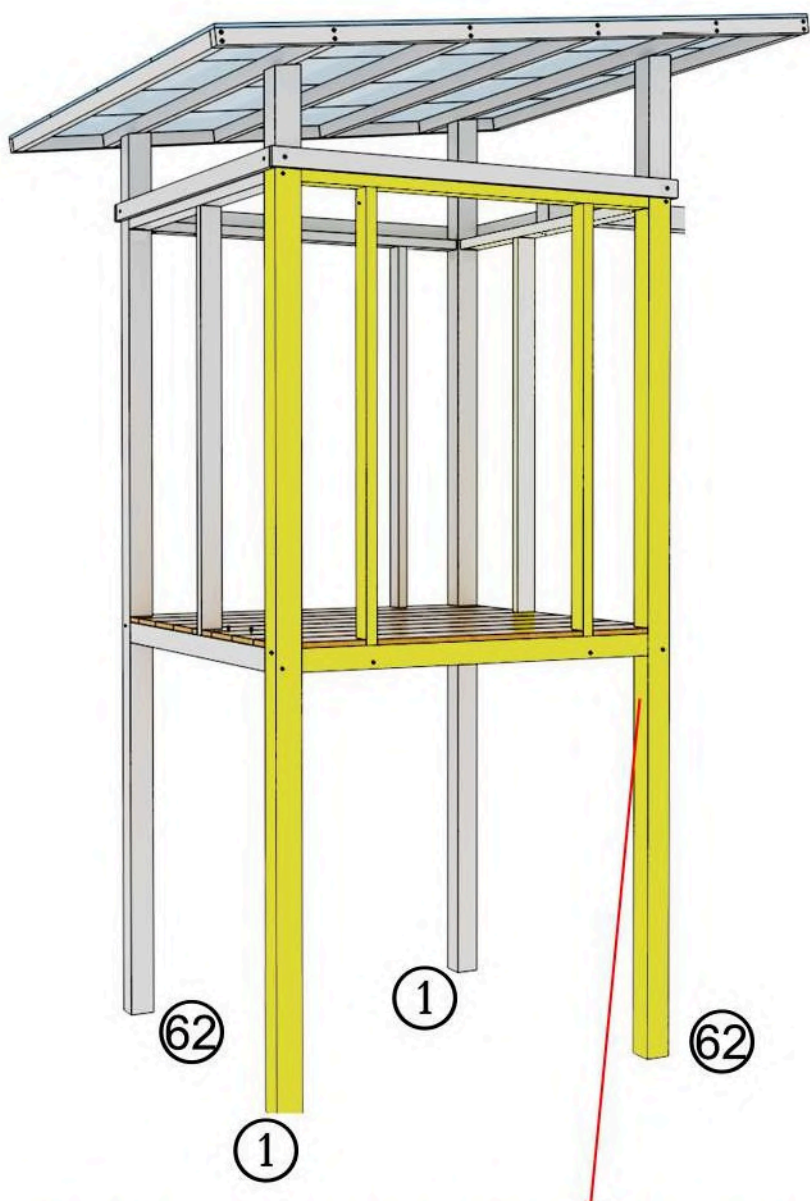

NOTE: Facing side V, define the left side as side Y

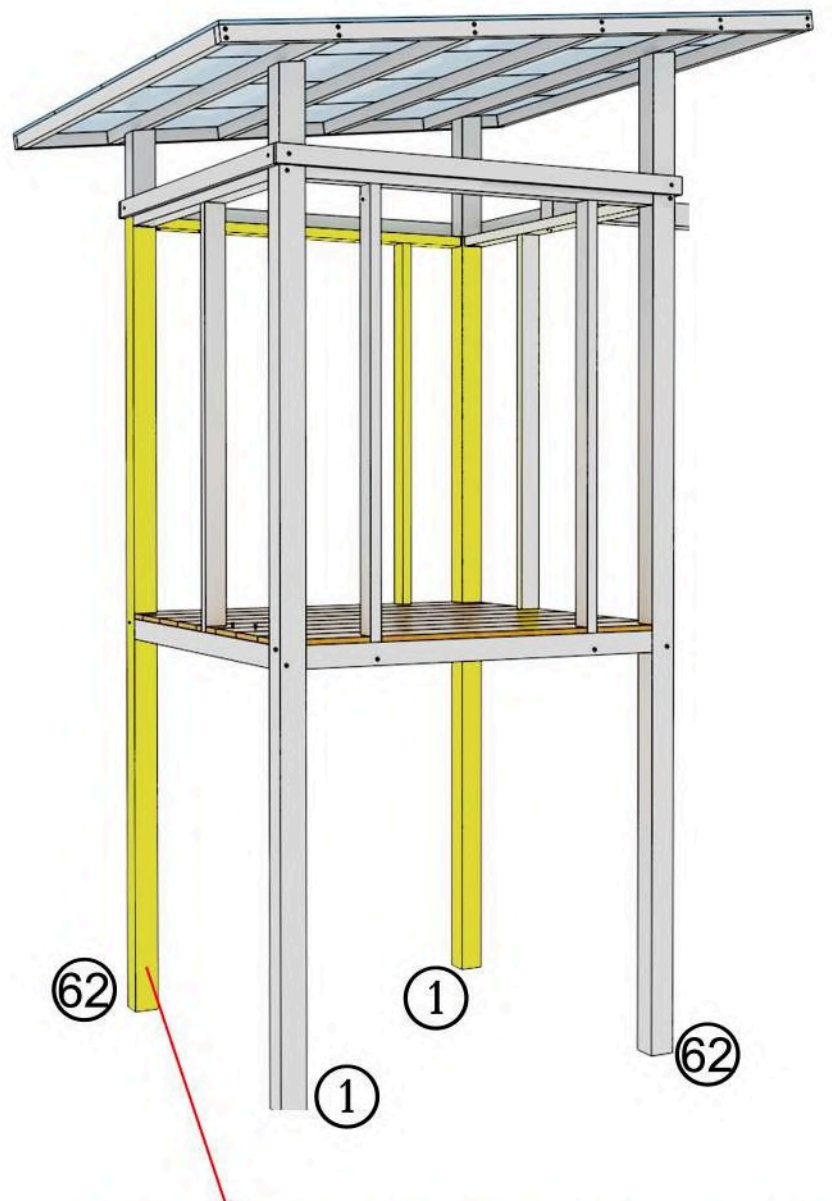

NOTE: Facing side V, define the right side as side Z

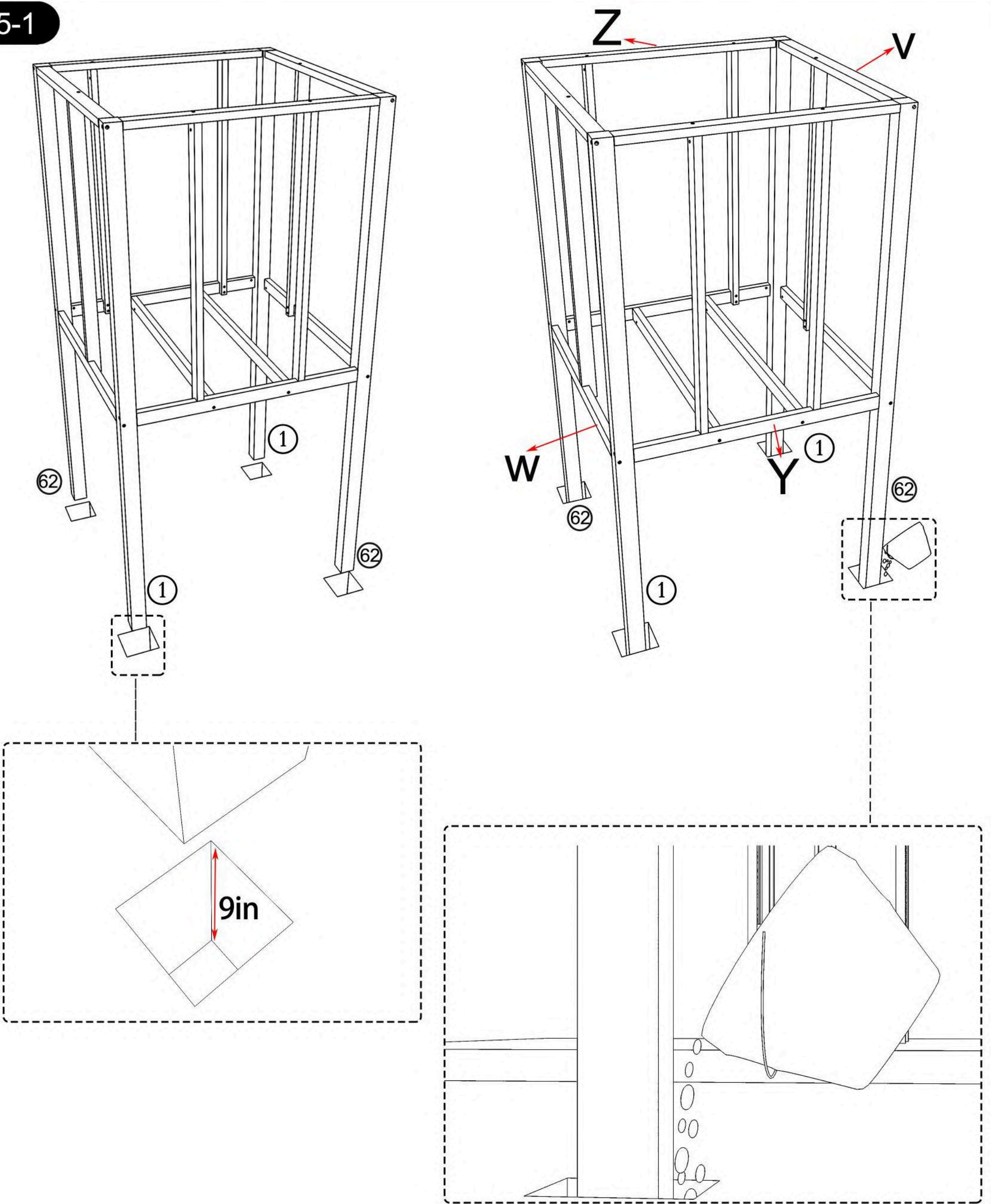

NOTE: Side V is the part A5-2 side to be installed, insert ground stake into ground by 9 inches, and then pour the cement as shown

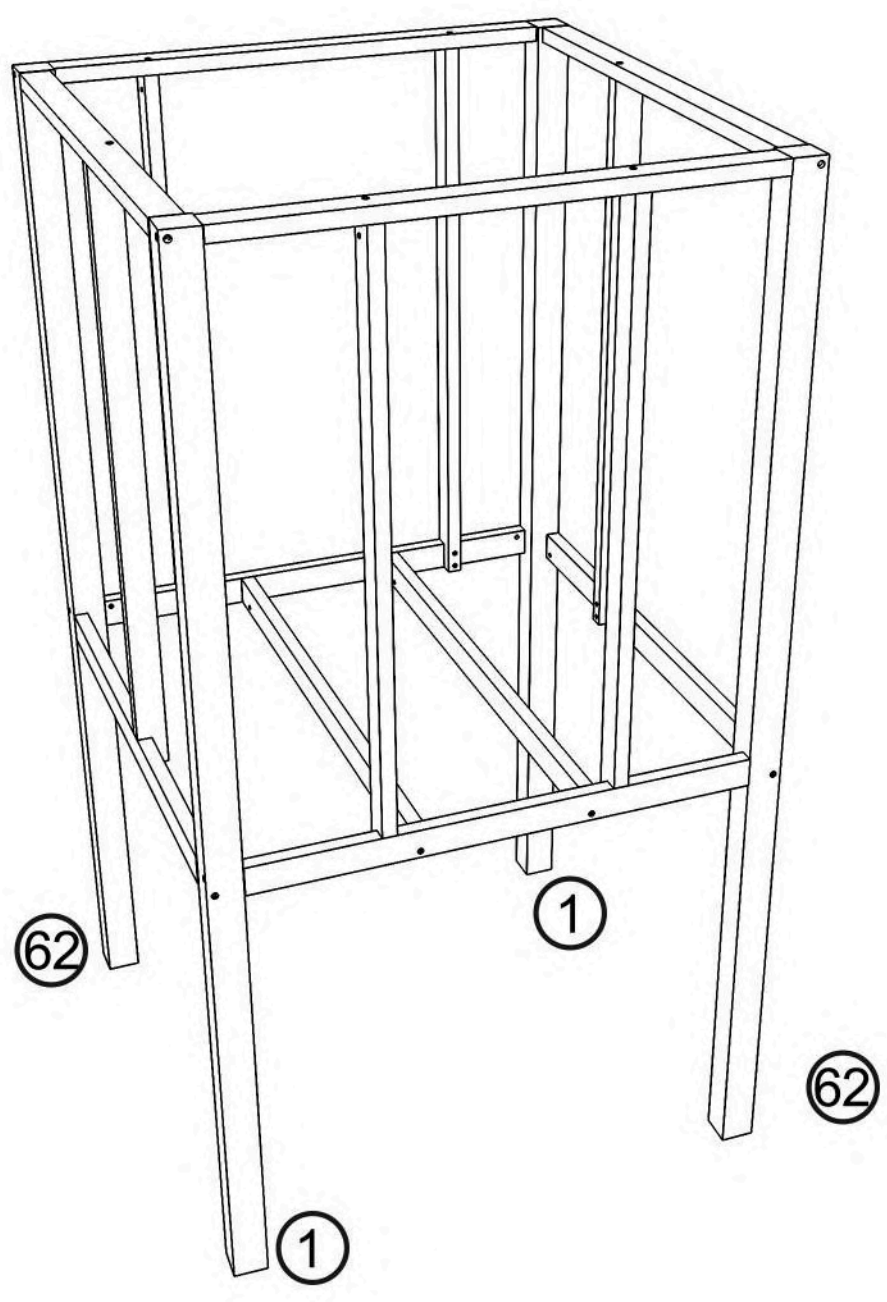

I6-1

NOTE: Start from side Y, put parts 59, 15,15, 17, 15, 16, 15, 14 respectively

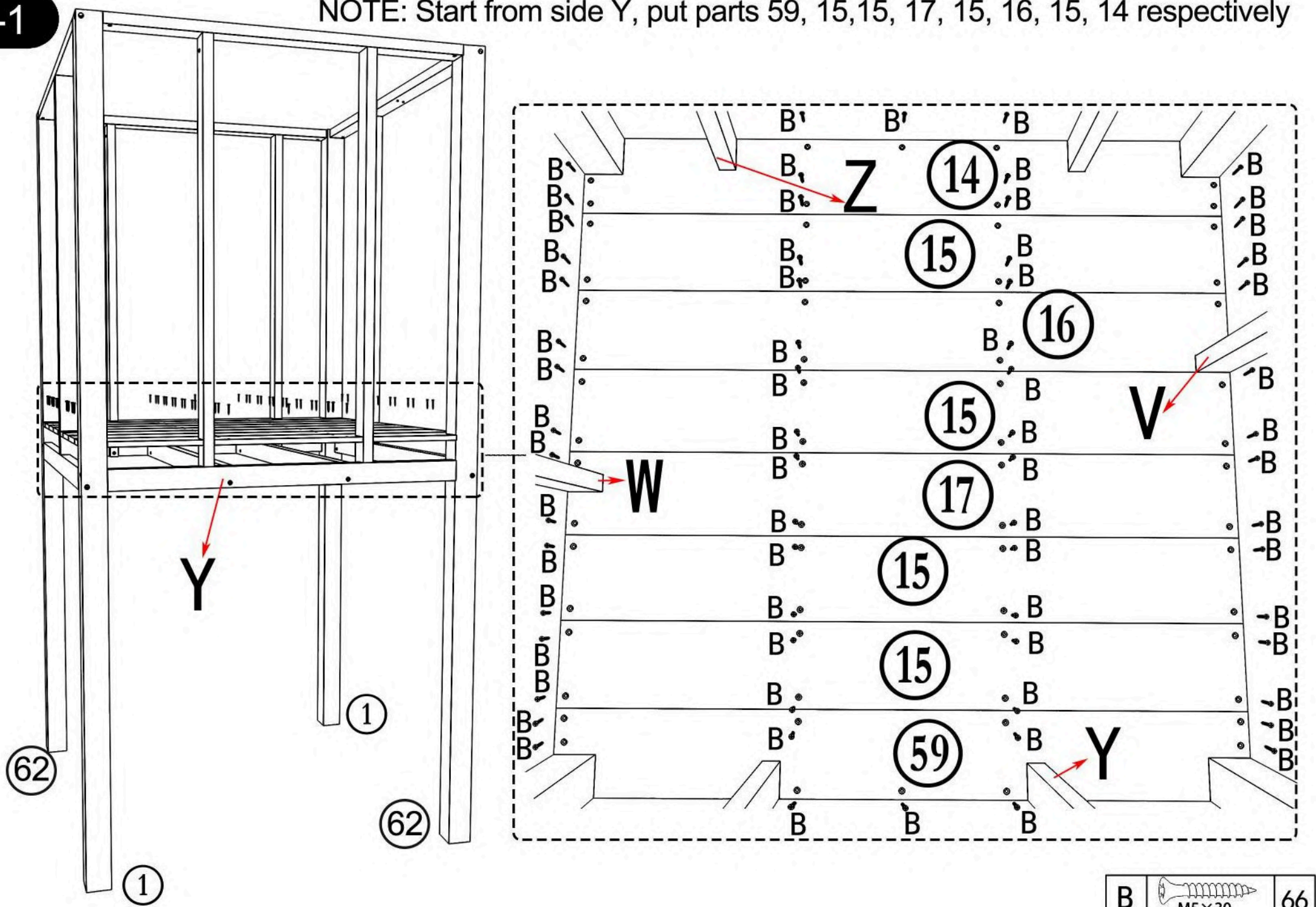

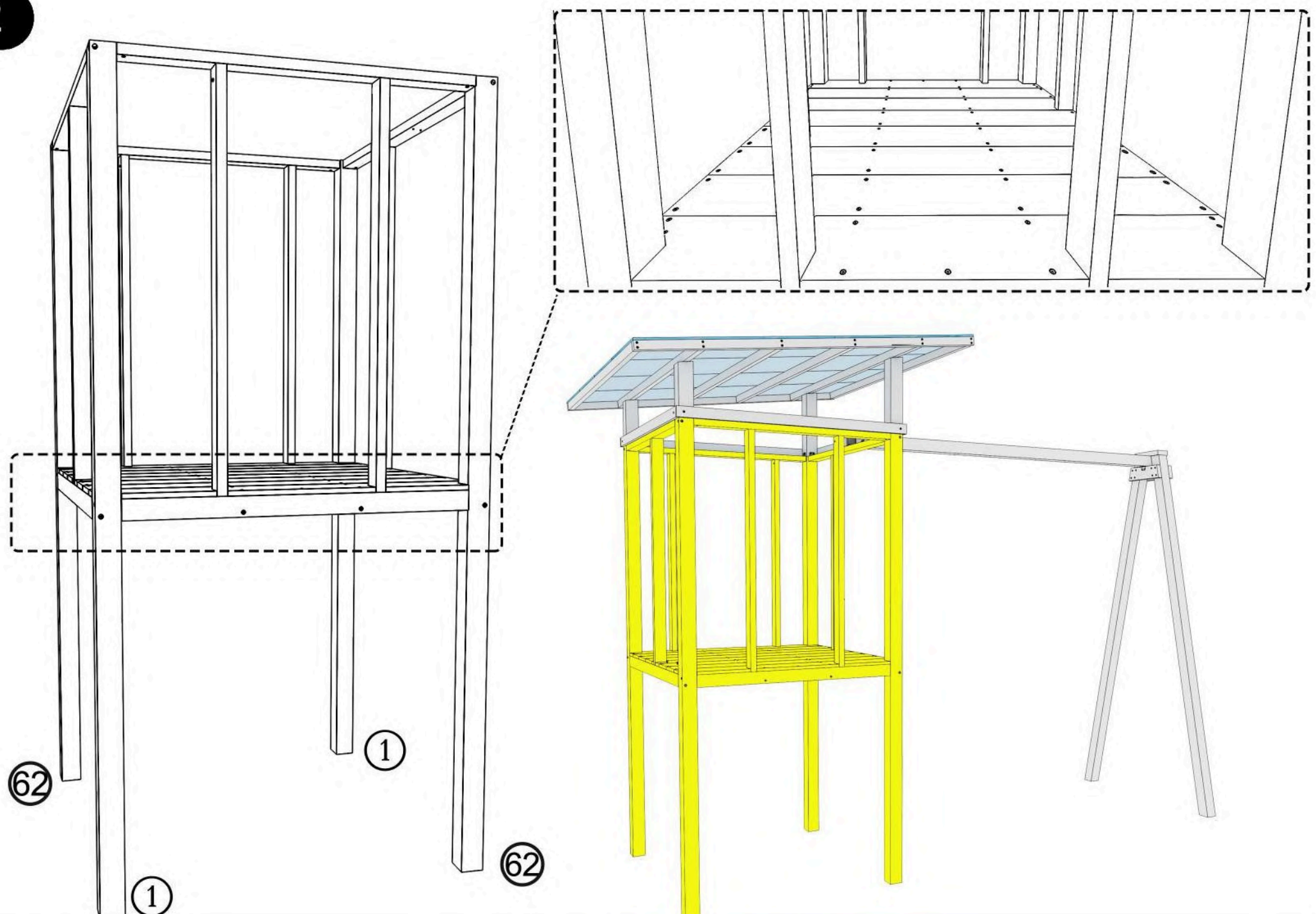

I6-2

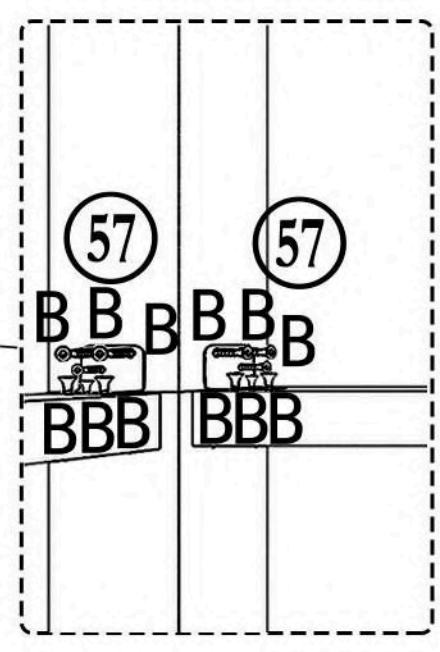
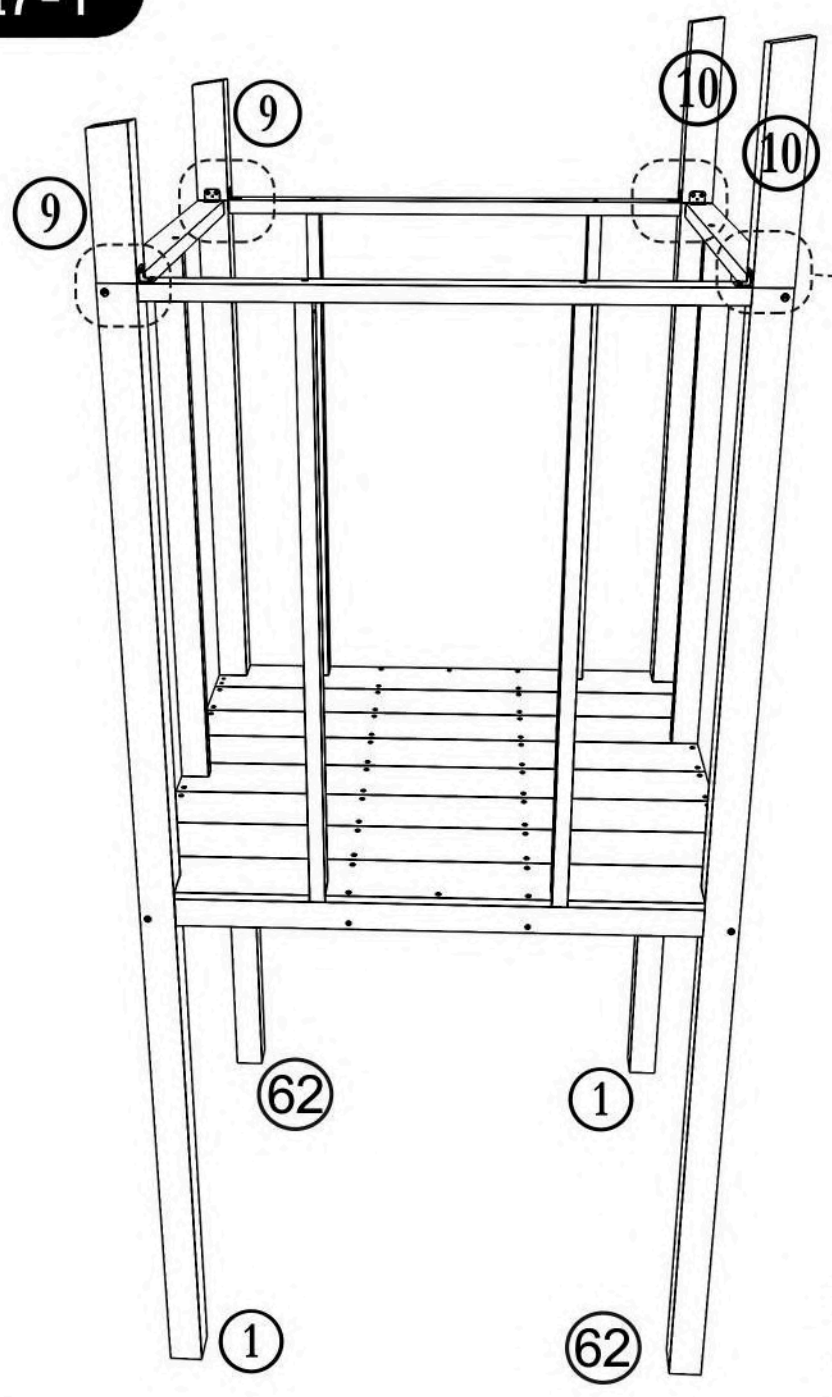

I7-1



NOTE: As shown, parts 10 place on side V, and parts 9 place on side W. Parts 9 & 10 is inclined toward the side W when installed.

(57)		8
B	 M5x30	48

I7-2

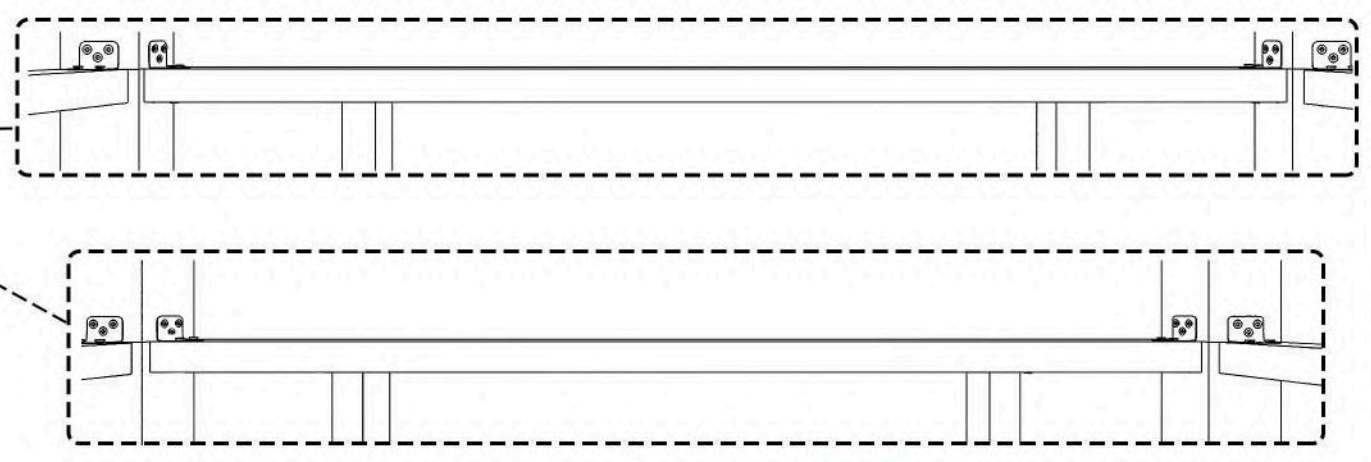
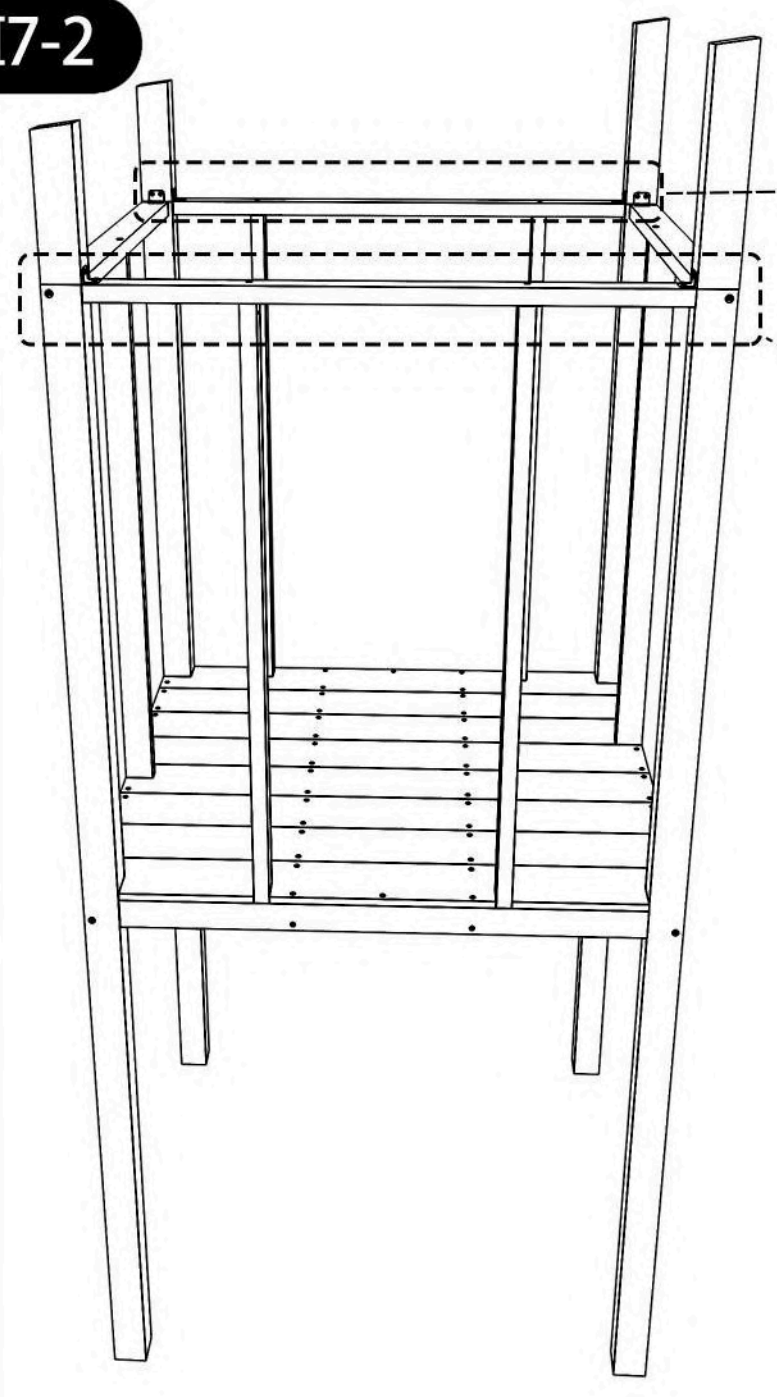

I8-1

NOTE: Use screws B to install parts 64, 19, 22, 23, 43, 28, 29, 67 on side W as shown

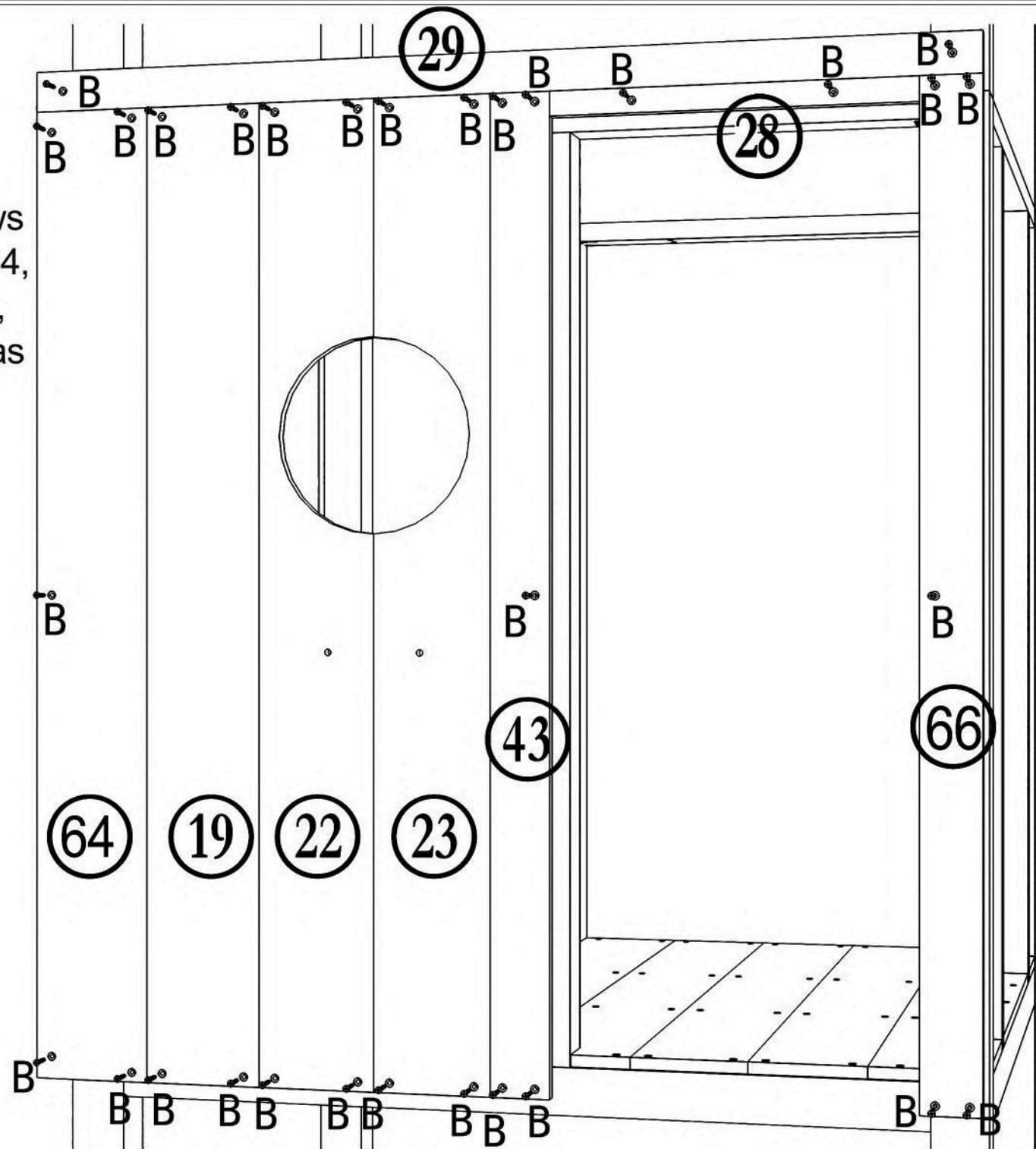

I8-2

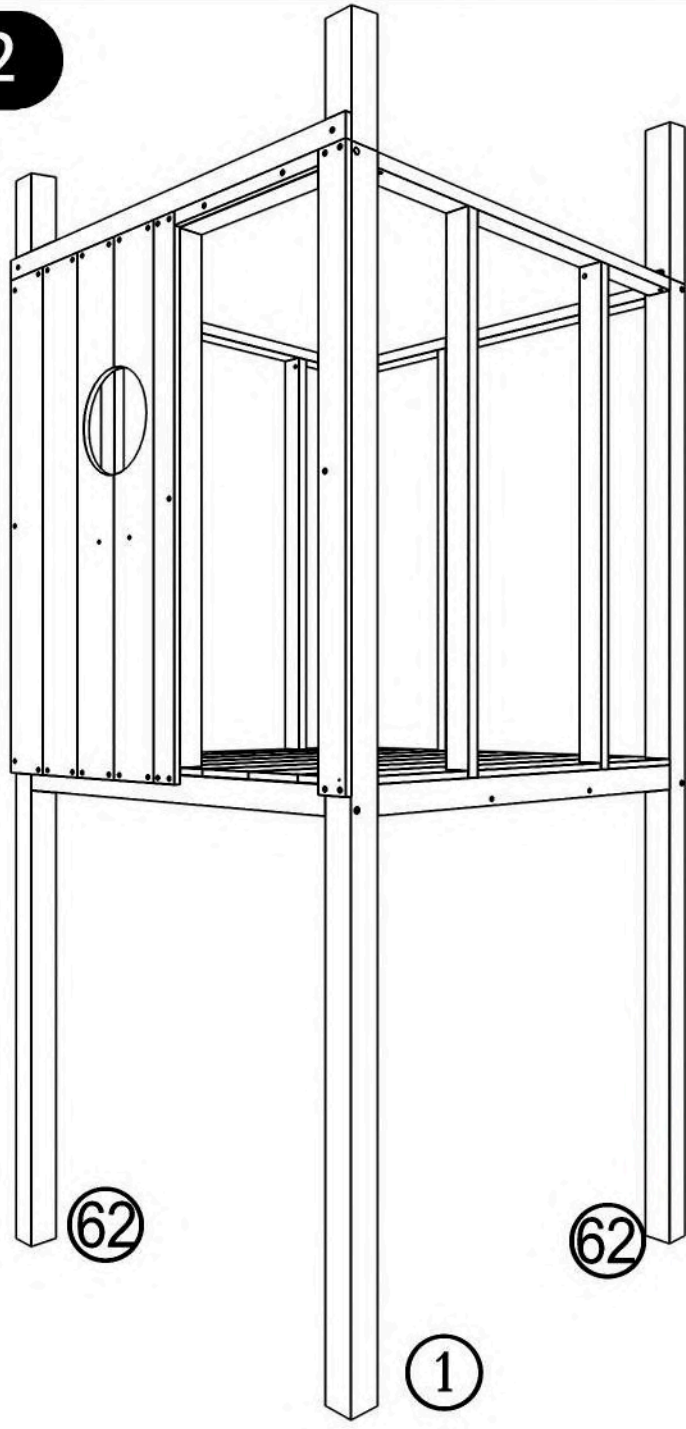

I9-1

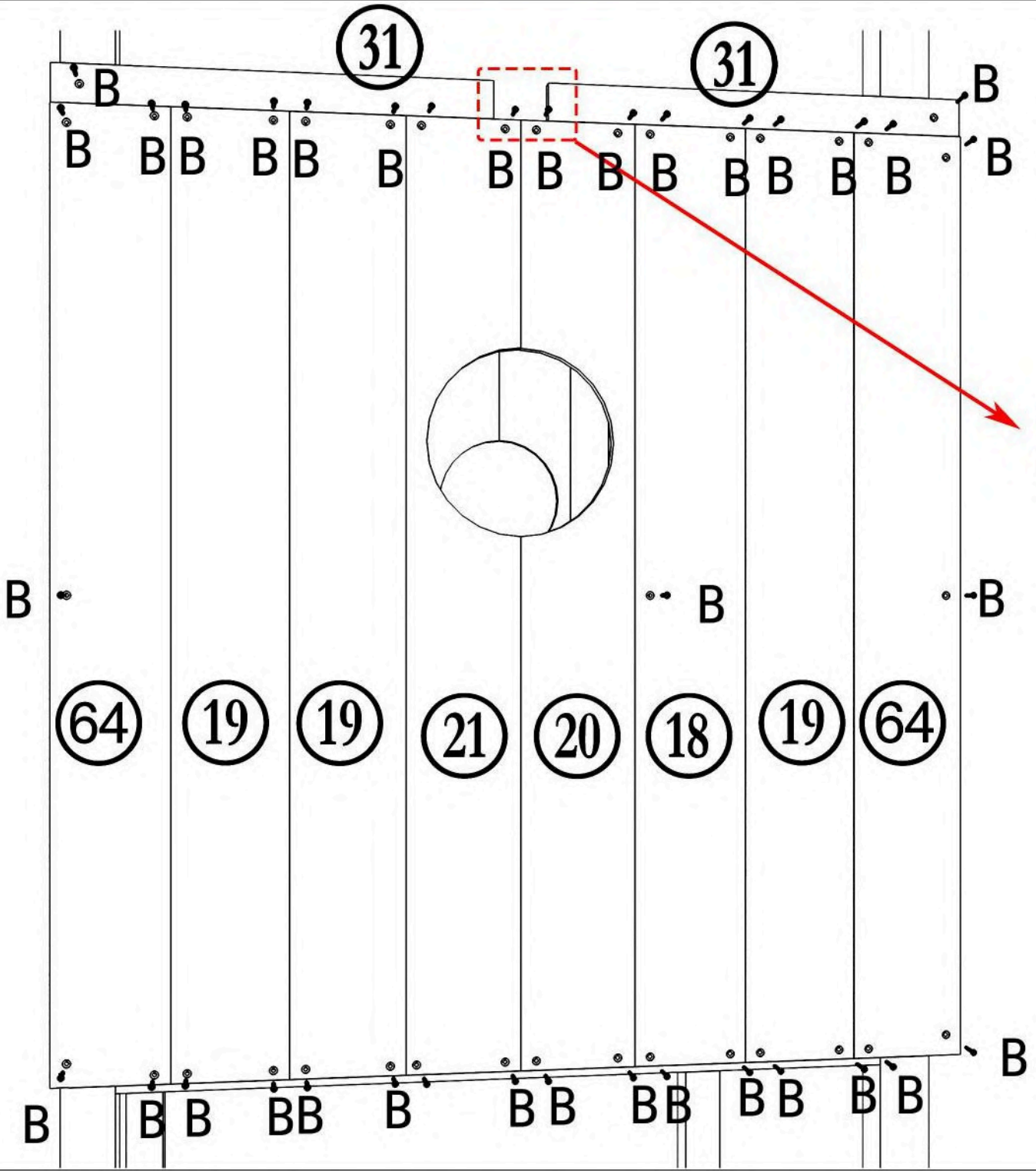

NOTE: Use screws B to install parts 64, 18, 19, 20, 21, 31 on side V as shown

Ensure that 2.76in space is left for this gap

B		37
M5x30		

I9-2

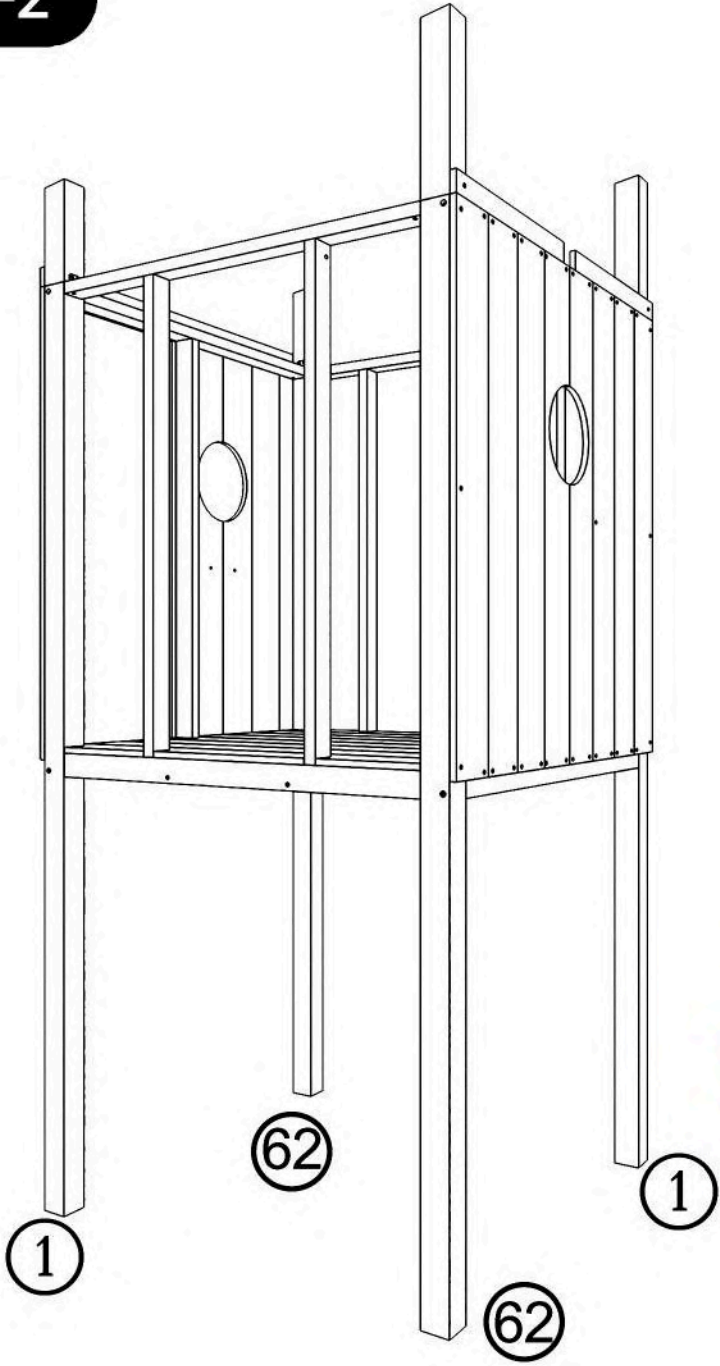

I10-1

NOTE: Use screws B to install parts 24, 25, 26, 27, 30 on side Y as shown

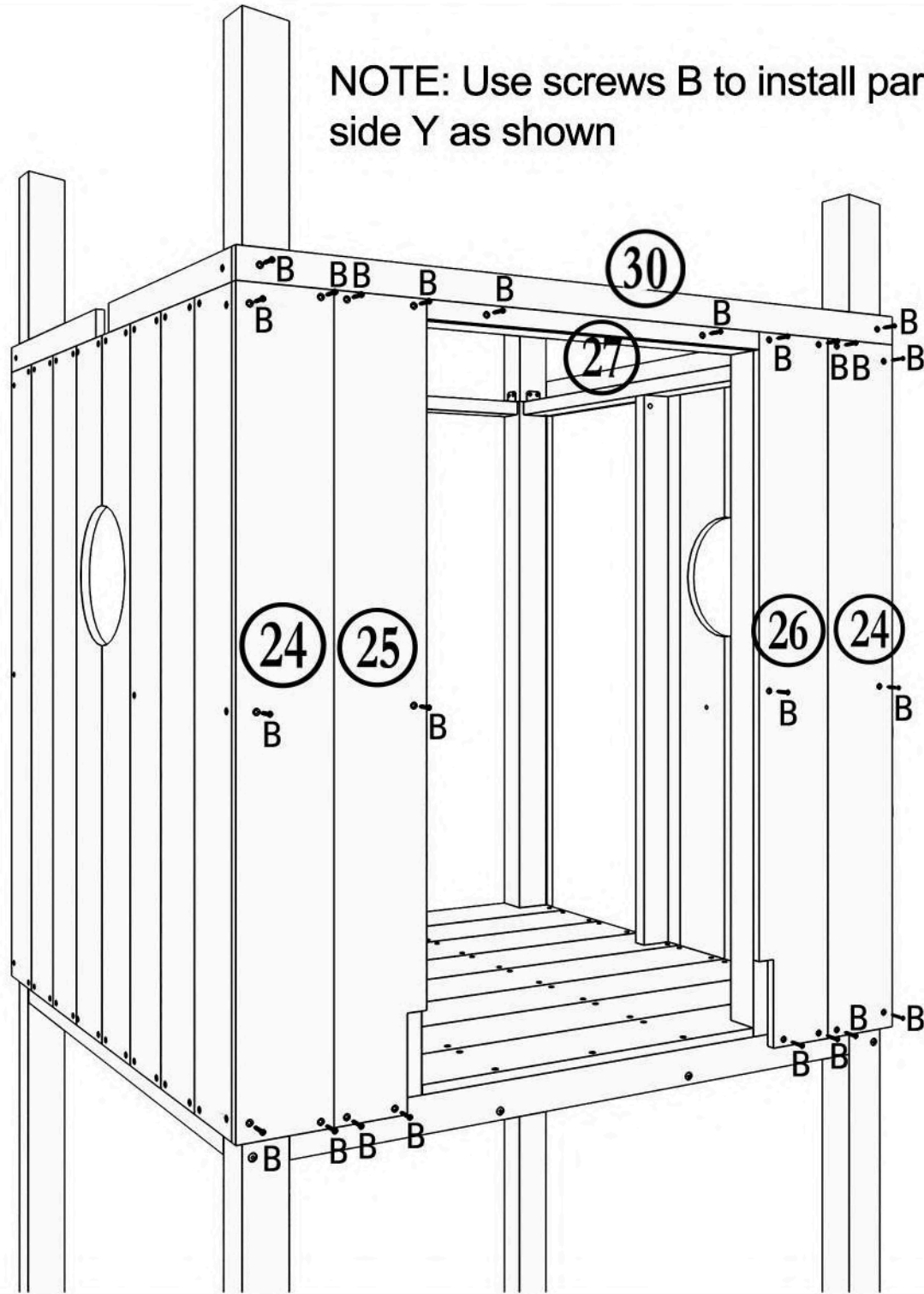

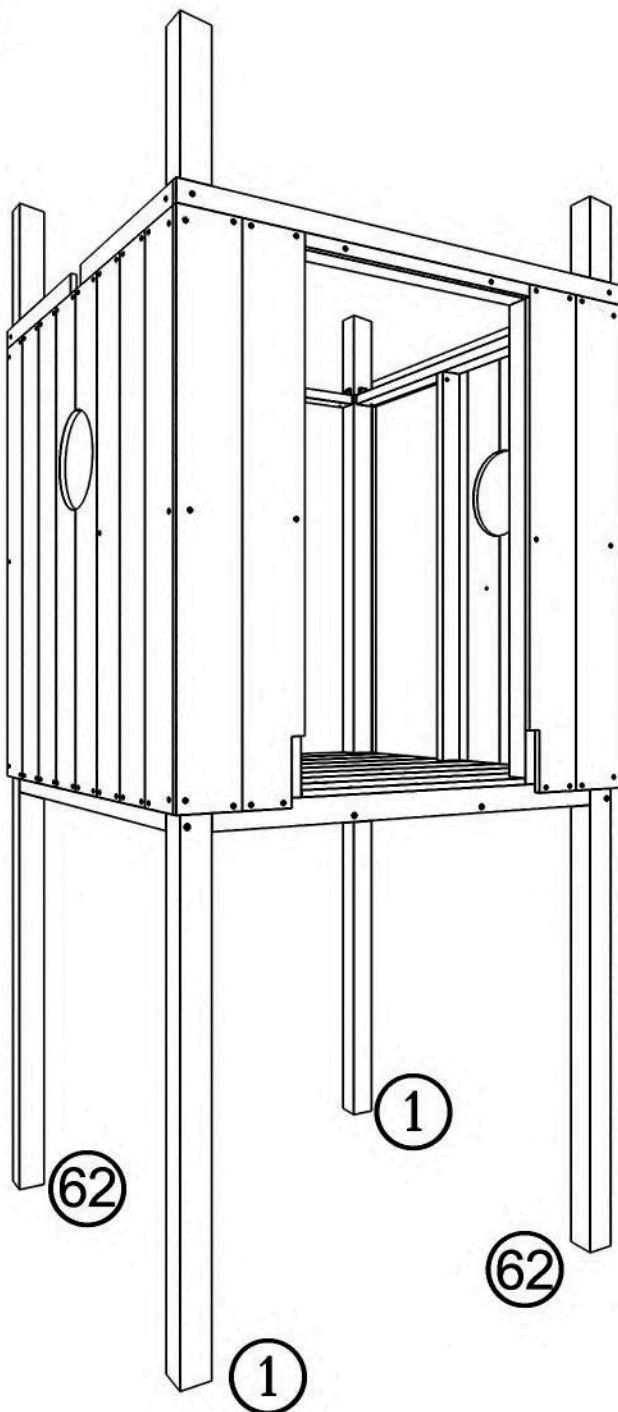

I10-2

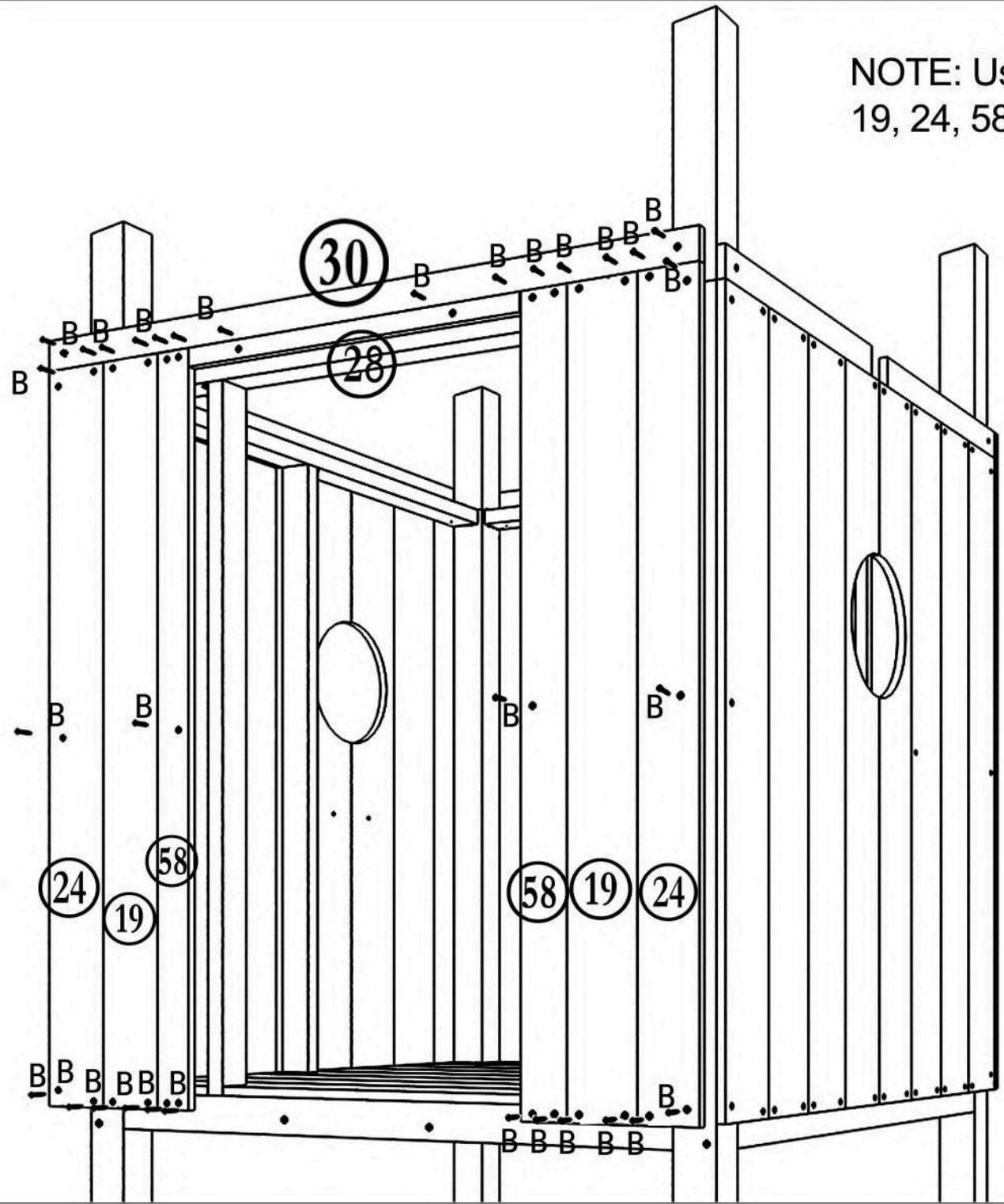

I11-1

NOTE: Use screws B to install parts 19, 24, 58, 28, 30 on side Z as shown



B	 M5x30	32
---	--	----

I11-2

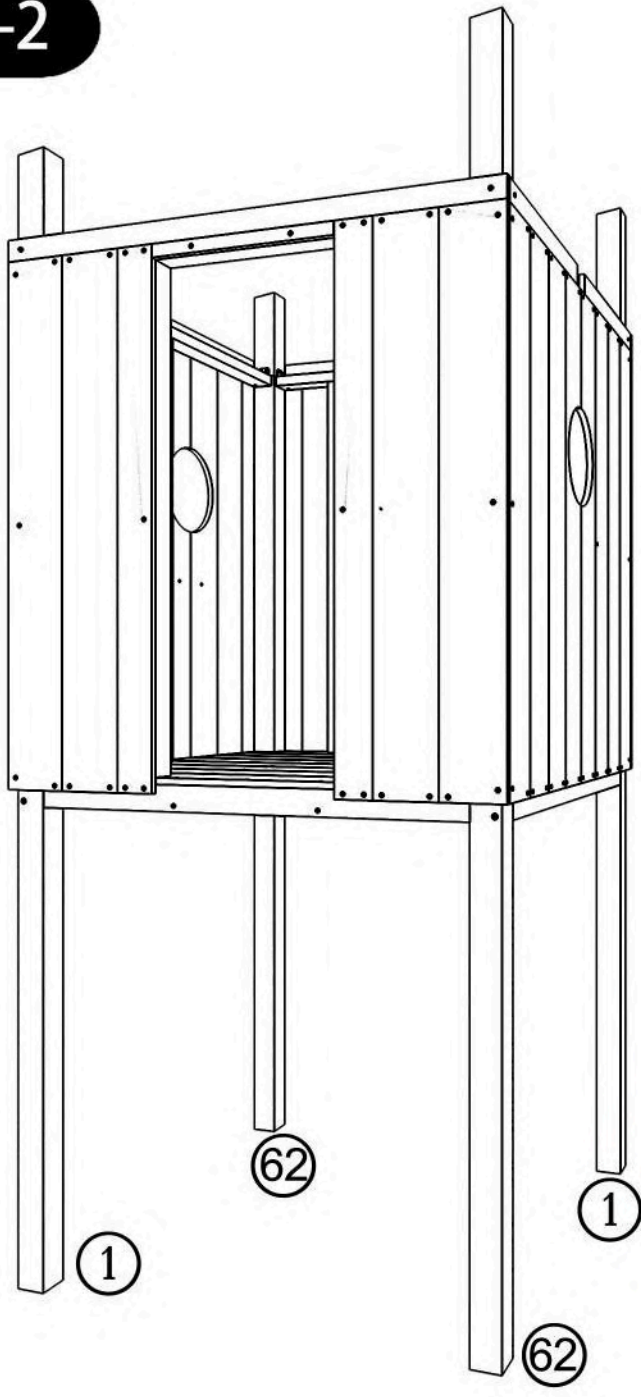

J-1

NOTE: Use screws H to install part D1-1 on side W

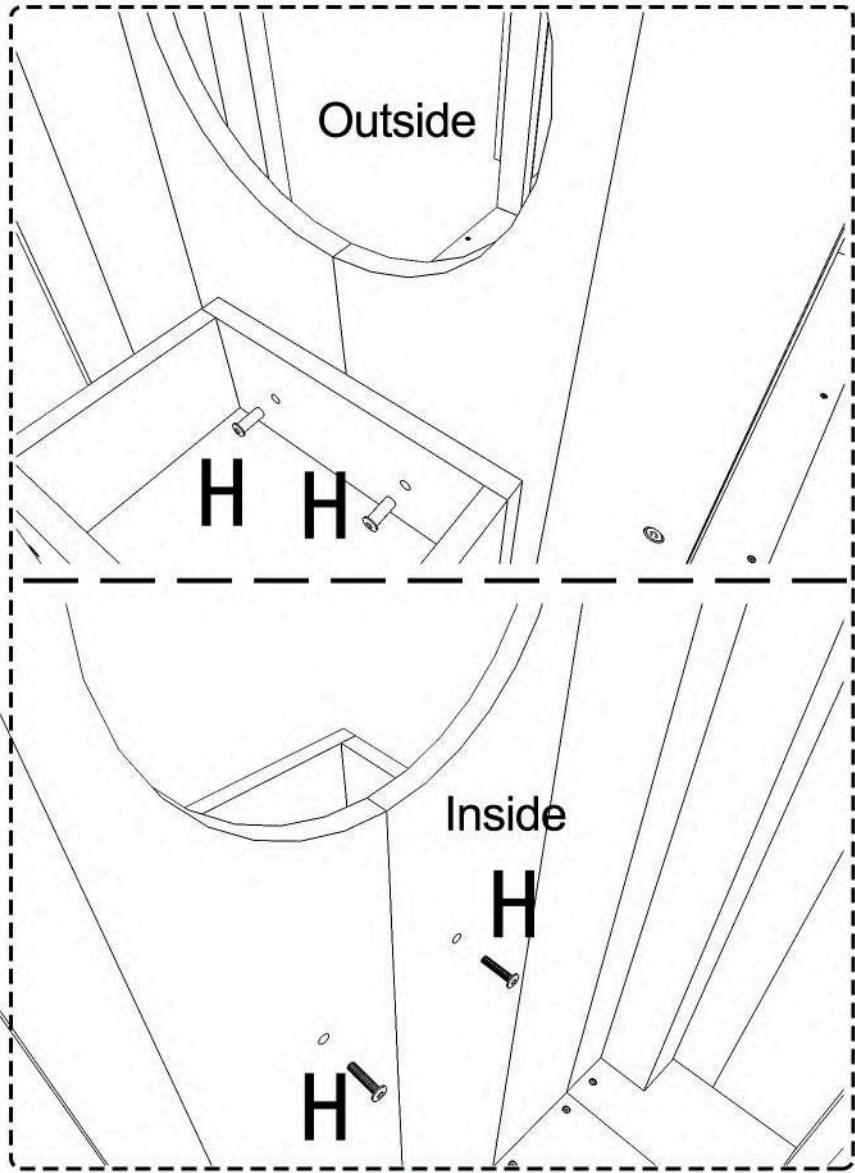

D1-1

62

1

62

1

H M6×20 M6×15 2

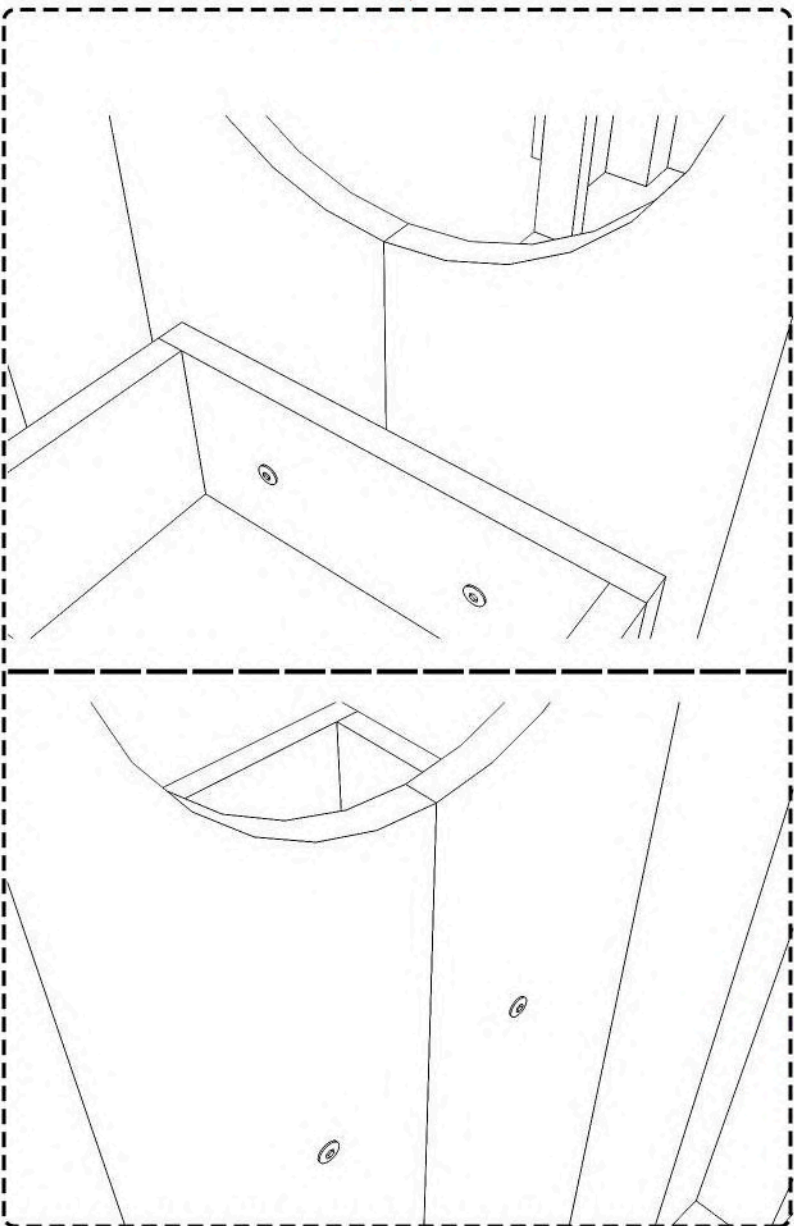

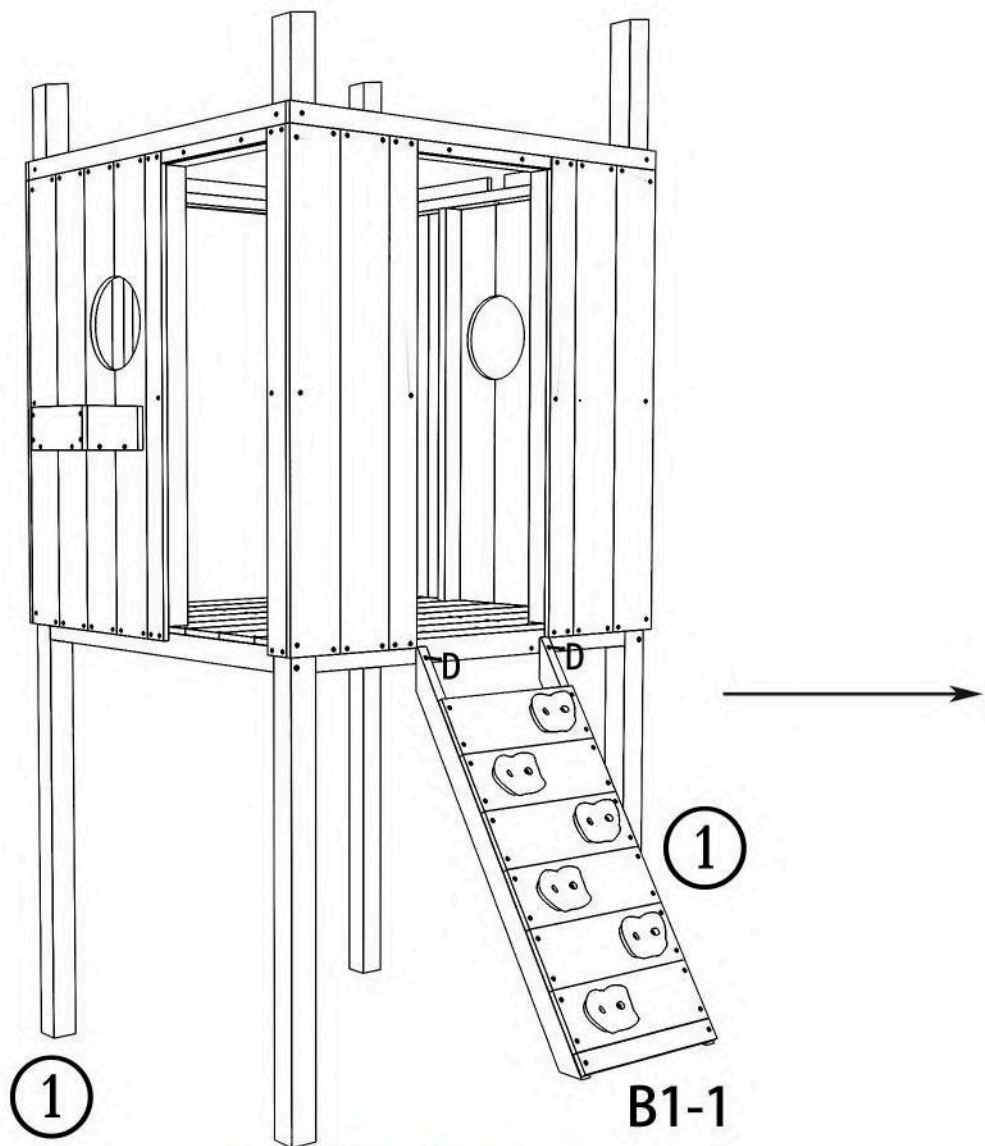

B1-1

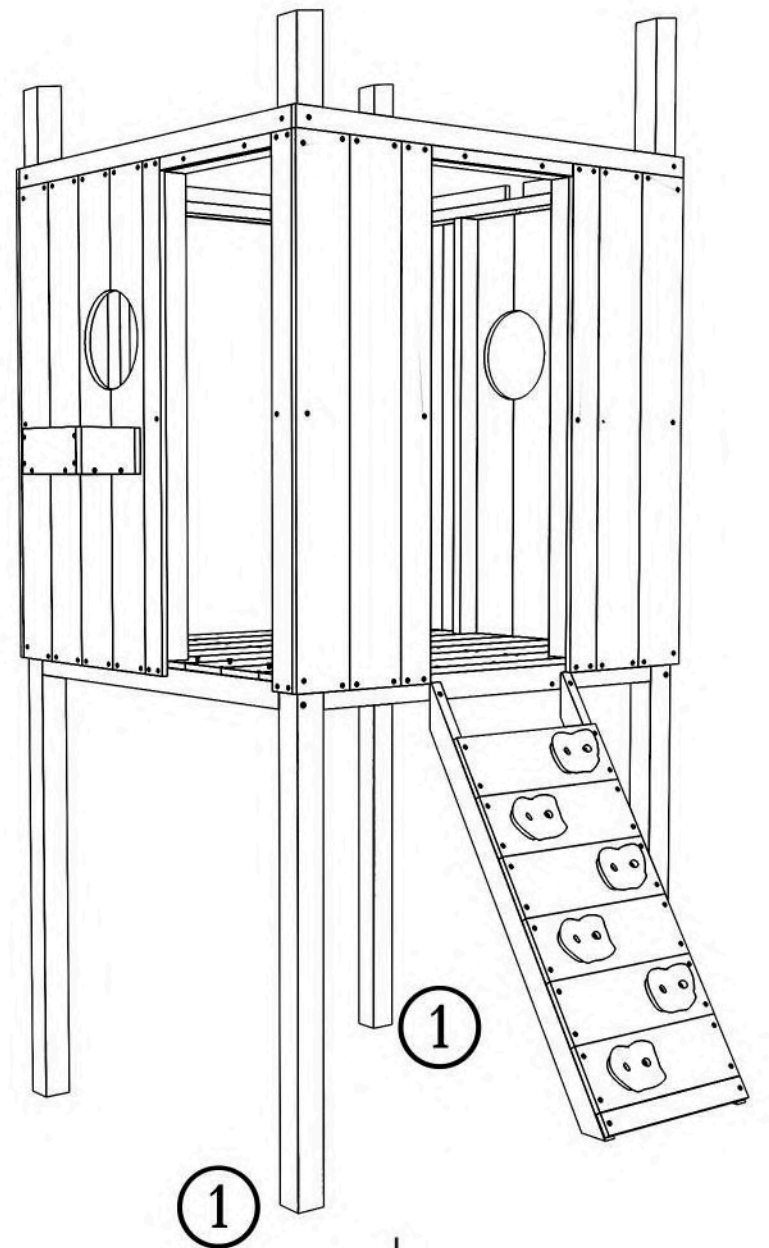

1

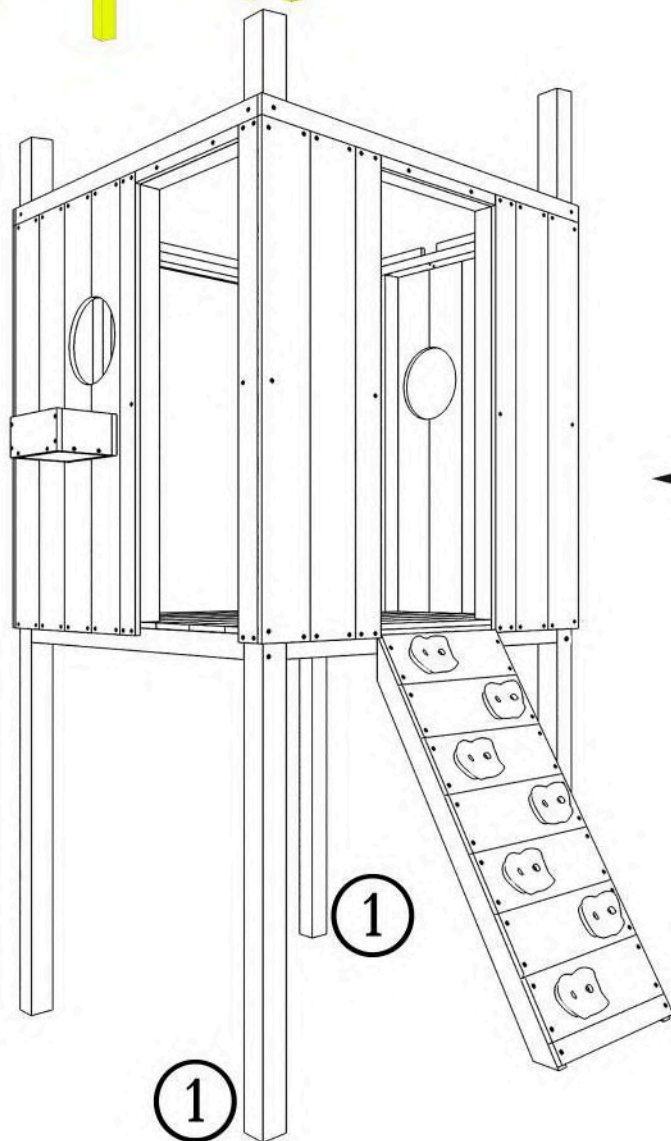
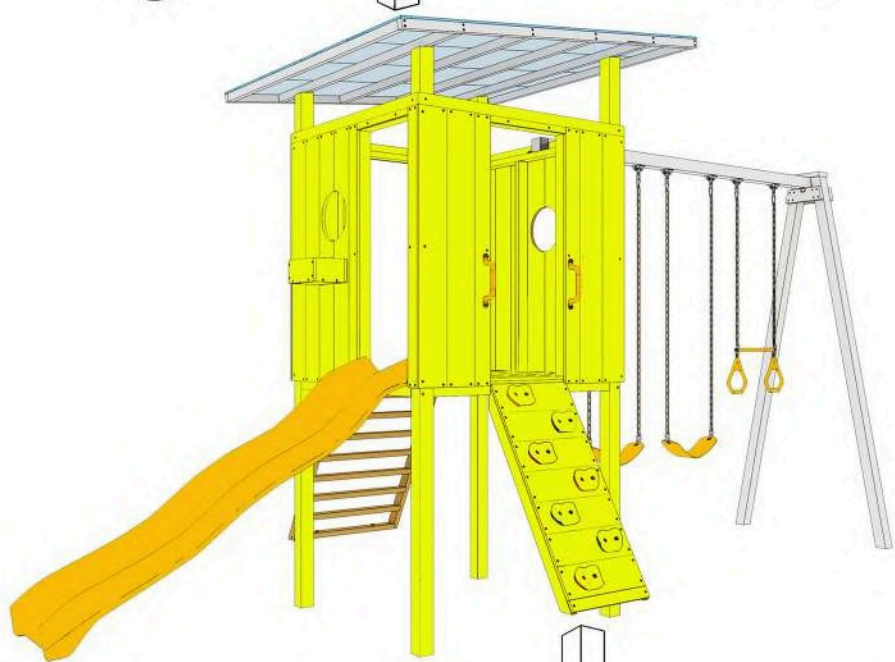

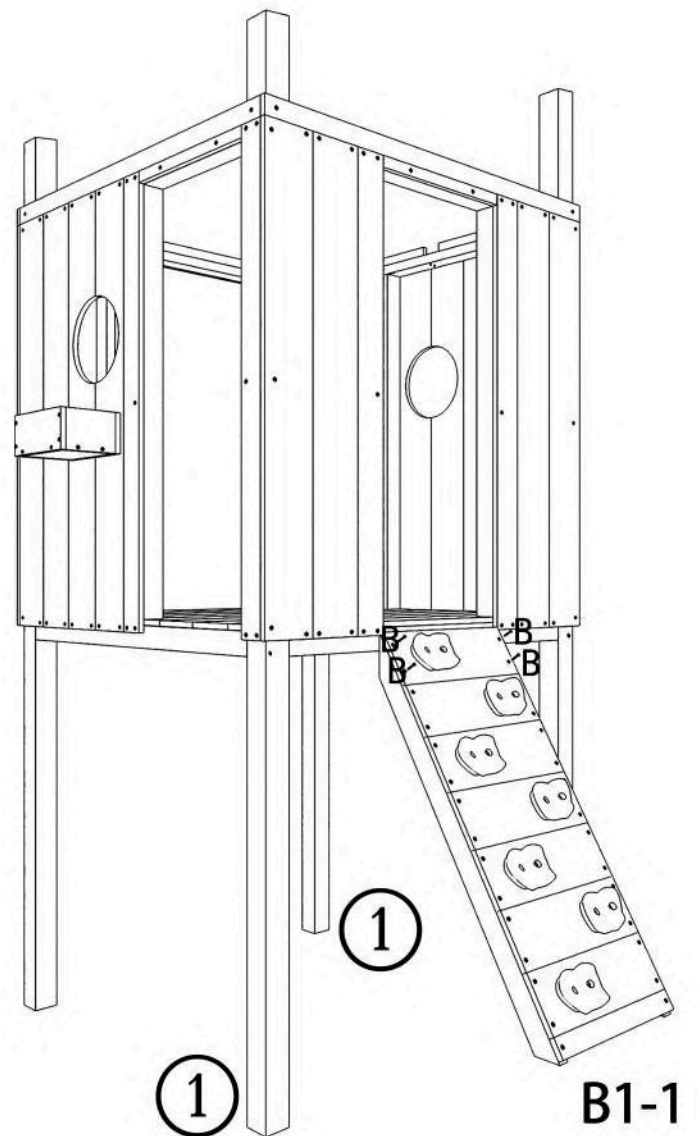

1



1

B1-1

B	 M5×30	4
D	 M5×50	2

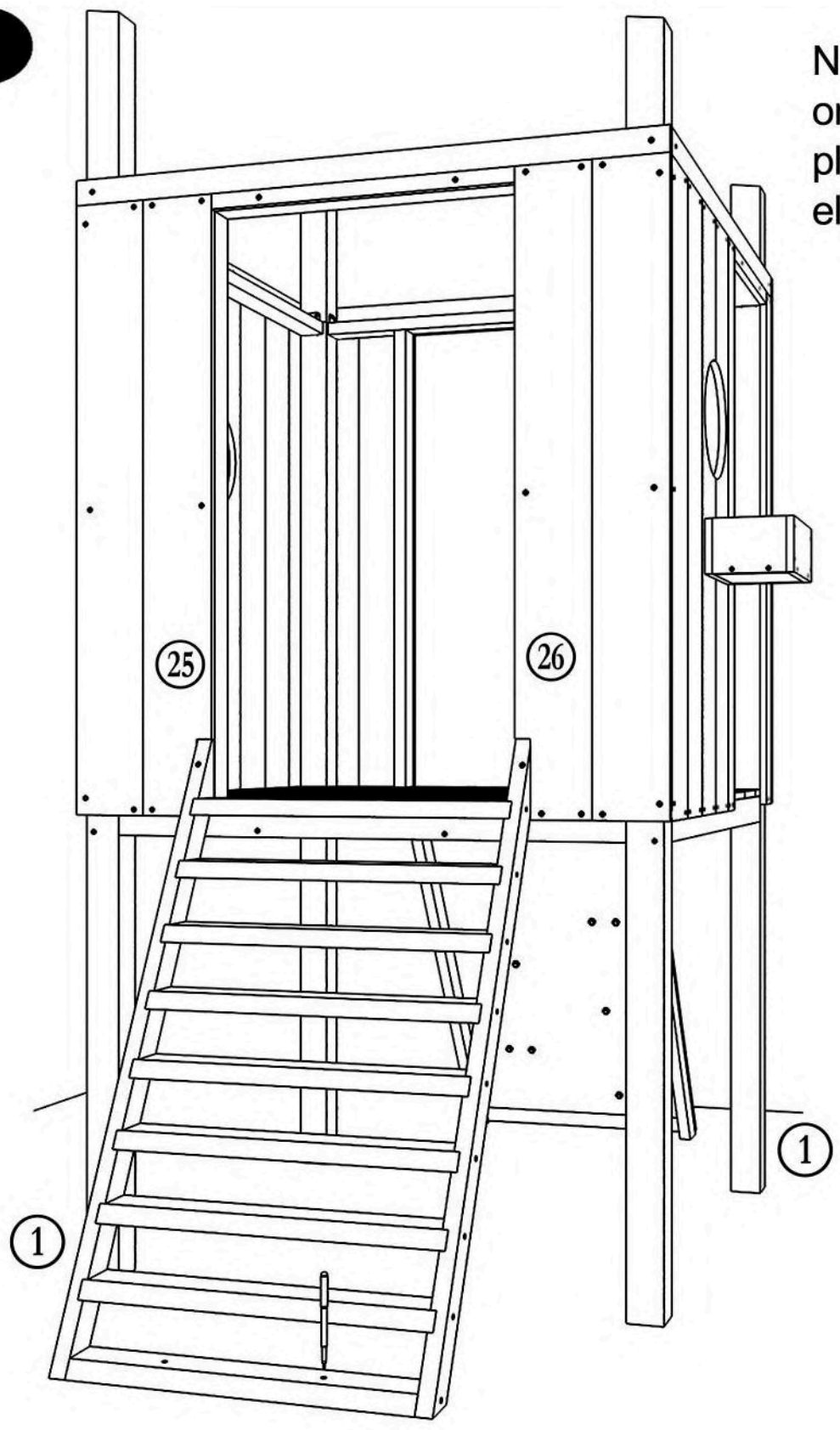

NOTE: As shown in the picture, place part E1-1 on side Z, draw 2 points on the ground of the base plate position, remove the E1-1 and then use electrical drill to punch 2 holes of sizes 8*50mm

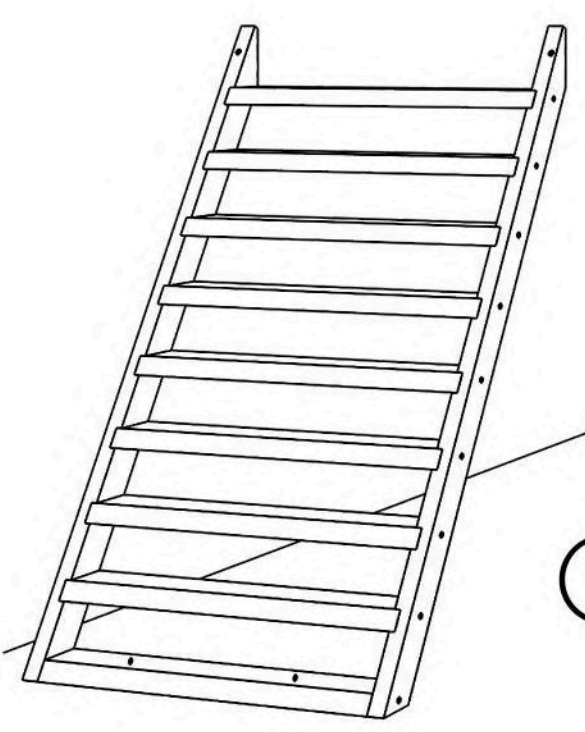
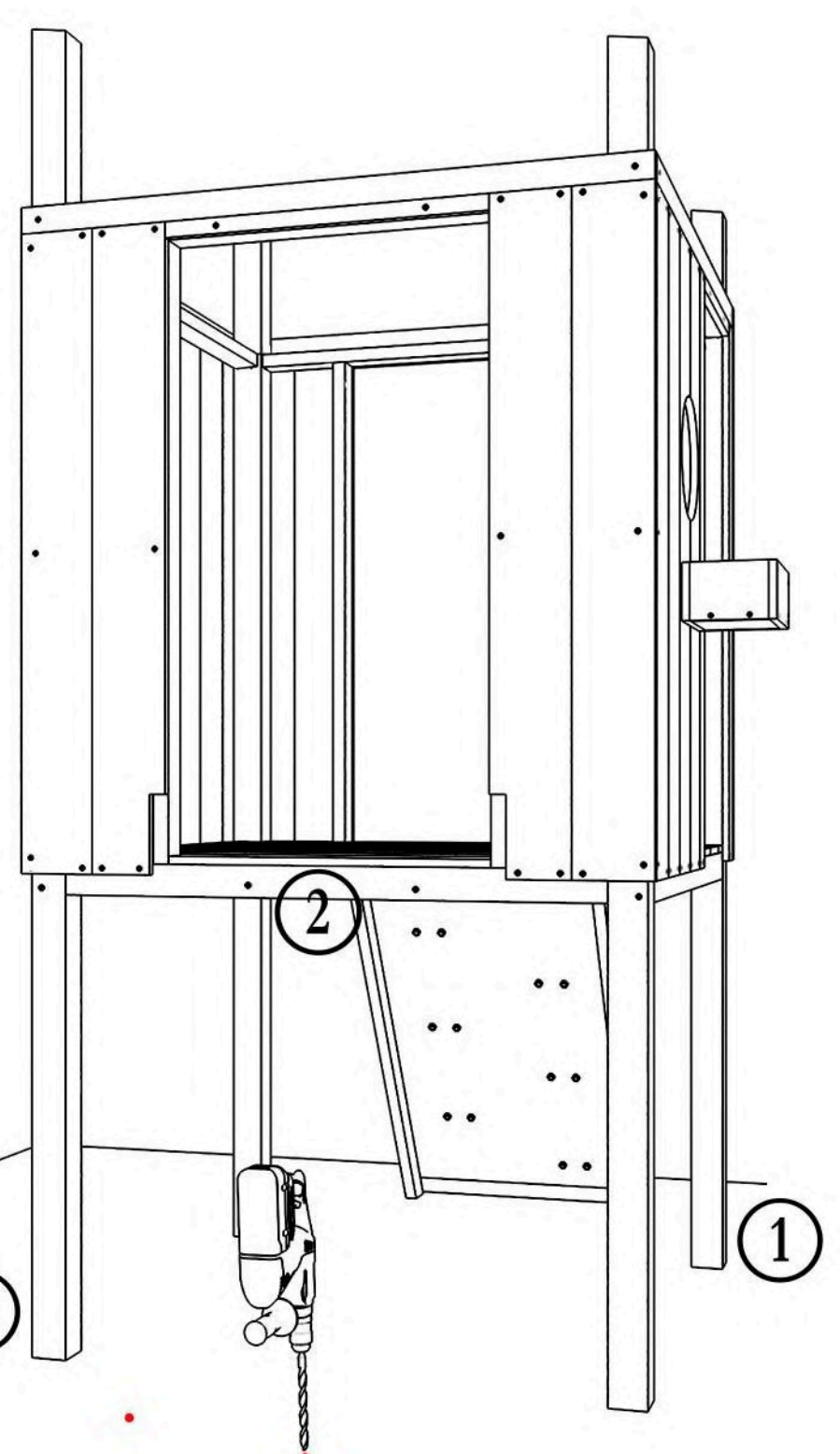

E1-1

J4-1

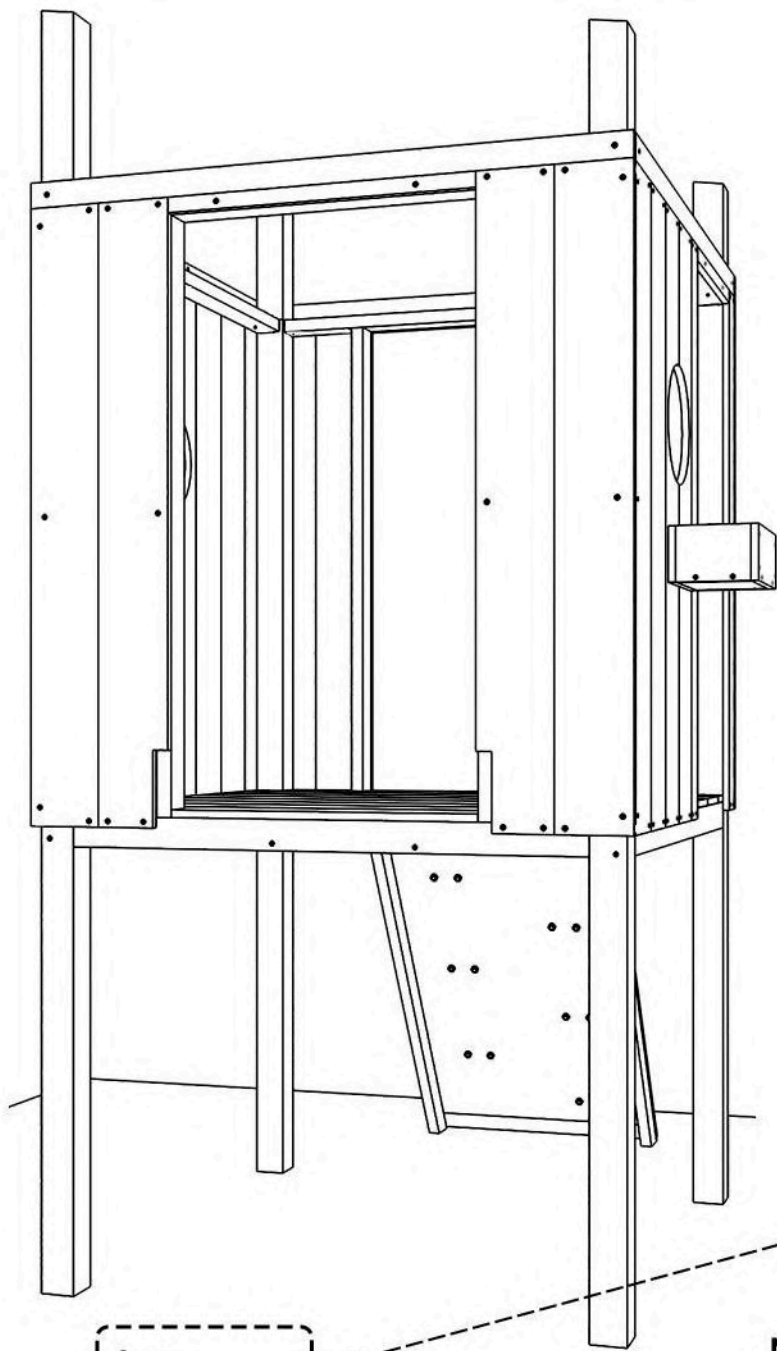

NOTE: Put parts F into the hole you just made

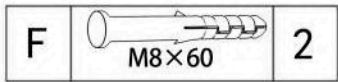

J4-2

NOTE: As shown, place part E1-1 on the side Z, and screw parts D to fix it.

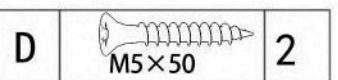
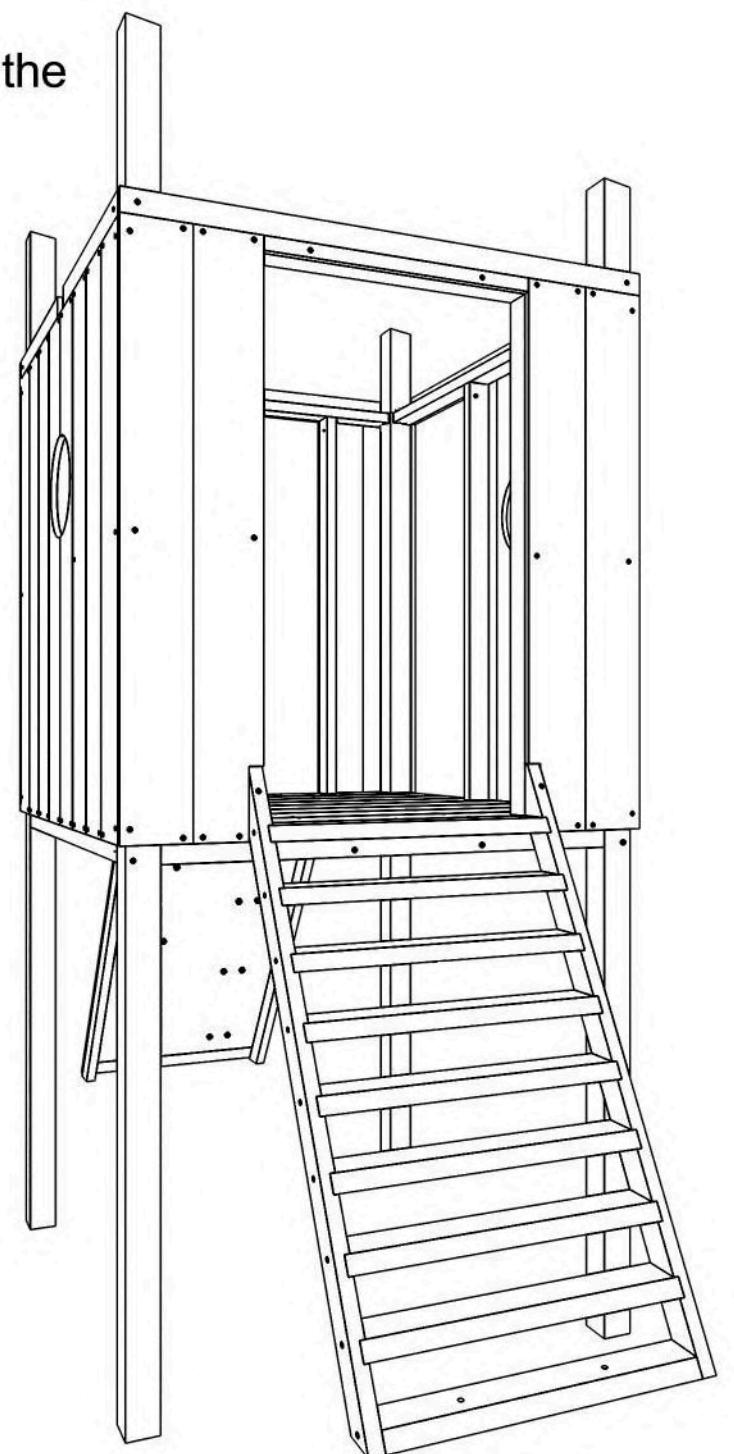
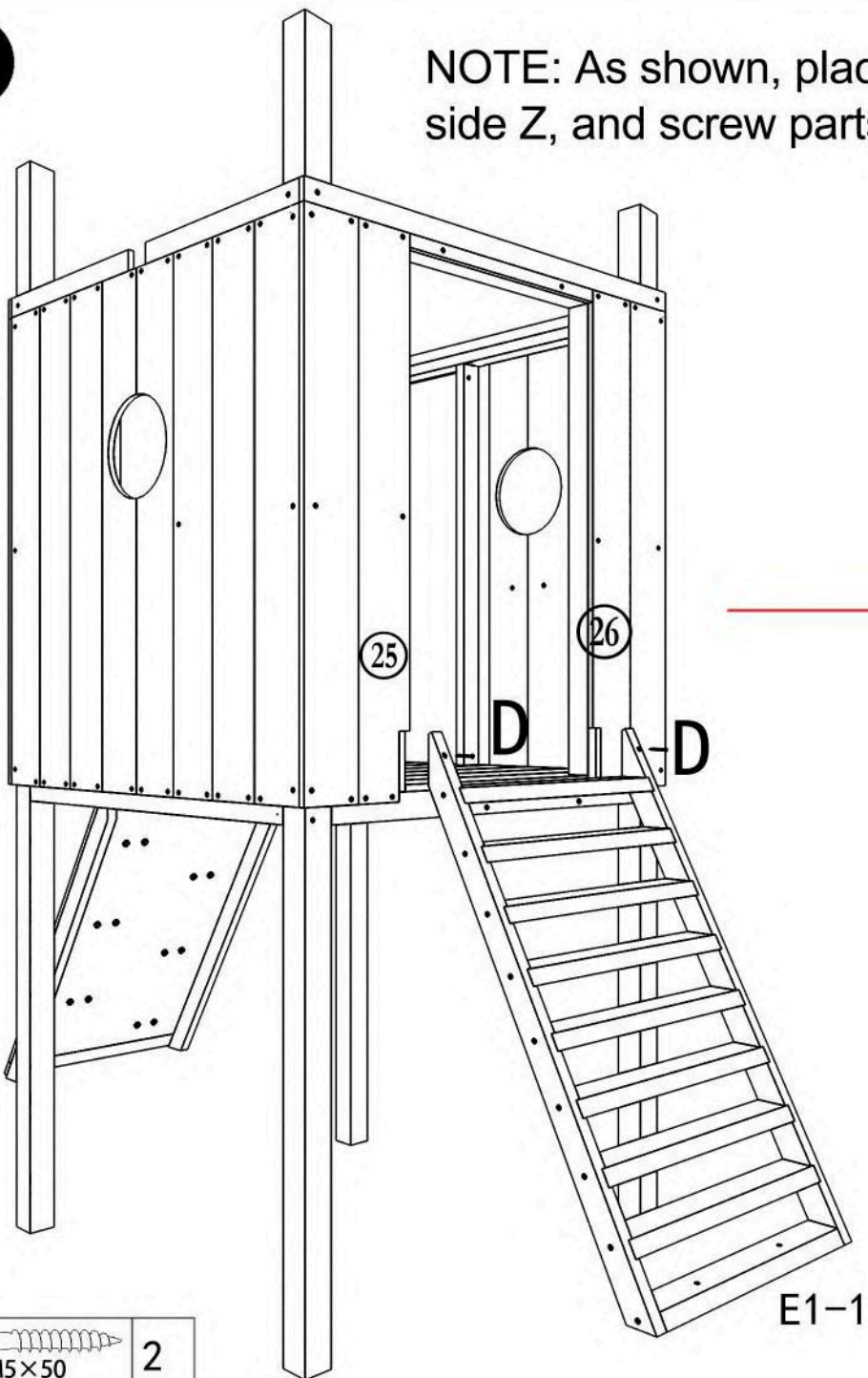

J5-1

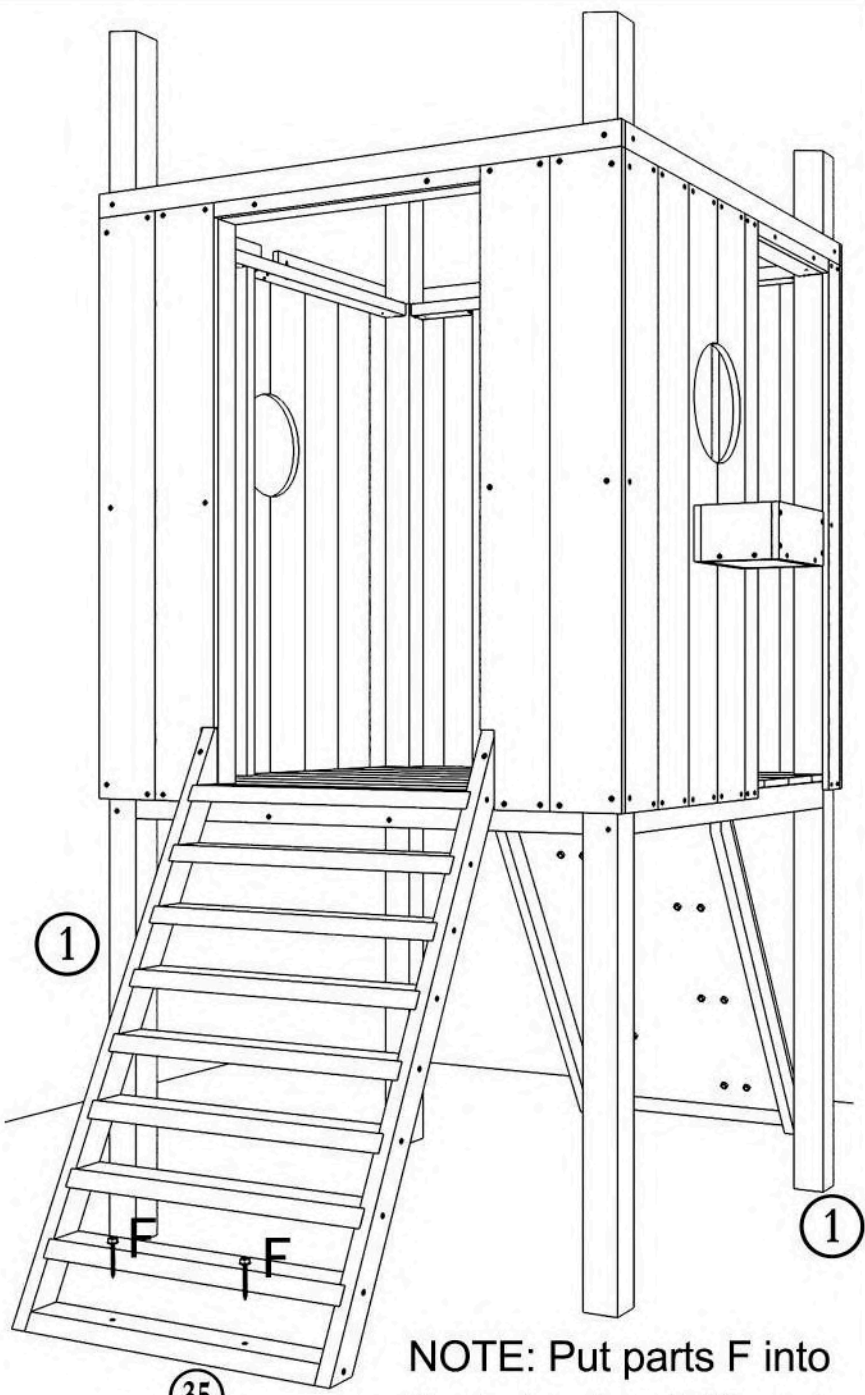

NOTE: Put parts F into the hole of part 35 and tightened

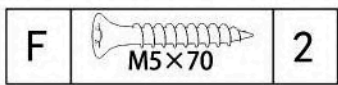

J5-2

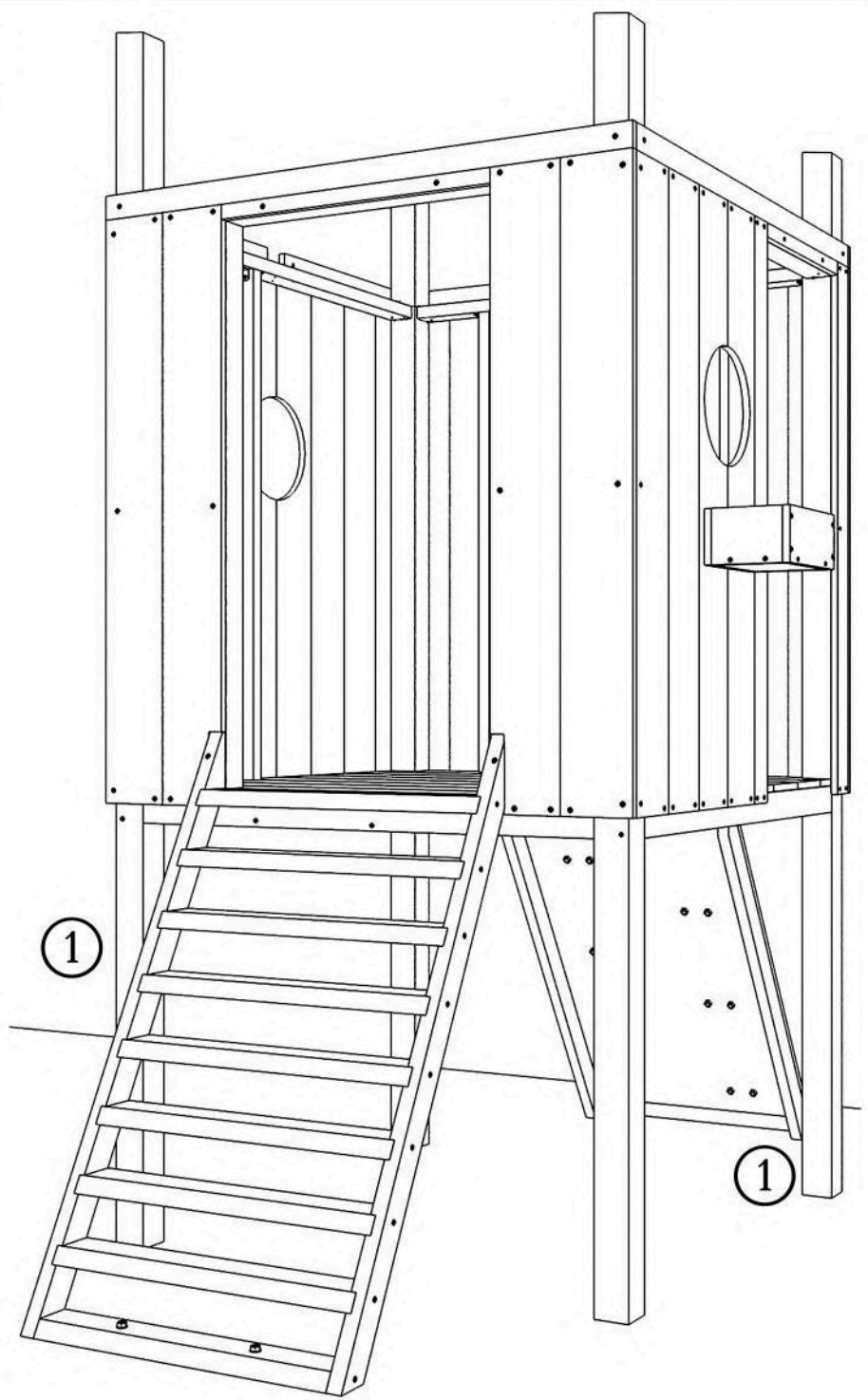

J5

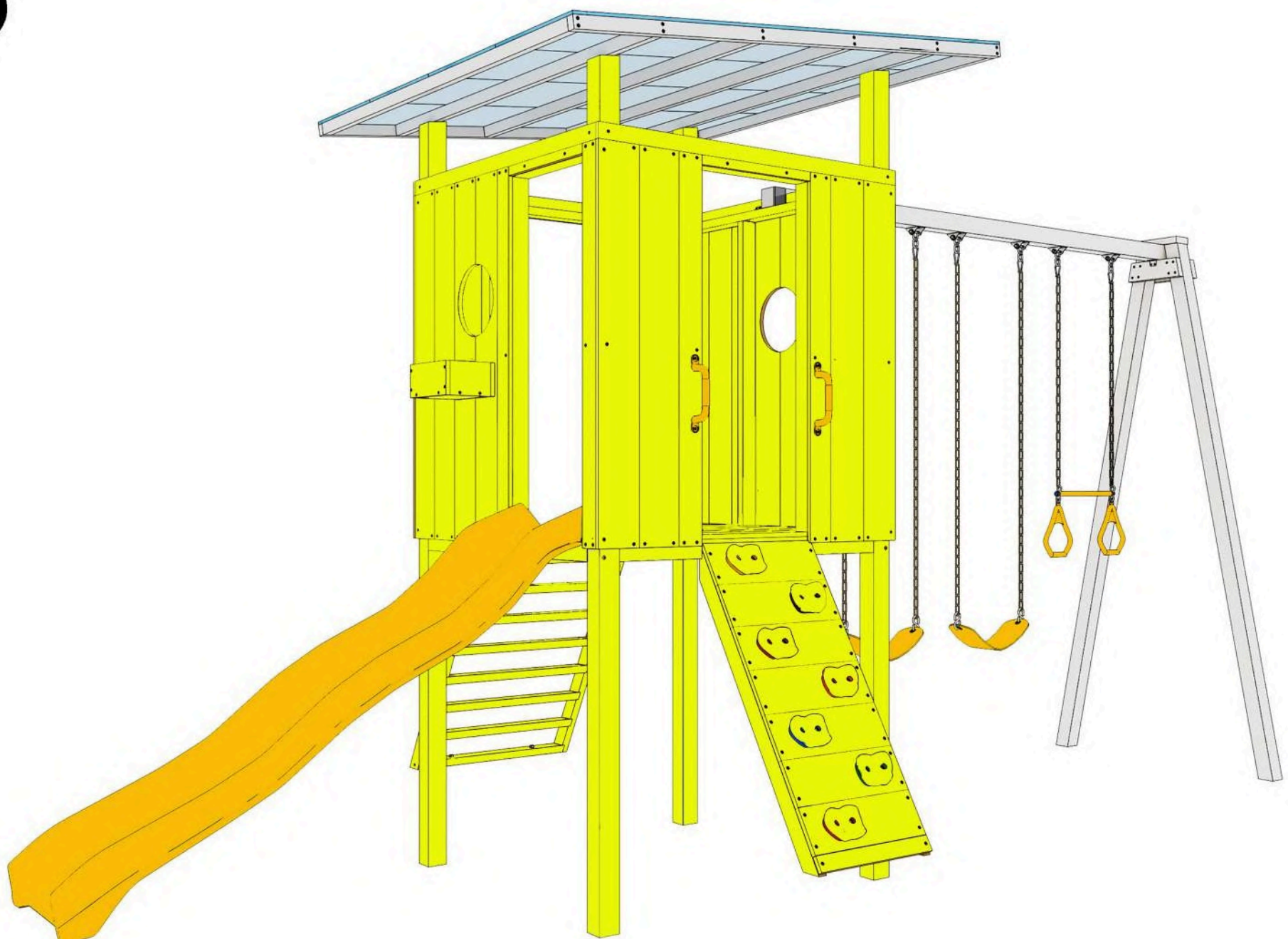

J6-1

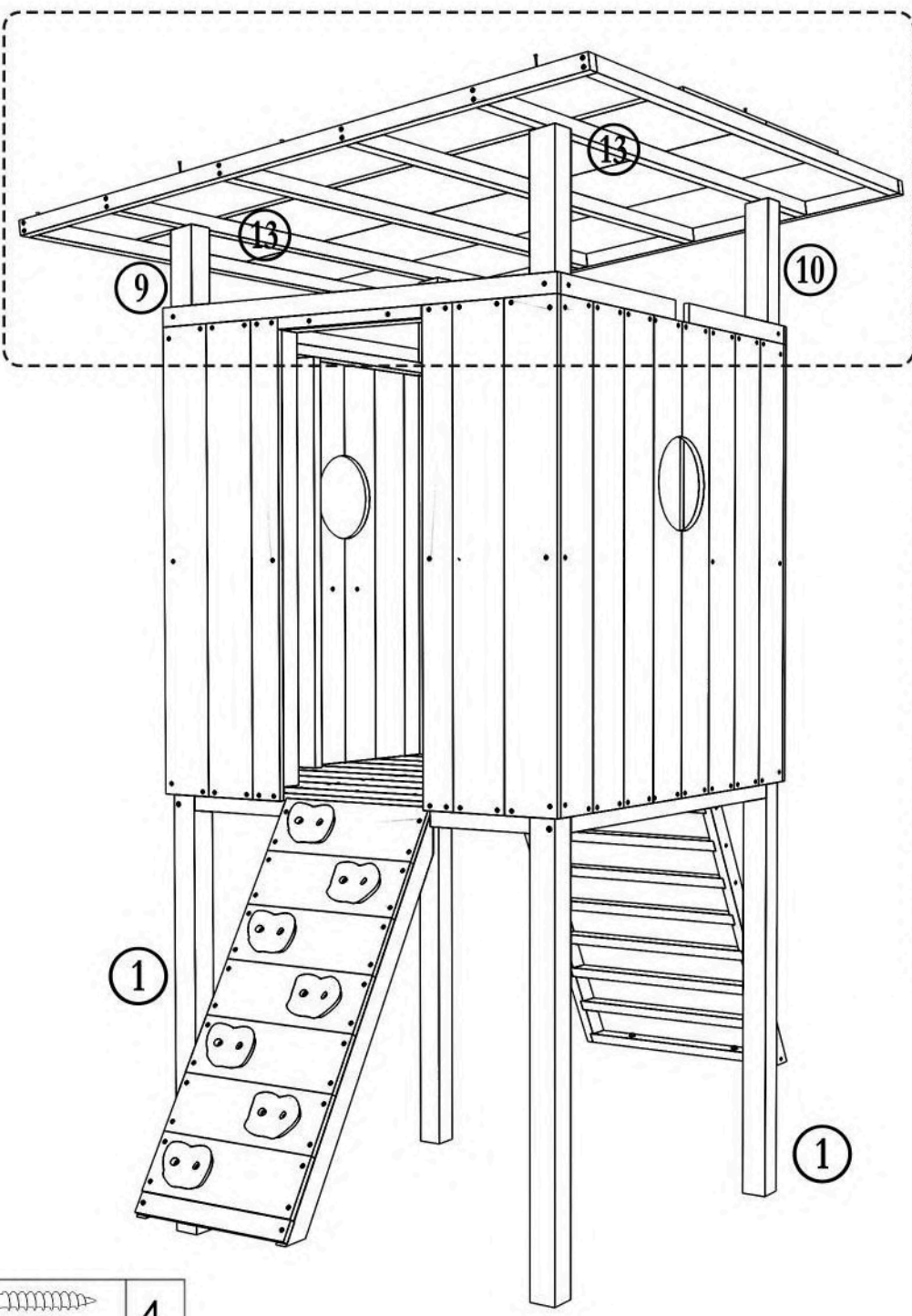

NOTE: Attach the sun shield. Using screw E, attach part 13 to posts 9 & 10

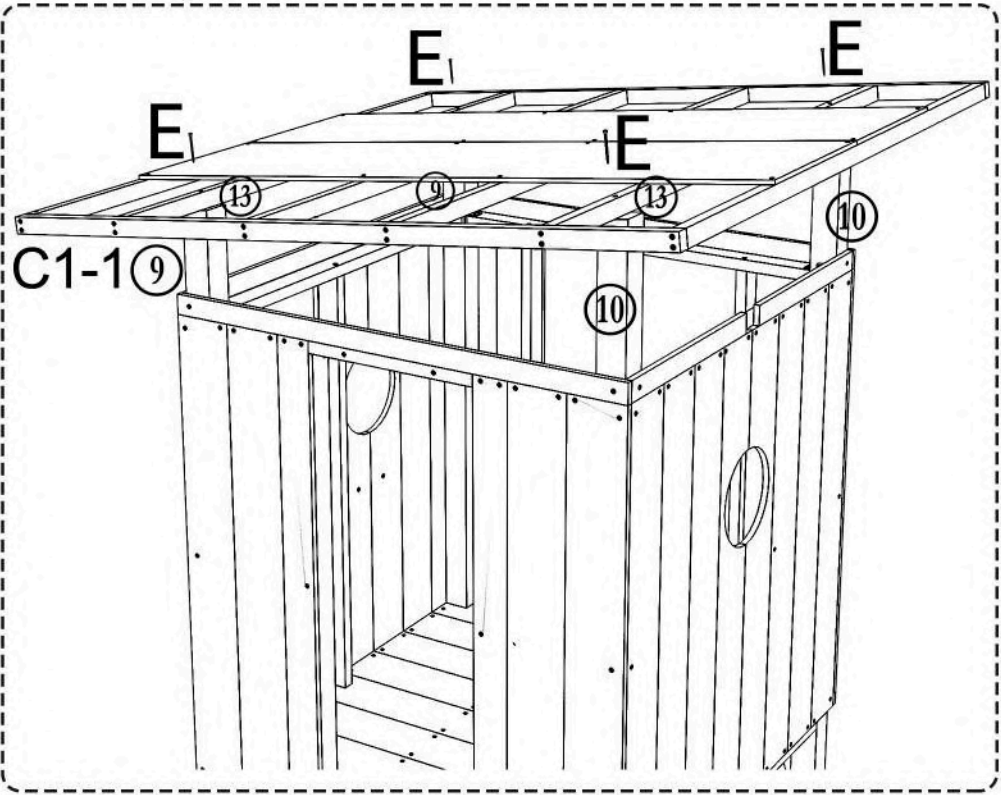

E		M5x70	4
---	---	-------	---

J6-2

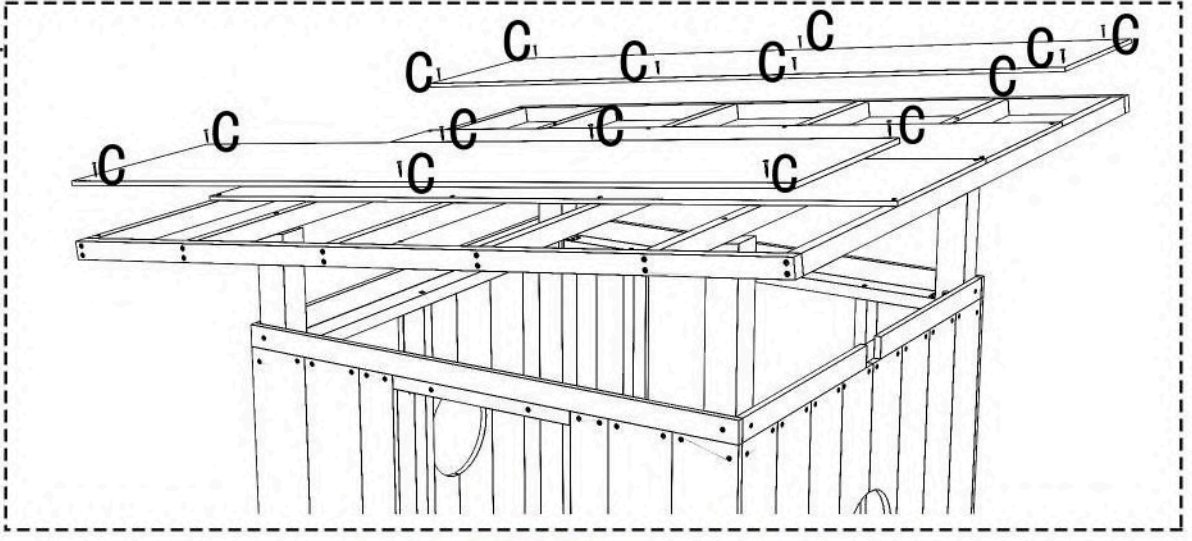
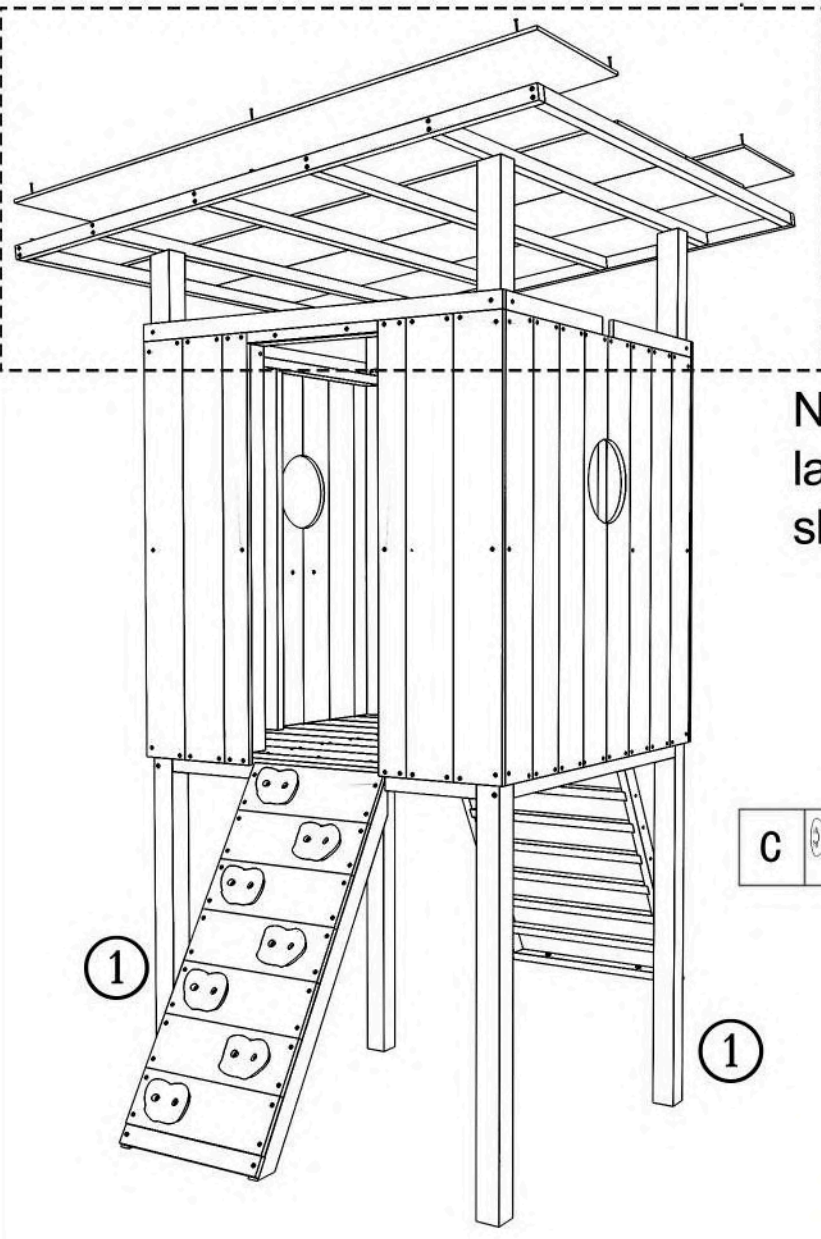

NOTE: Attach the last two sun shield panels

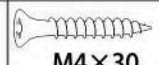
C		M4x30	14
---	---	-------	----

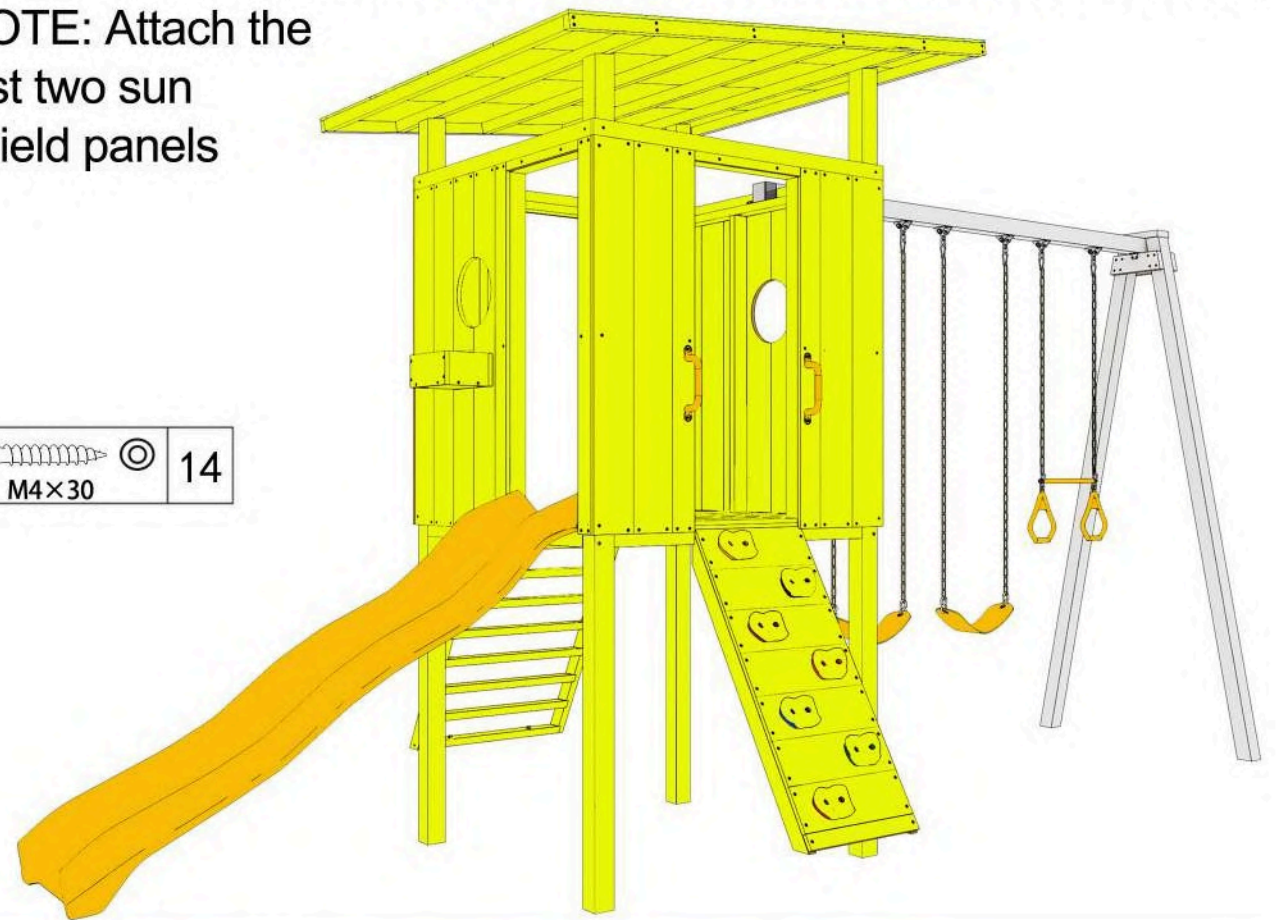

J6-3

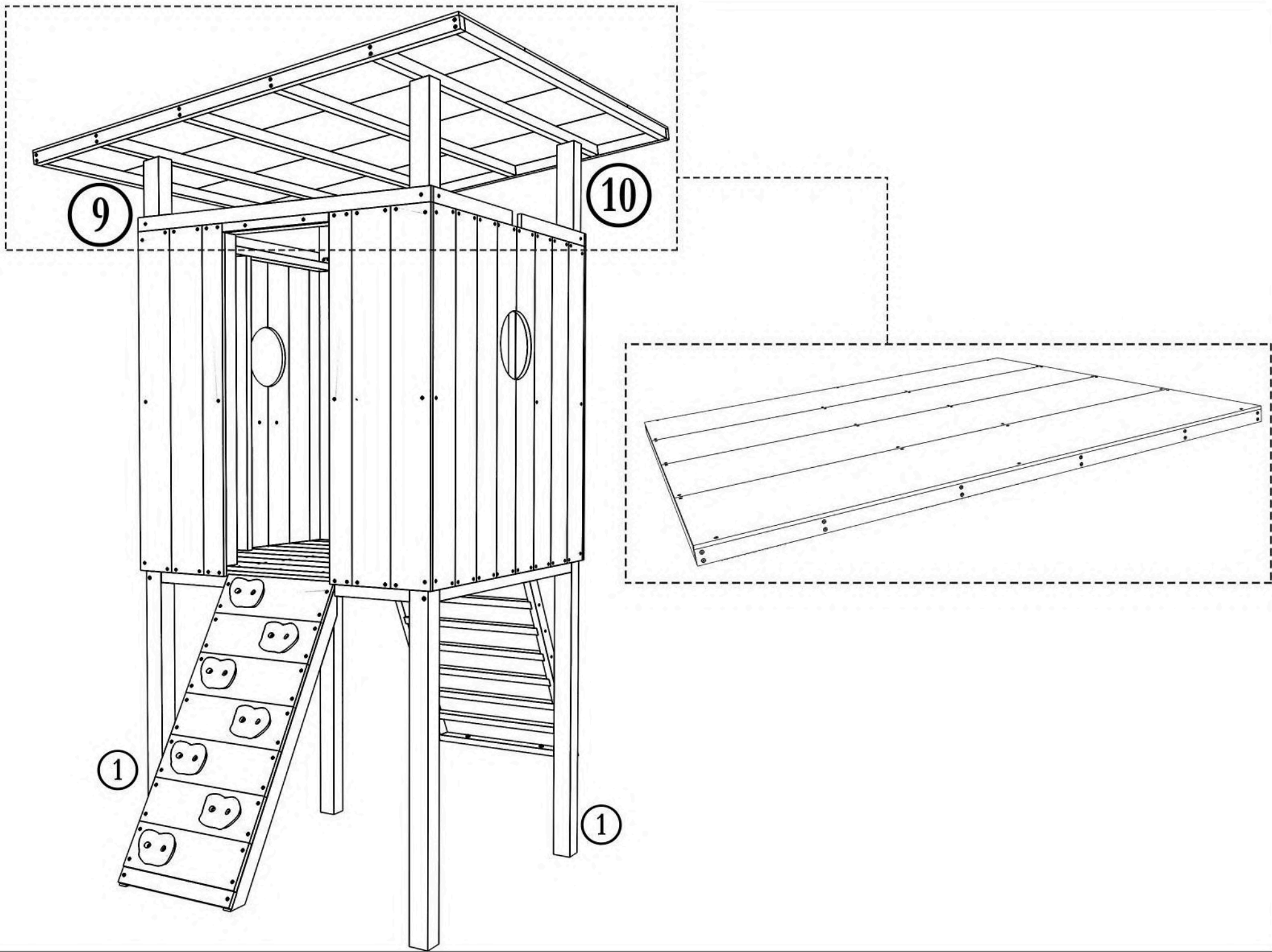

J6



NOTE:

1. Measure 88in from the house to the swing frame.
2. Dig 4.5" holes for each beam, place them in the hole. Make sure the beam is level and adjust if needed.

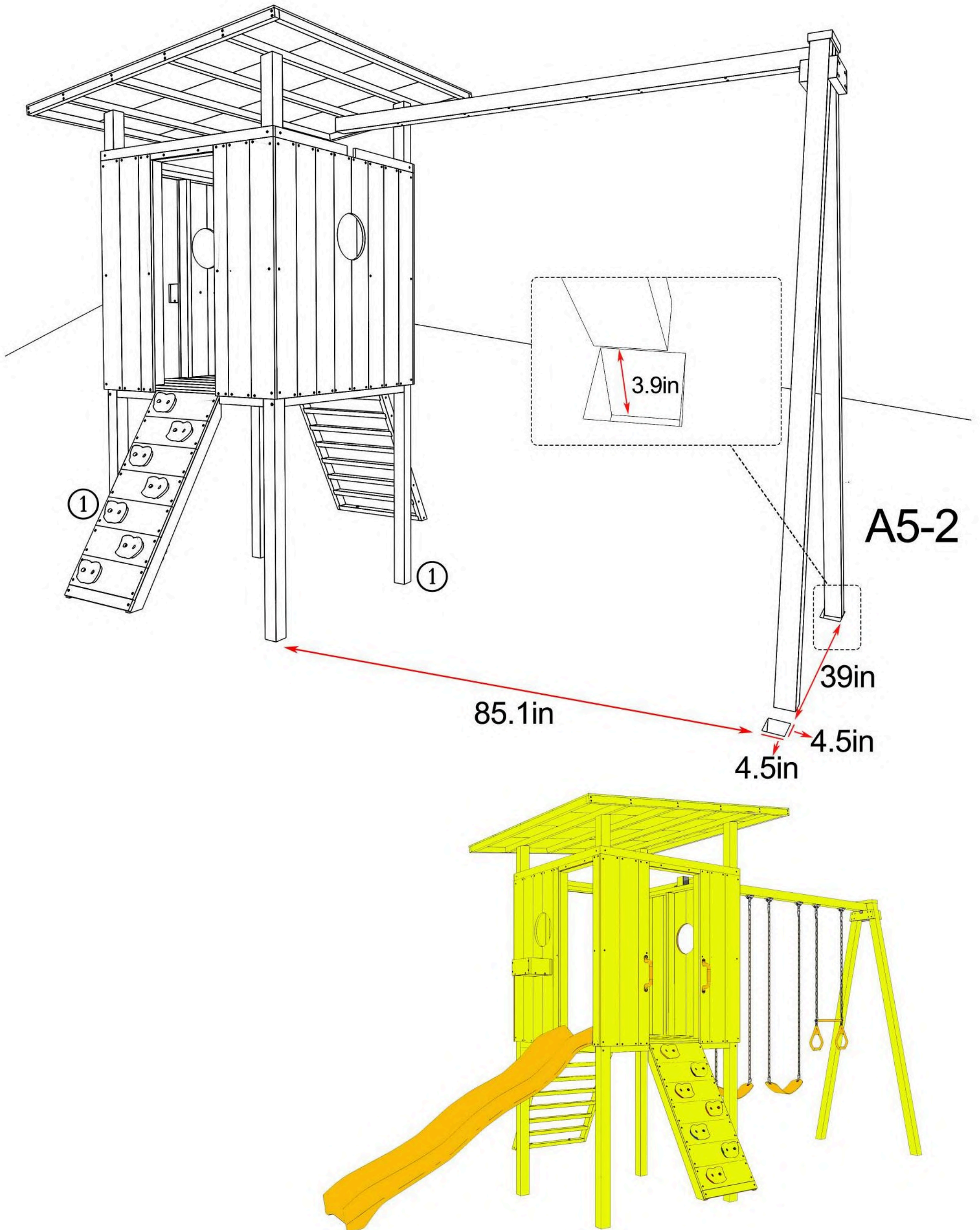

NOTE:

1. Place the swing beam #42 into the gap of the roof, where part 8 is.
2. Make sure the beam is flush with the inside of part 8.
3. Pour the concrete in the holes.

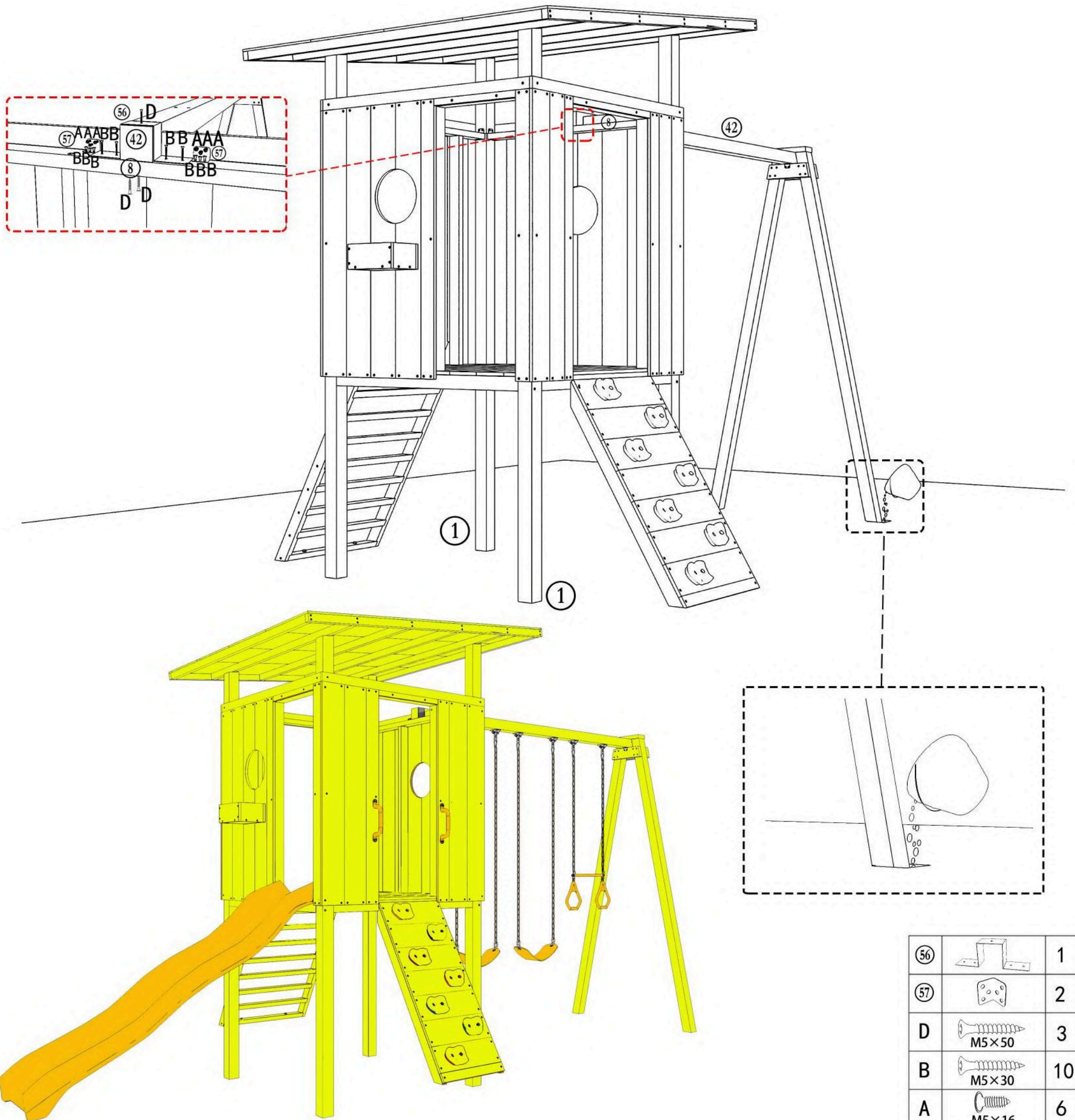

56		1
57		2
D	 M5×50	3
B	 M5×30	10
A	 M5×16	6

J8-1

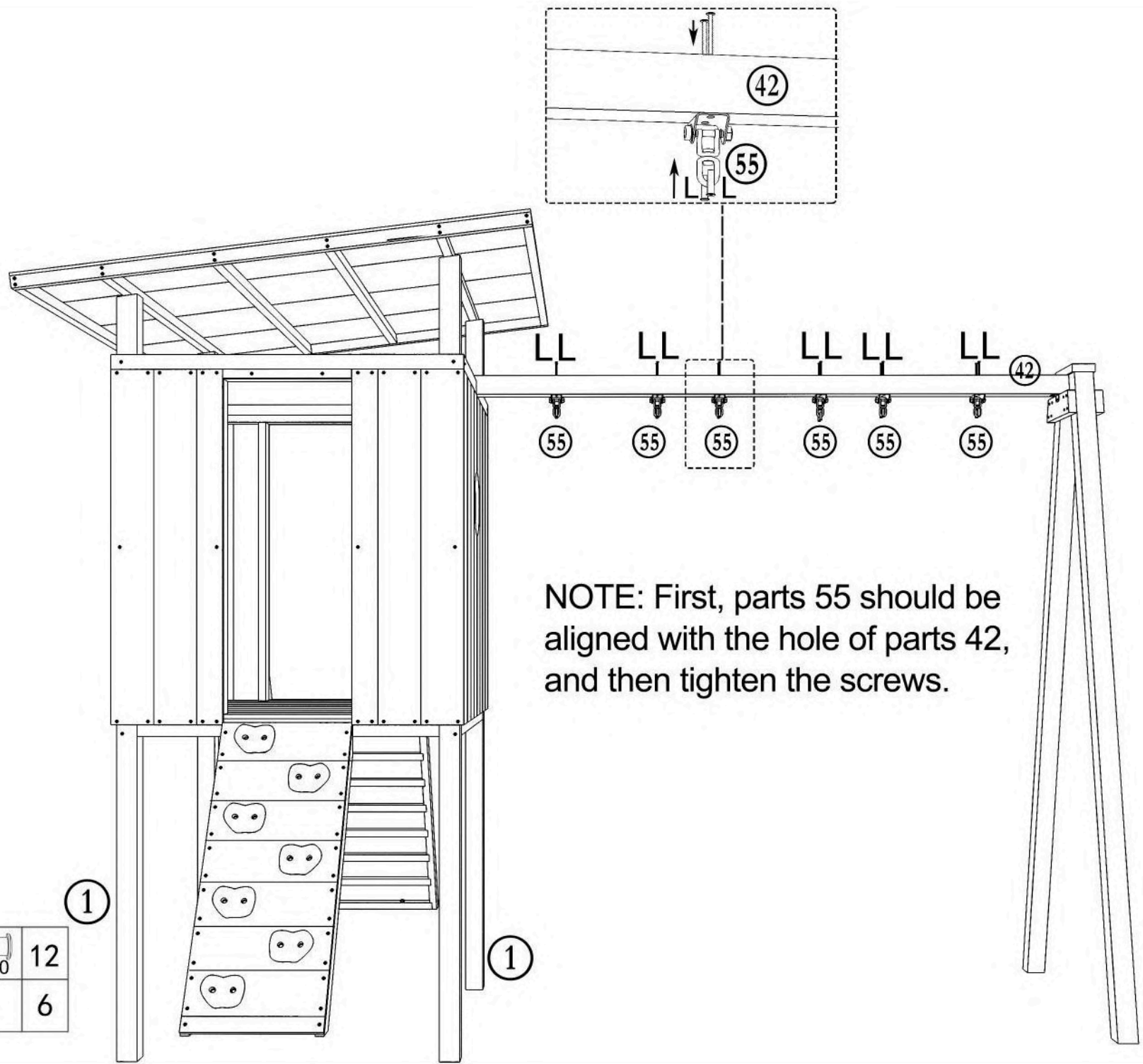

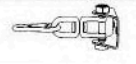
L		M6×60 M6×30	12
55			6

J8

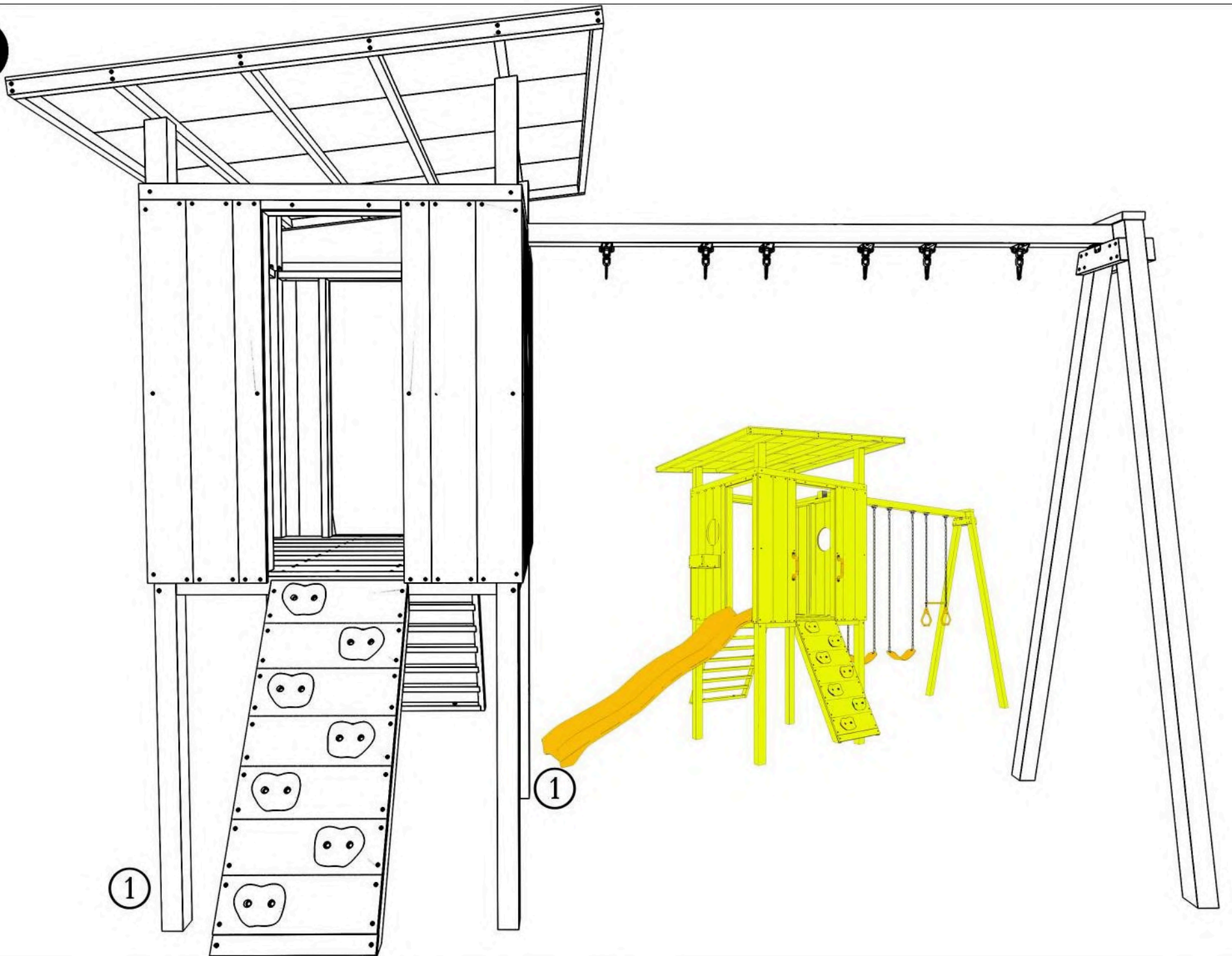

J9-1

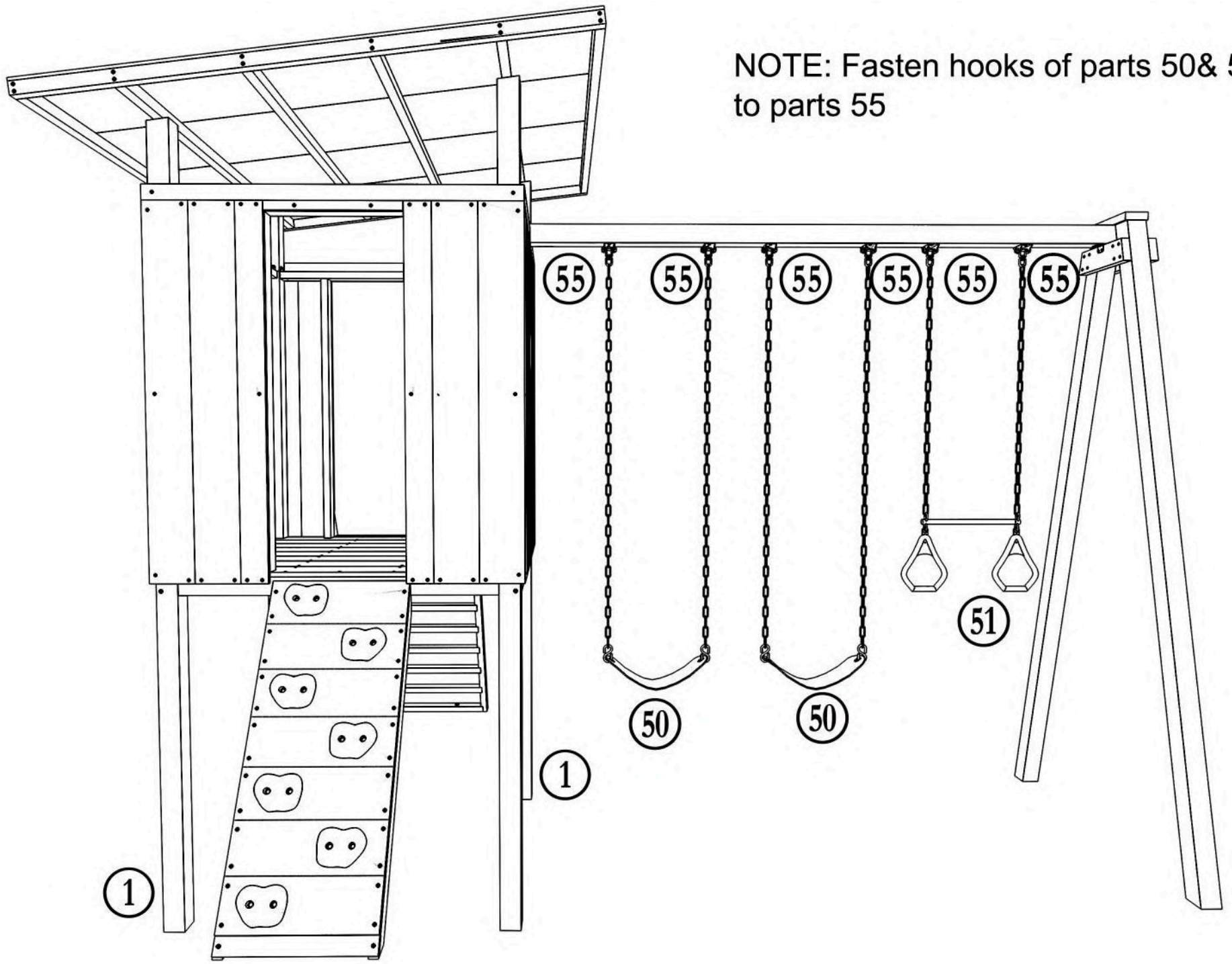

J9



J10-1

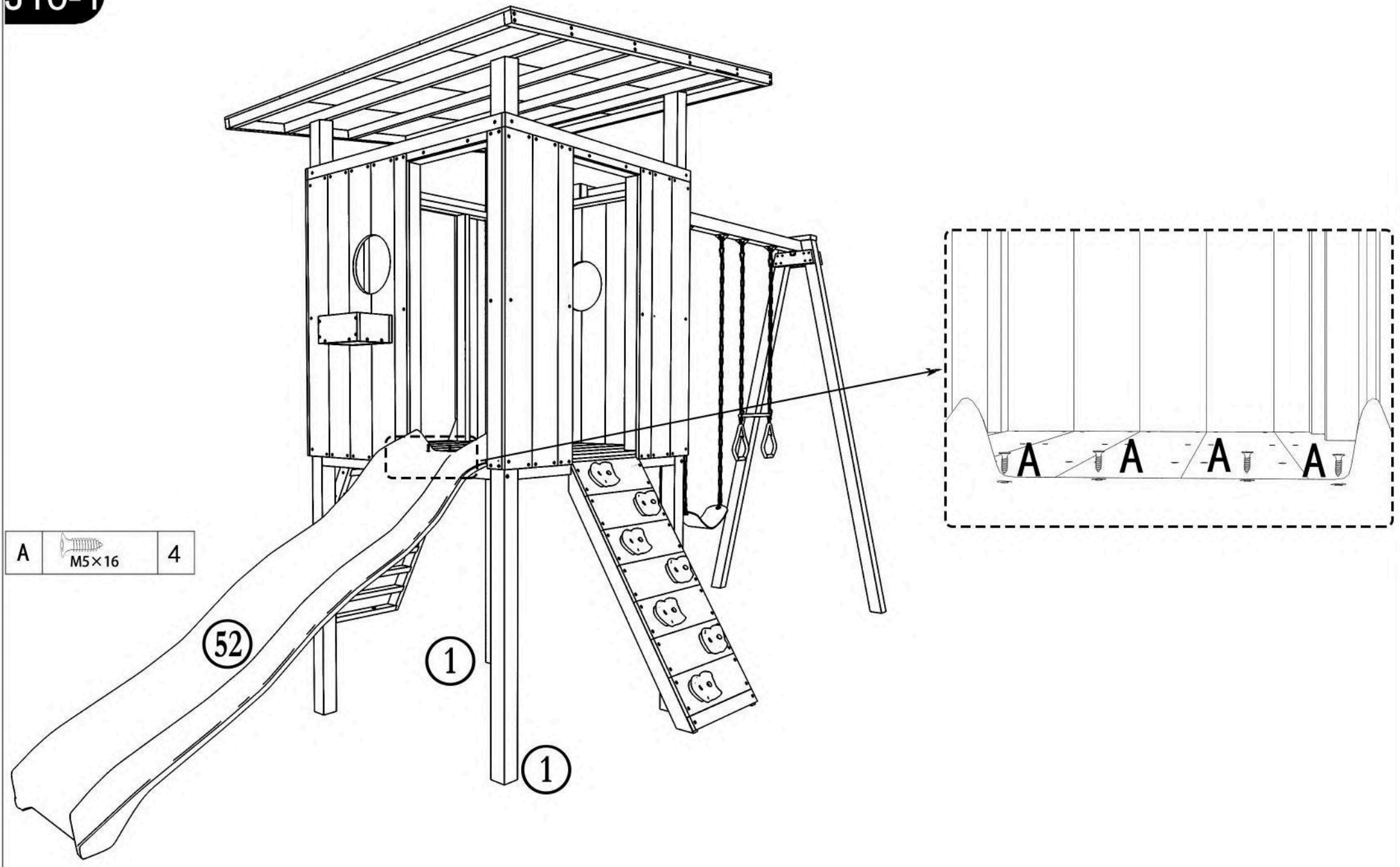

J10-2

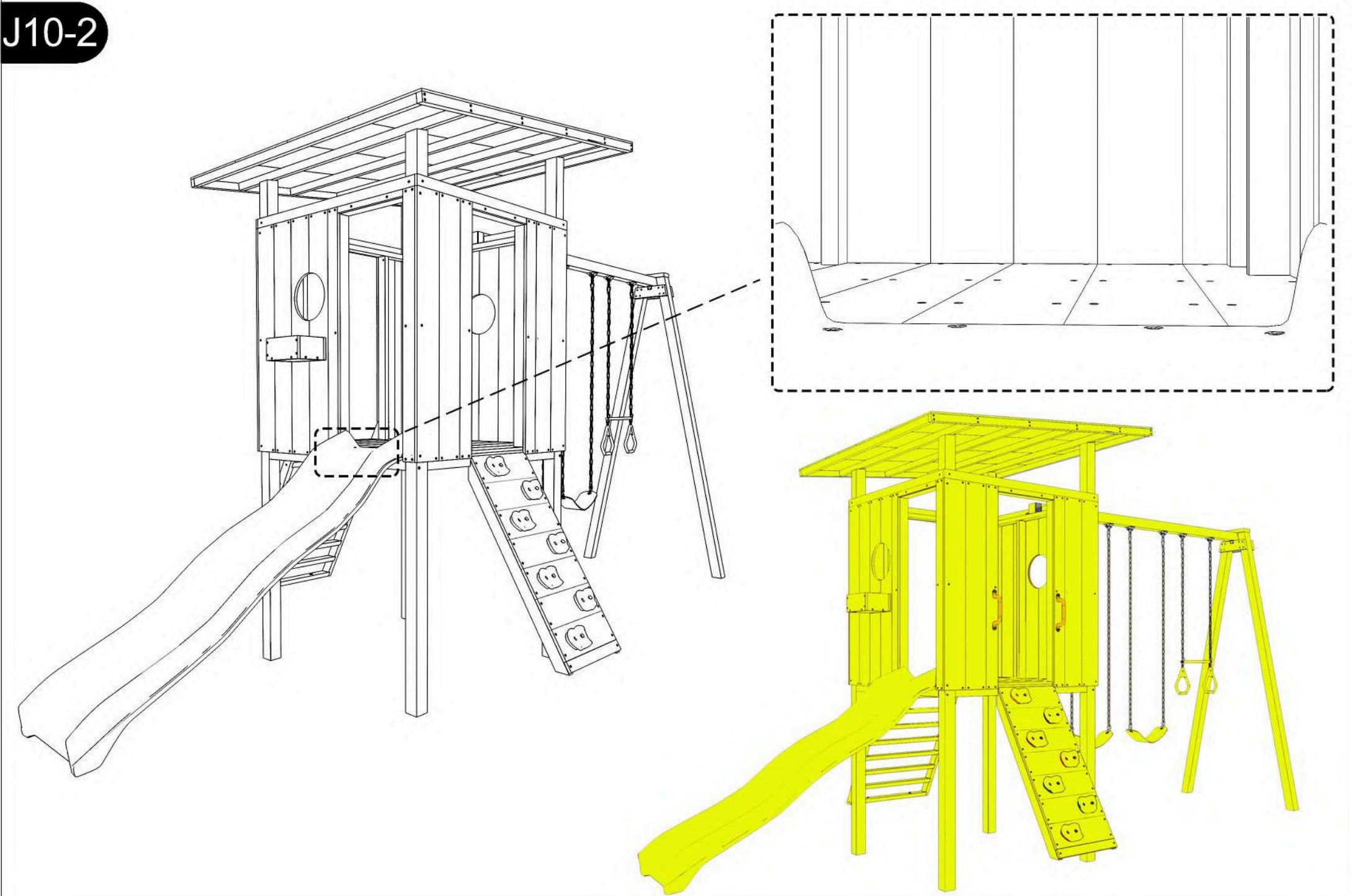

J11-1

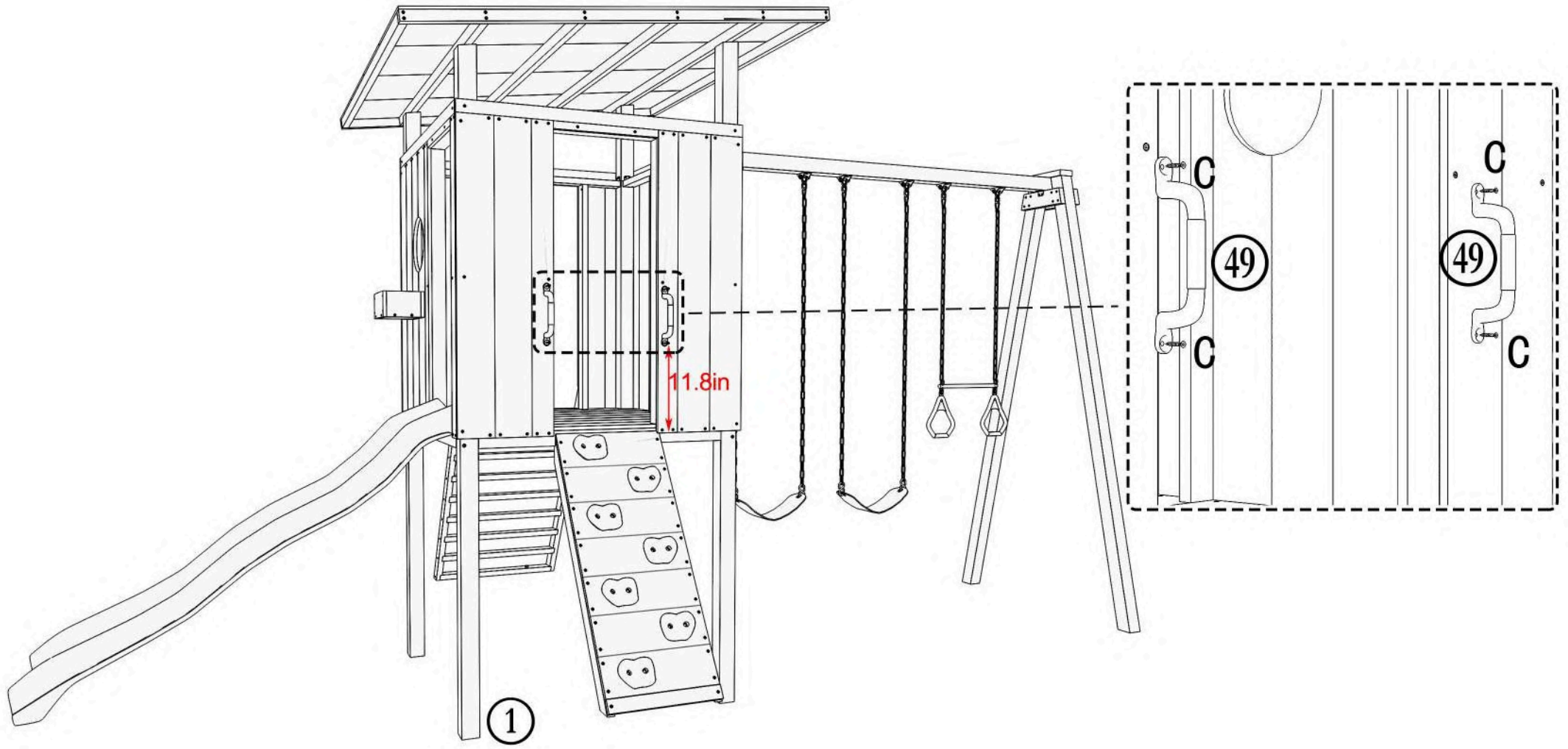

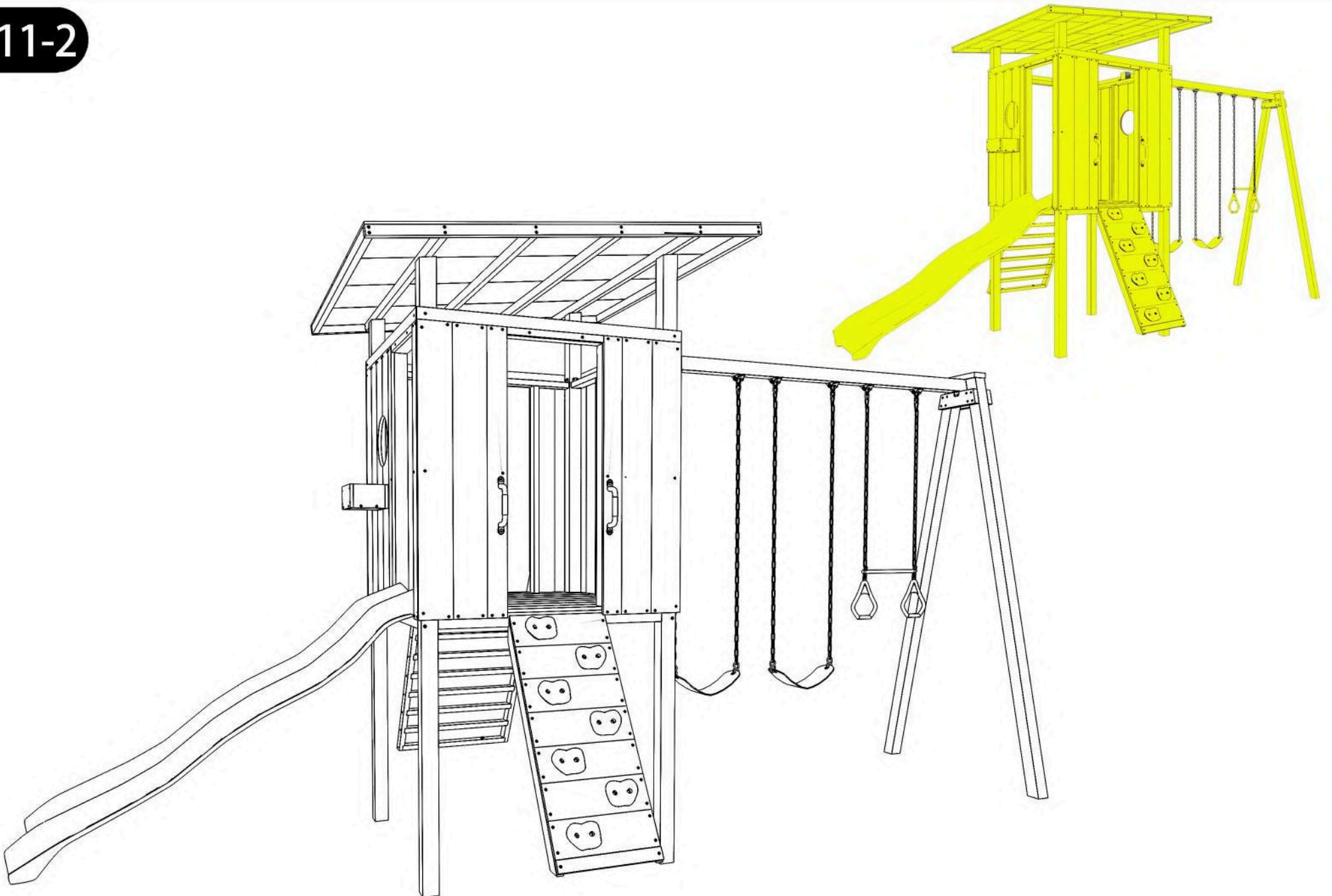

C M4x30 4

J11-2

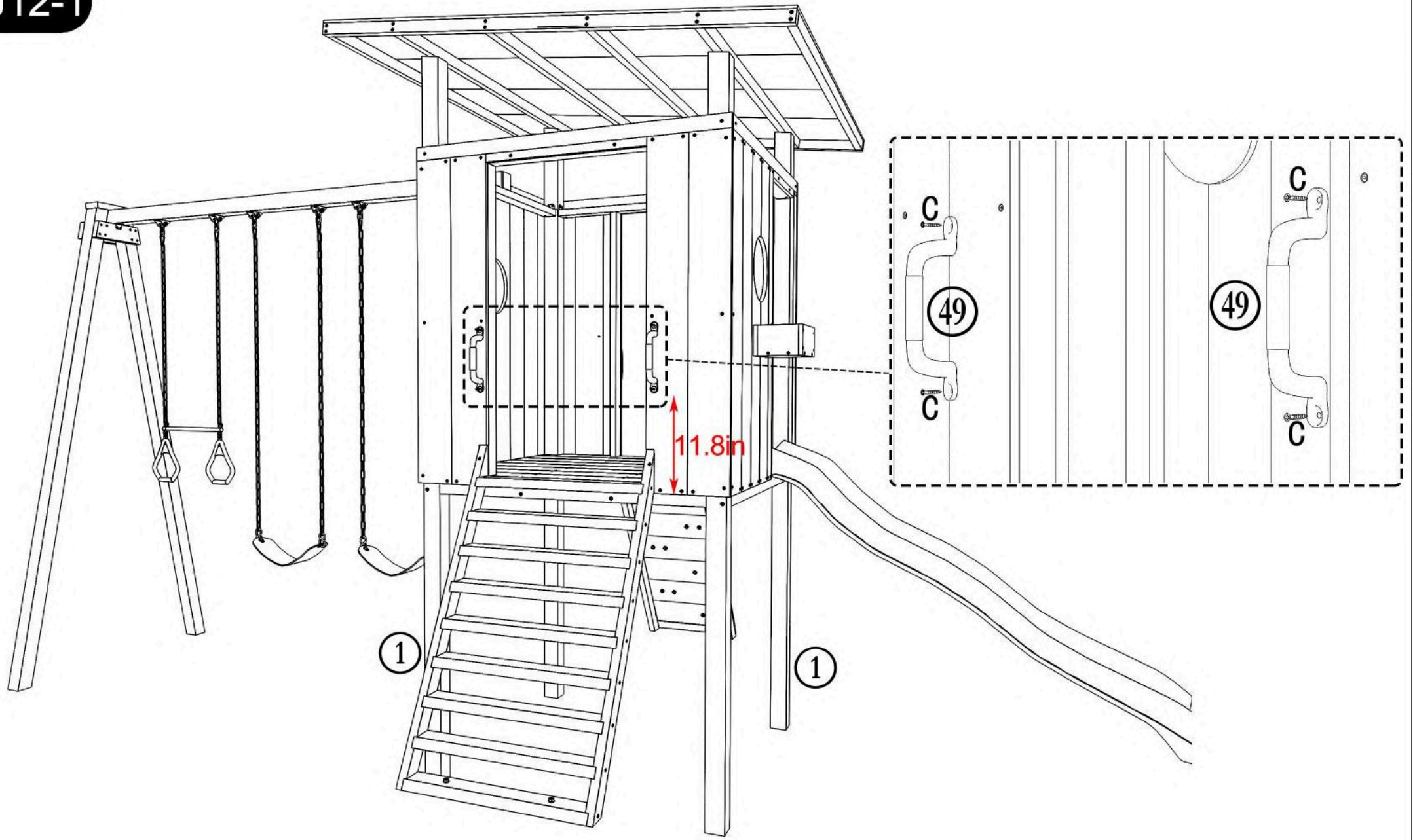

J12-1



C  M4x30  4

J12-2

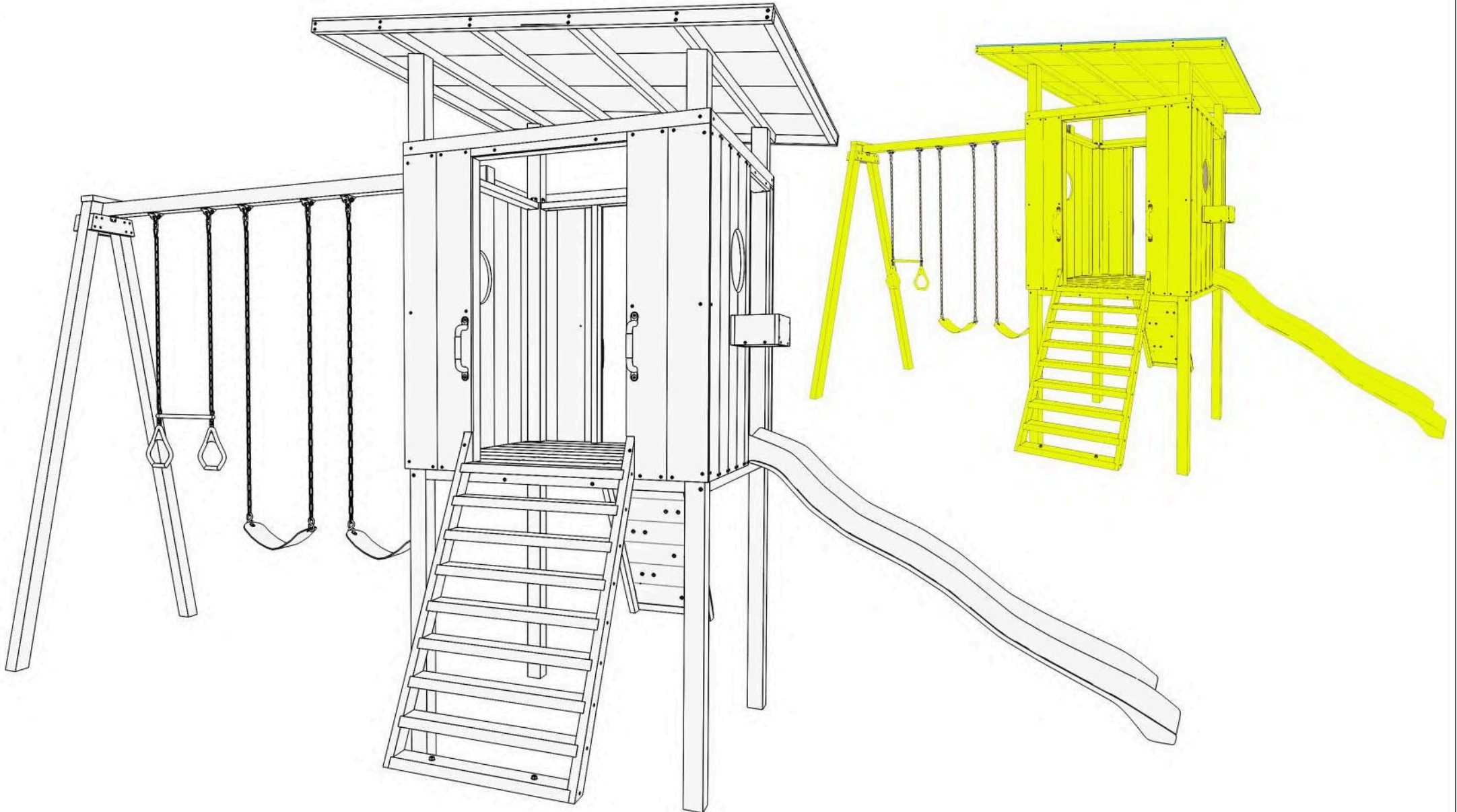

Note: It can be assembled differently according to different preferences

