

avenlur

Magnolia by Avenlur

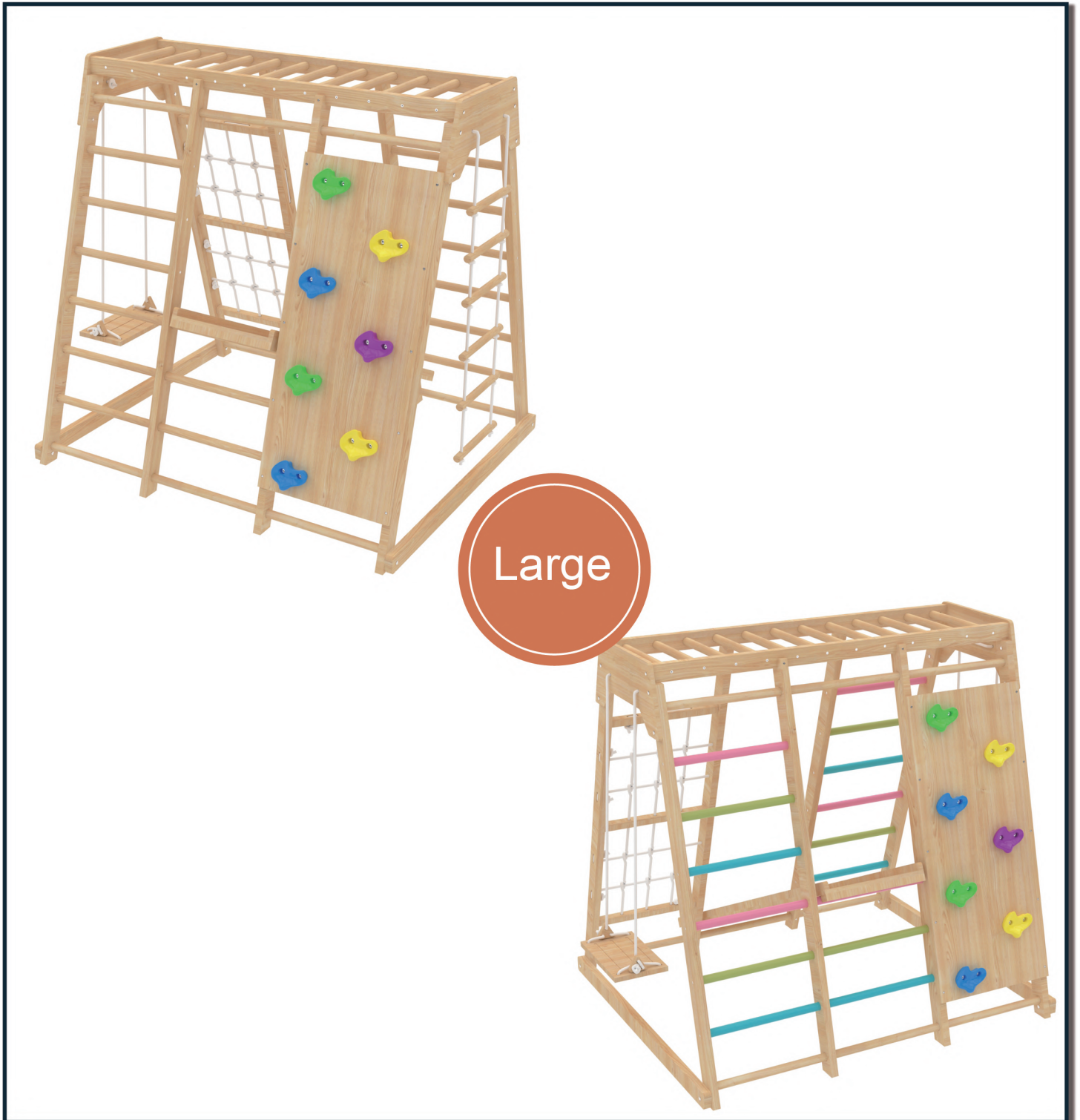

Need Help?

CALL US AT 888.697.3931 / M-F 9AM - 5PM PT (12PM - -8PM ET)

OR EMAIL US AT INFO@AVENLUR.COM

V2

⚠ WARNING

Adult assembly required.

⚠ WARNING

Maximum user weight: 110 lbs (50kg) per child

⚠ WARNING

⚠ CHOKING HAZARD:

Adult assembly required. Keep small assembly parts out of reach of children.

⚠ Use under adult supervision

OBSERVE ALL STATEMENTS AND WARNINGS TO REDUCE THE LIKELIHOOD OF SERIOUS OR FATAL INJURY. SAVE THIS SHEET FOR FUTURE REFERENCE.

OPERATION INSTRUCTIONS

1. An adult should always supervise use of this product by children of all ages.
2. Instruct children not to attach items to the playground equipment that are not specifically designed for use with the equipment (examples: ropes, clothesline, pet leashes, cables and chain, etc) as they may cause a strangulation hazard or any other hazard.
3. Never allow children to use the equipment in a manner other than intended.

MAINTENANCE INSTRUCTIONS

1. Inspect the product periodically for loose or damaged components. **Tighten bolts if need.**
2. Check all connections and bolts for tightness at least twice monthly during the usage.
3. Check all coverings and bolts for sharp edges.

INSTALLATION INSTRUCTIONS

Please have an electrical drill available for assembly if possible

If you have difficulty in installation, please contact us for help and get installation video for reference

Please Ensure:

1. You are assembling with at least two people to ensure that all sides and parts are leveled.
2. You don't screw the parts in too hard or it will splinter the wood.
3. You follow the directions carefully.

CONTACT US BEFORE ASSEMBLY

If you have assembly questions or if you need parts
whether they are missing or damaged

Call us at 888-697-3931 or email us at

info@Avenlur.com

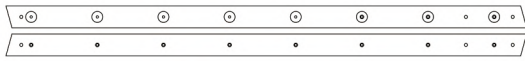

①x2 56.1in

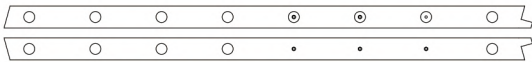

②x1 56.9in



③x1 56.9in

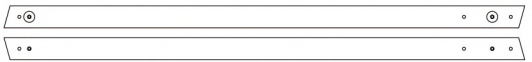

④x1 56.1in



⑤x3 36.3in



⑥x9 17.9in



⑦x4 54.1in



⑧x1 56.1in

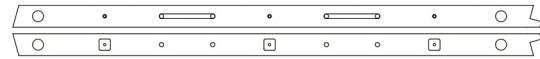

⑨x1 56.9in



⑩x1 56.9in

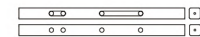

⑪x2 17.9in

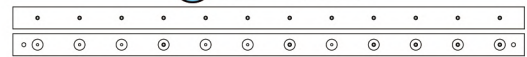

⑫x2 55.1in



⑬x12 15.6in



⑭x1

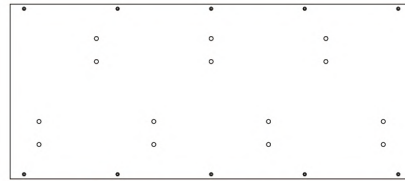

⑯x1 43.3in



⑰x7



⑮x2 47.2in

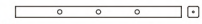

⑳x1 17.9in

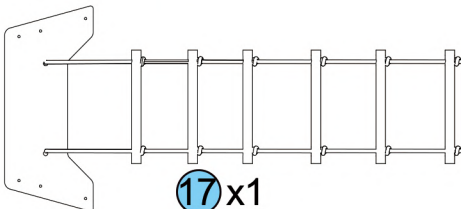

⑰x1

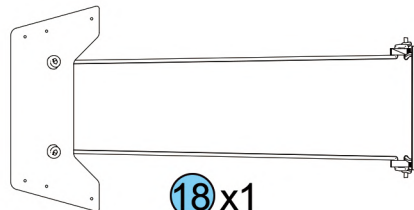

⑱x1



㉑x2 63in



㉒x1 165.4in



M6.3x40
①x62



M4x40
②x14



M4x30
③x8

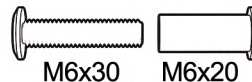

M6x30 M6x20
④x8

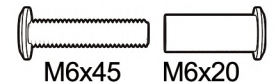

M6x45 M6x20
⑤x4

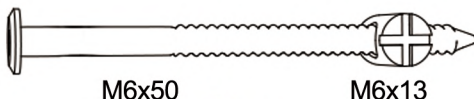

M6x50 M6x13
⑥x4

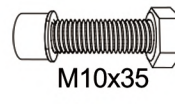

M10x35
⑦x14

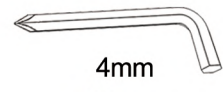

4mm
⑧x2

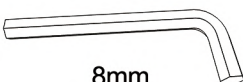

8mm
⑨x1





17mm
⑩x1

Section A

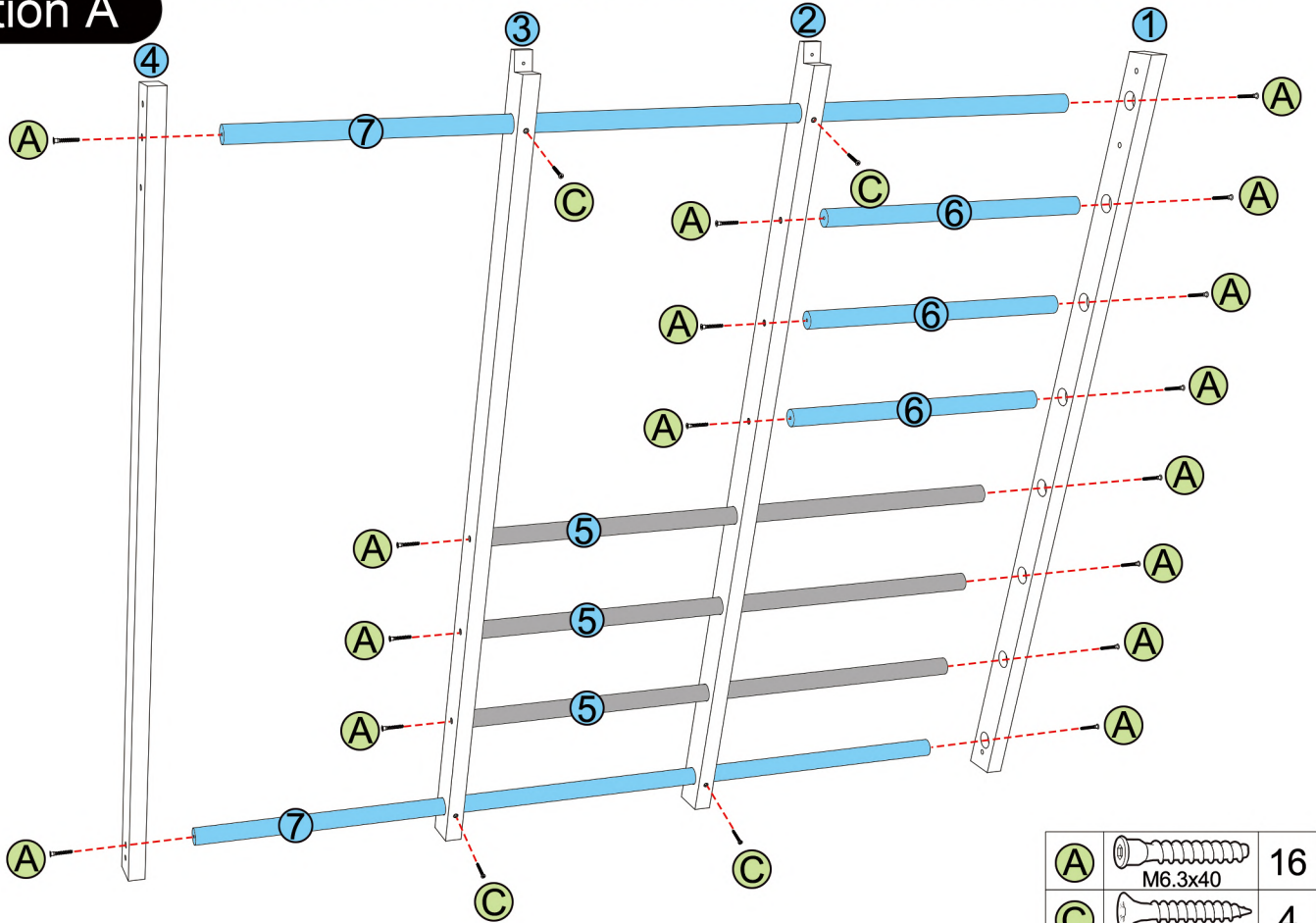
Tip: Align all the parts tight in their places before screwing them in

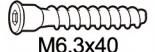

A		16
C		4

NOTE:

Part **5** (x3): Go through part **2**

Part **6** (x3): Sit between **1** & **2**

Part **7** (x2): Go through the ends of part **2** & **3**, ending of **1** & **4**

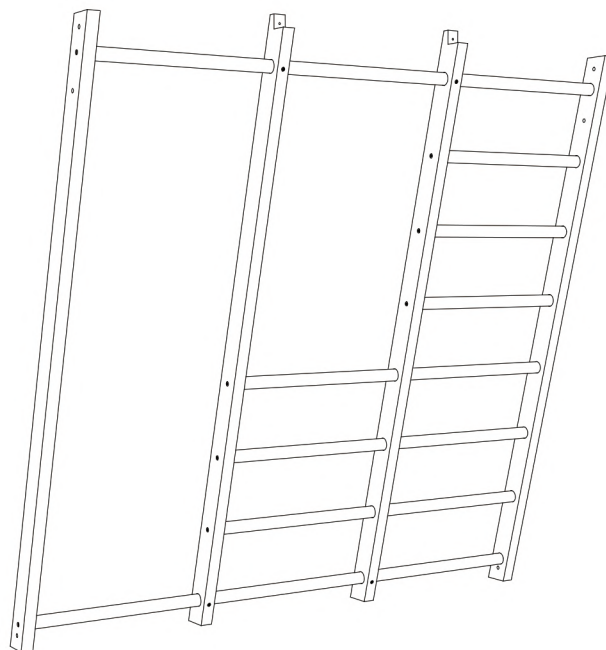

Section B

Tip: Align all the parts tight in their places before screwing them in

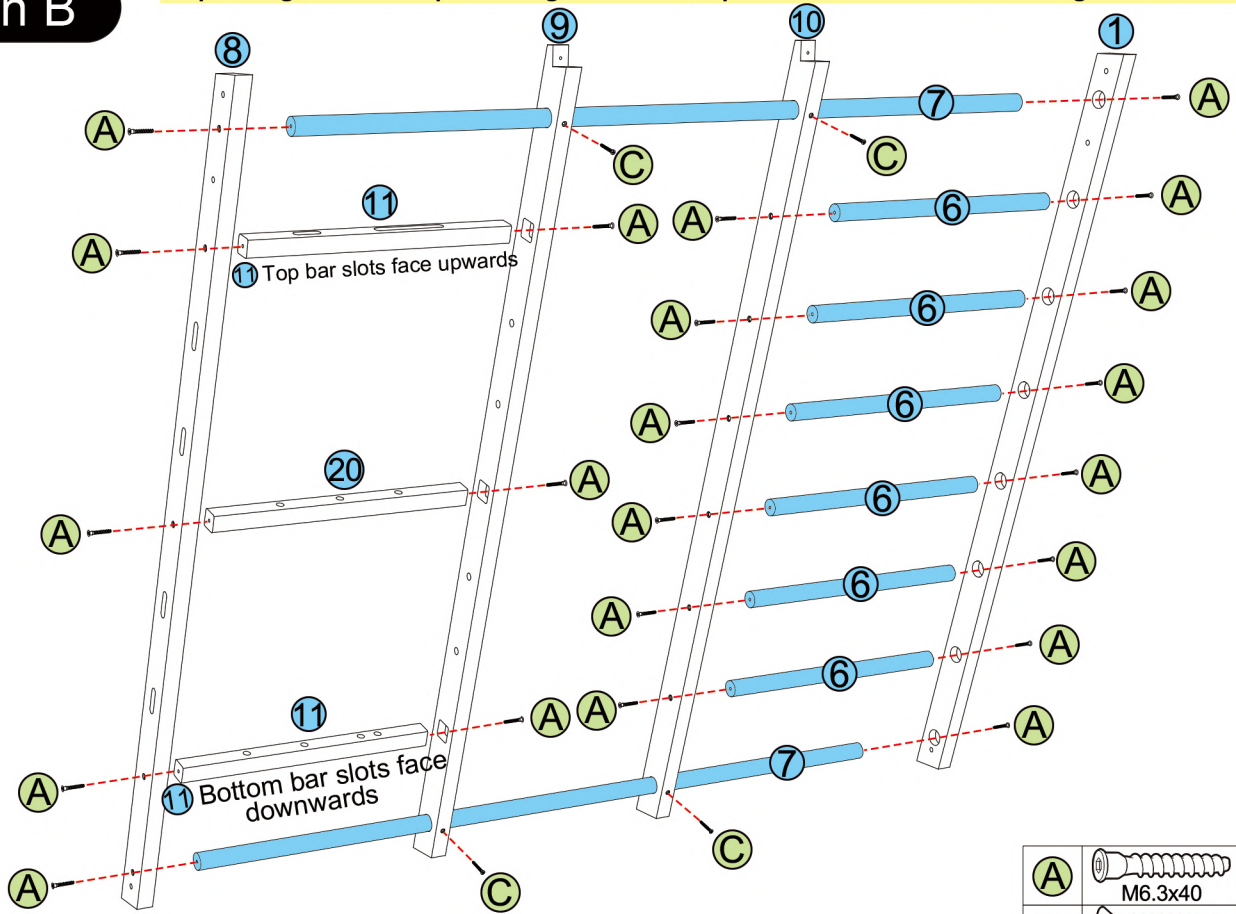

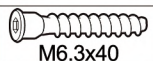
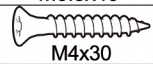
A		22
C		4

NOTE:



- Parts 7(x2): Go through the ends of part 9 & 10, ending of 1 & 8
- Parts 6(x6): Sit between 1 & 10
- Parts 11(x2): Sit between 8 & 9
- Part 20(x1): Sit between 8 & 9

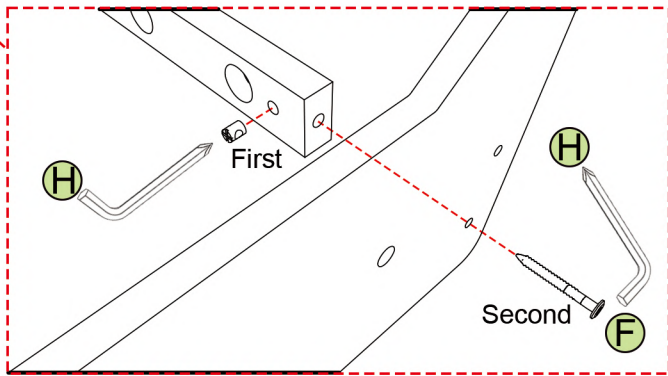
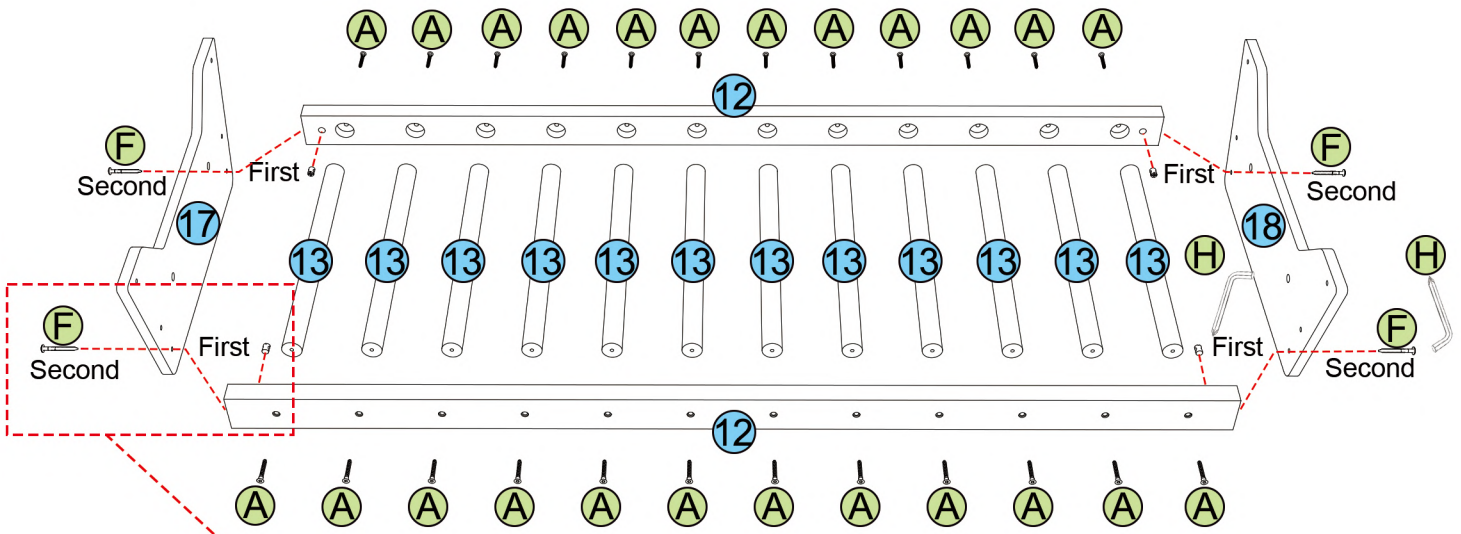

Section C

Tip: Align all the parts tight in their places before screwing them in

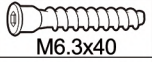
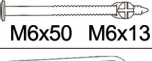

(A)	 M6.3x40	24
(F)	 M6x50 M6x13	4
(H)	 4mm	2

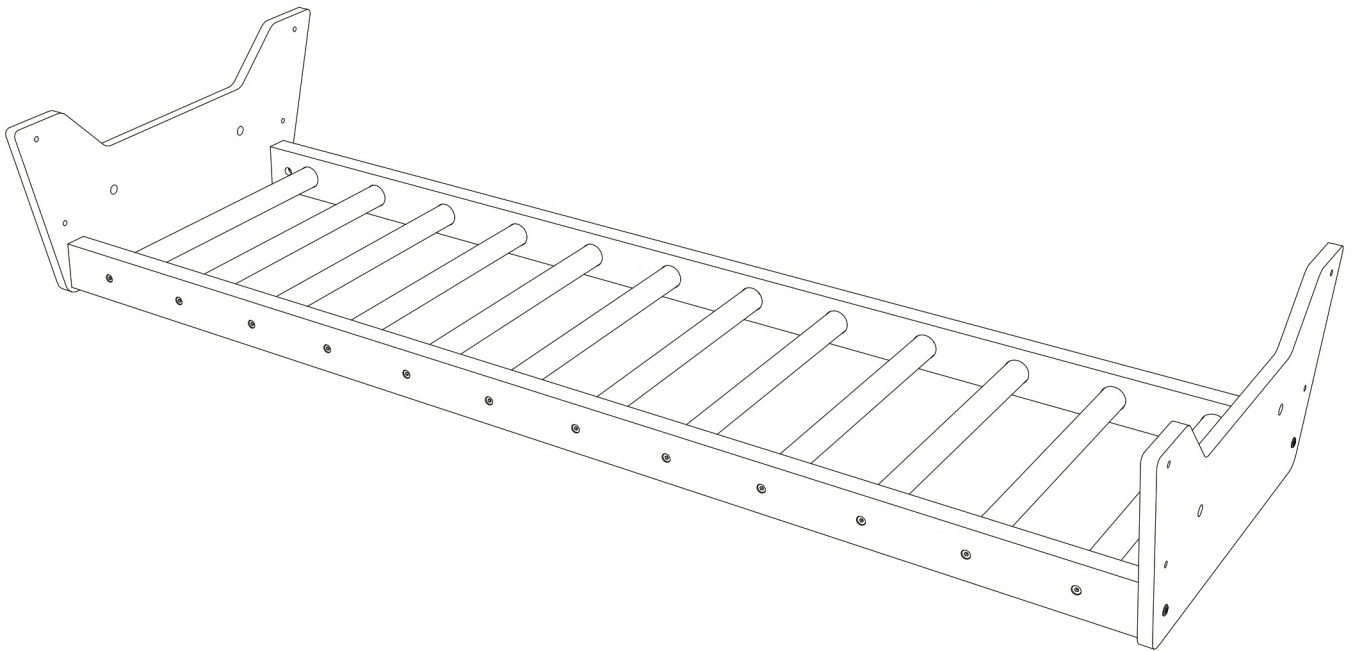

Section A

Section B

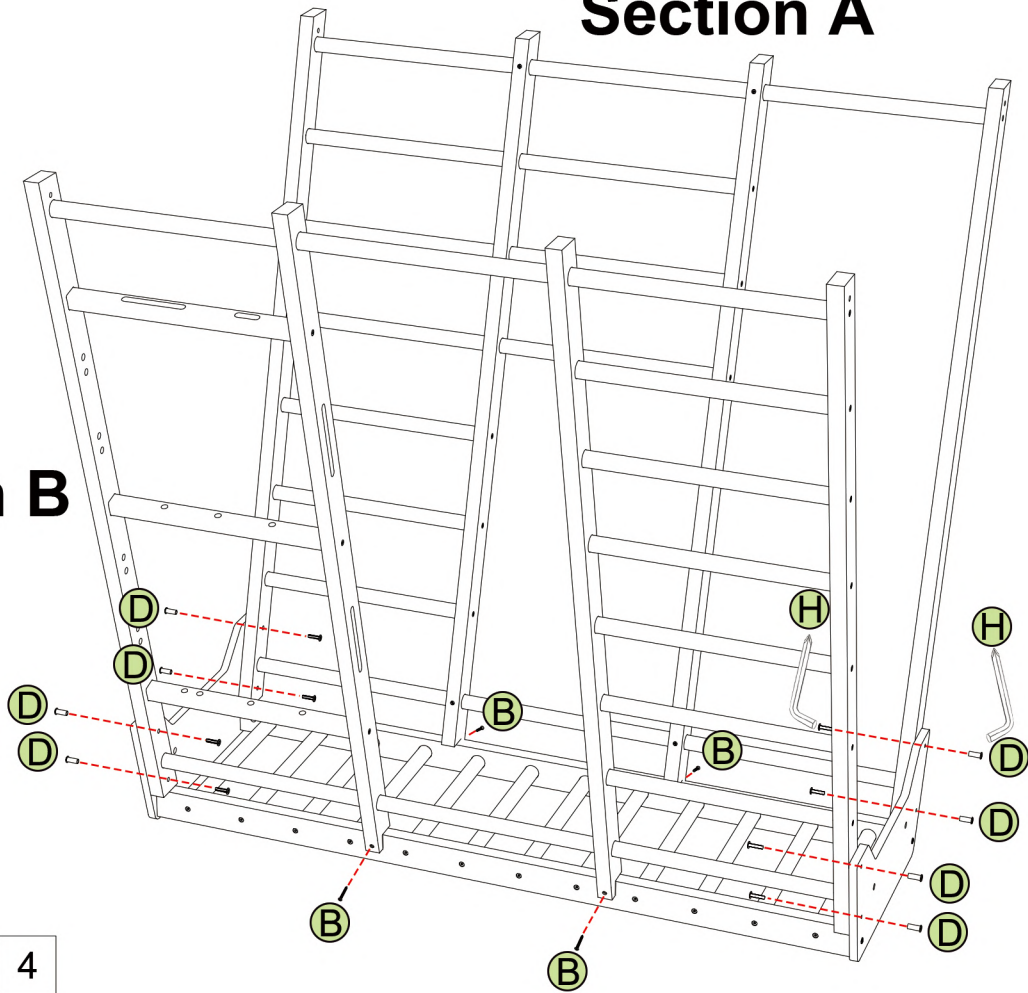



B		4
D		8
H		2

NOTE:

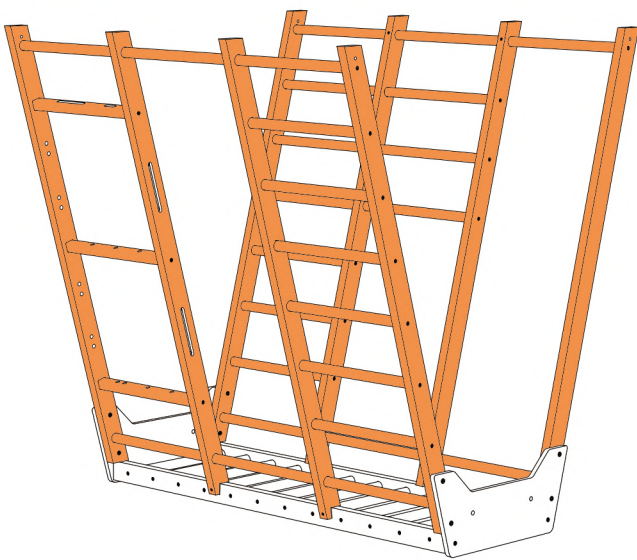
Attach section A & B to Parts 17 & 18 while upside down.
 Do not tighten screw **D** all the way until all screws are in place.
 It's helpful to have another person hold section A & B in place.

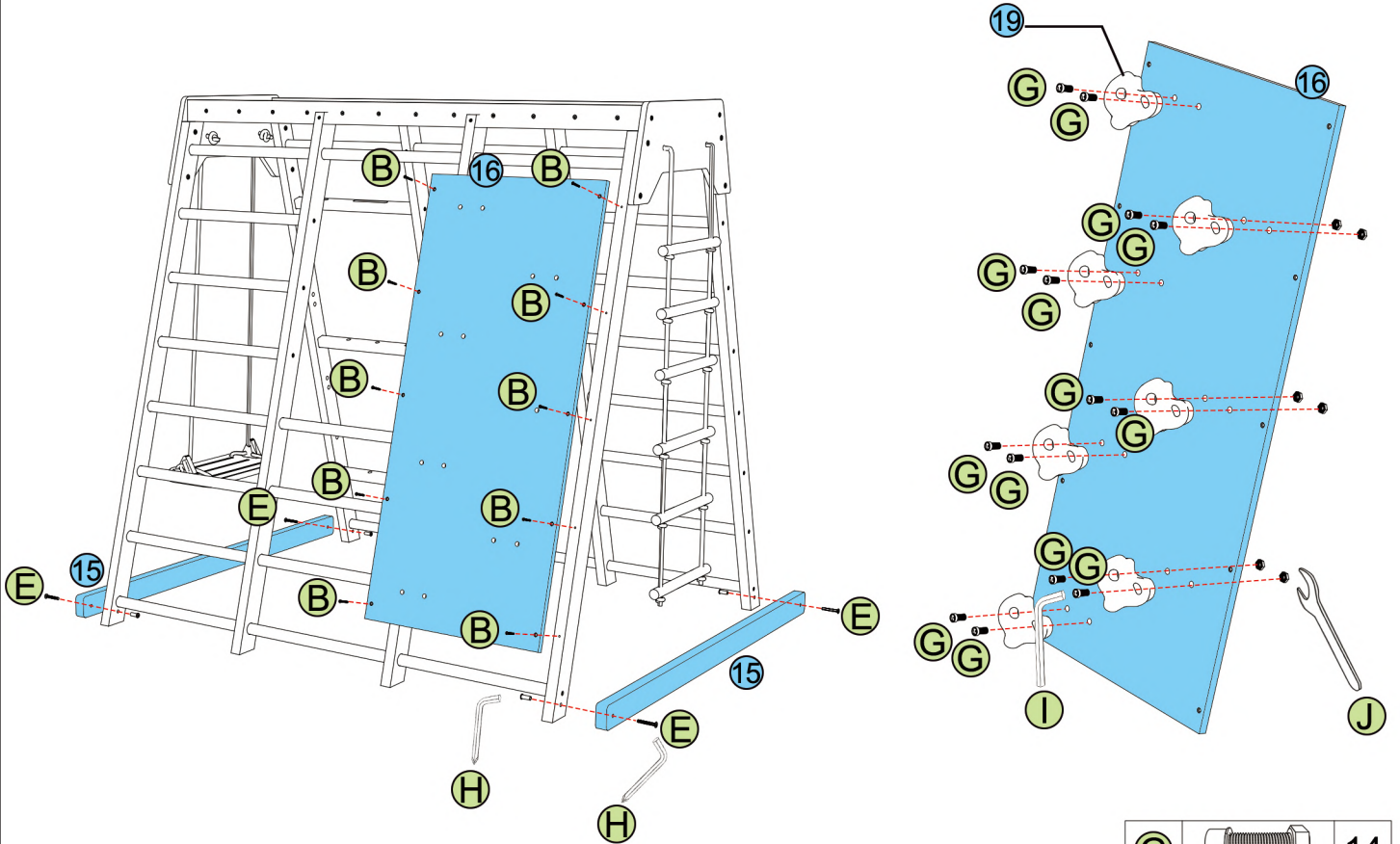



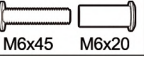
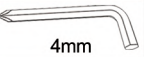

B	 M4x40	10
E	 M6x45 M6x20	4
H	 4mm	2

NOTE:

1. Turn the playset upright and attach Parts **15** to the base of Section A & B.
2. Attach board **16** to the set
3. Attach rocks **19** (x7) to the board

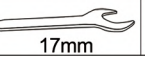
G	 M10x35	14
I	 8mm	1
J	 17mm	1

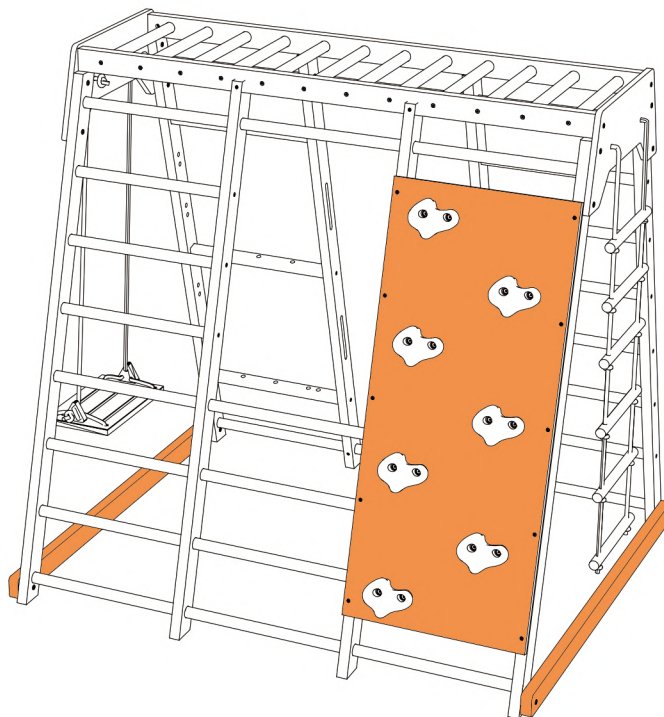

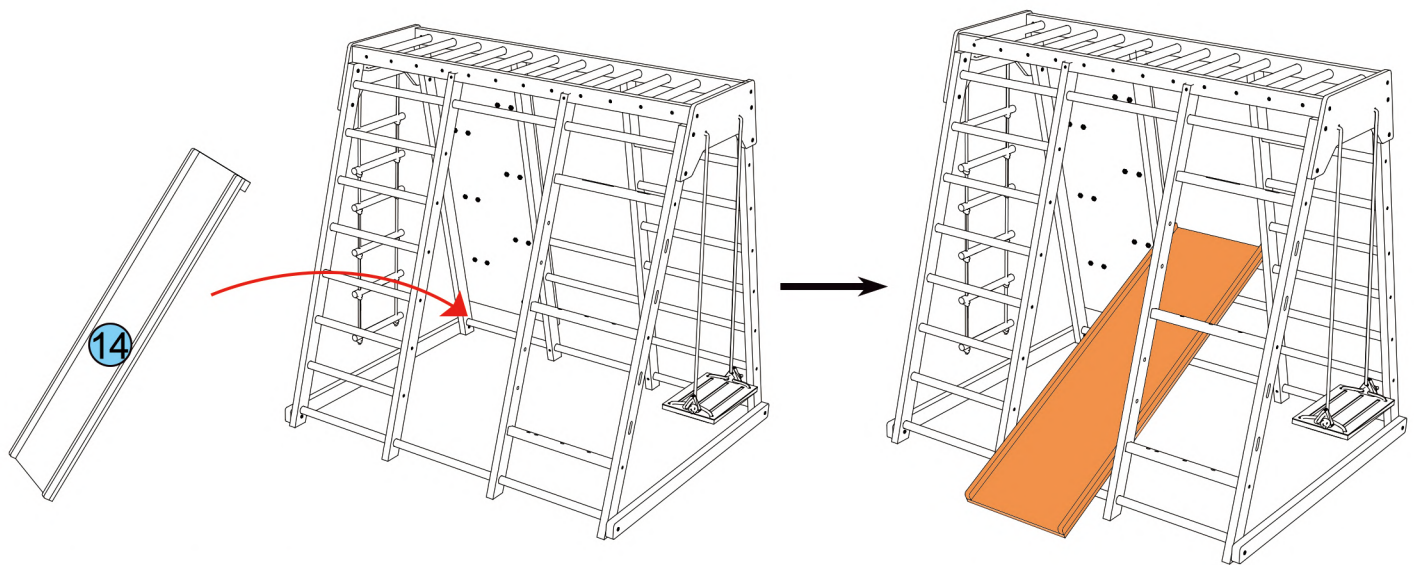

NOTE: The slide acts as a counterbalance for stability. Without it, the set may sway

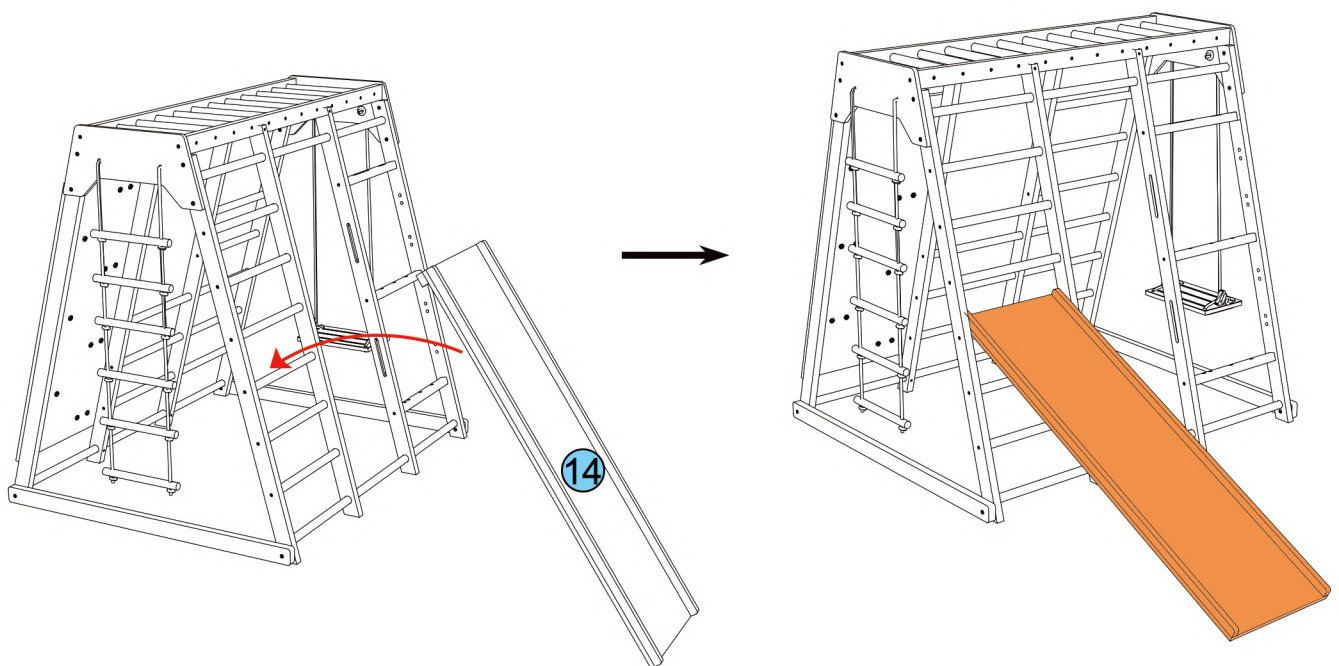

If larger children are on the swing, move the slide to the middle bar as shown to create more space. The set may sway a little, but that is normal.

Step 1

Step 2

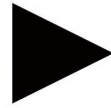
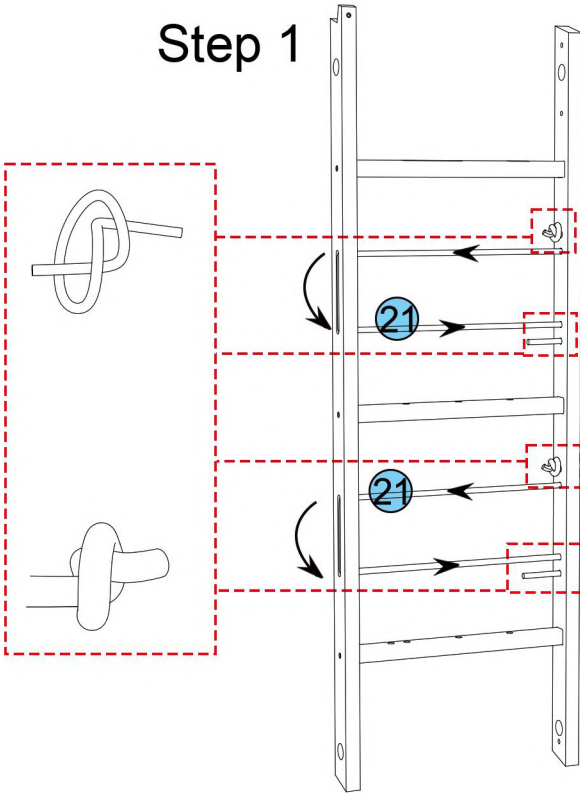

Note: The vertical rope will wrap once around each horizontal rope on each pass.
The vertical rope goes through the holes of the middle horizontal bar

Step 3

Step 4

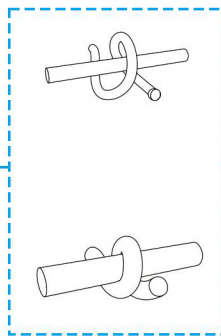
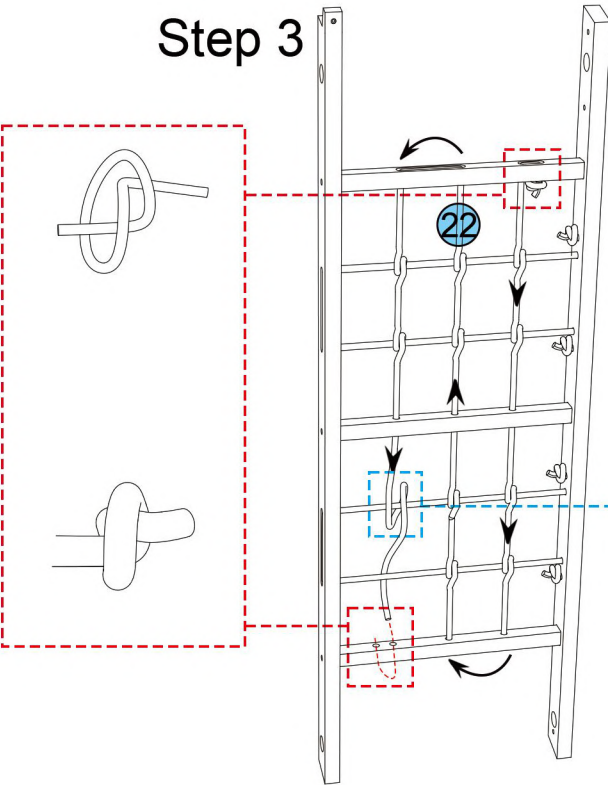

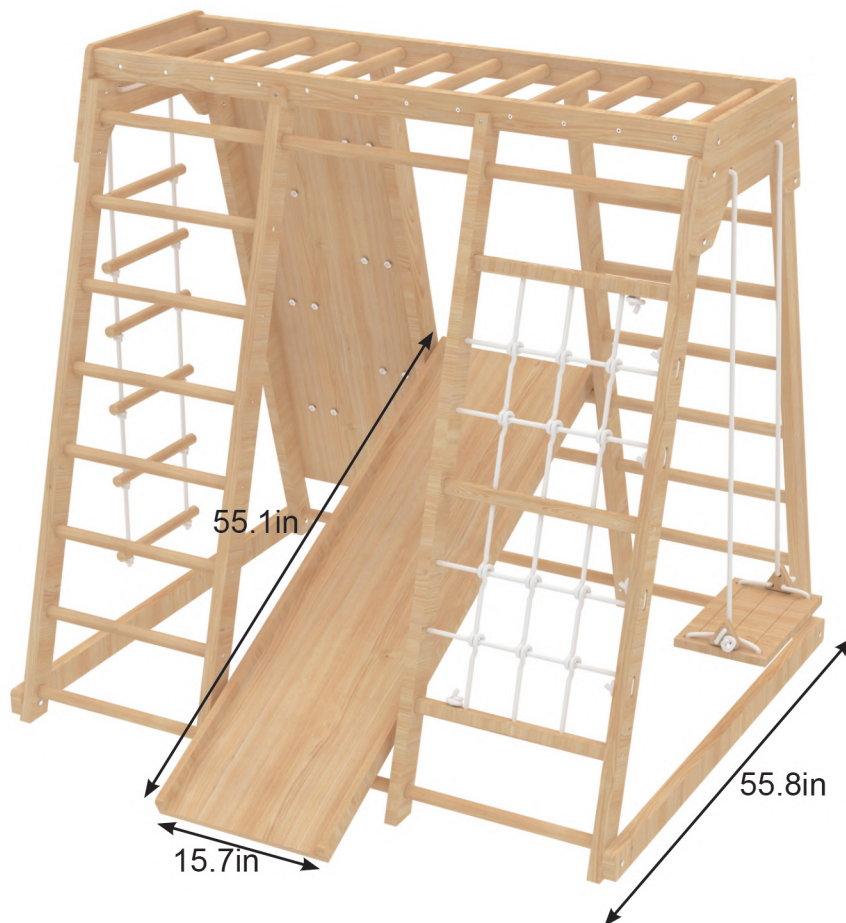
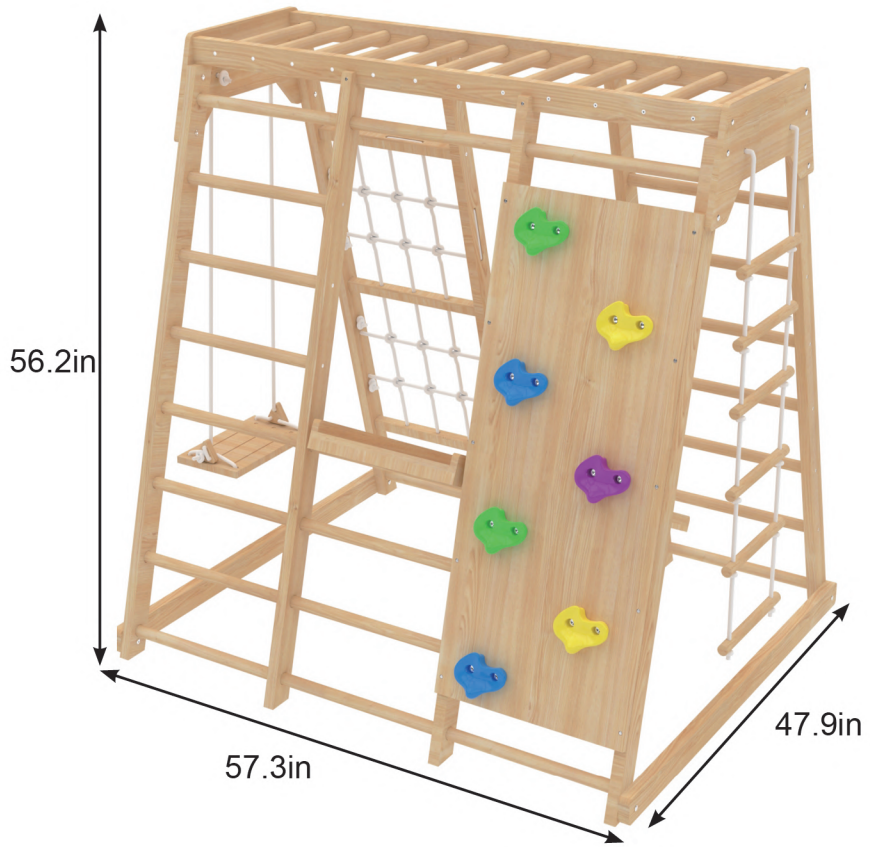



For questions with assembly or replacement parts, please email us at: info@avenlur.com or call us at: [888-697-3931](tel:888-697-3931)