

# avenlur

## Magnolia by Avenlur

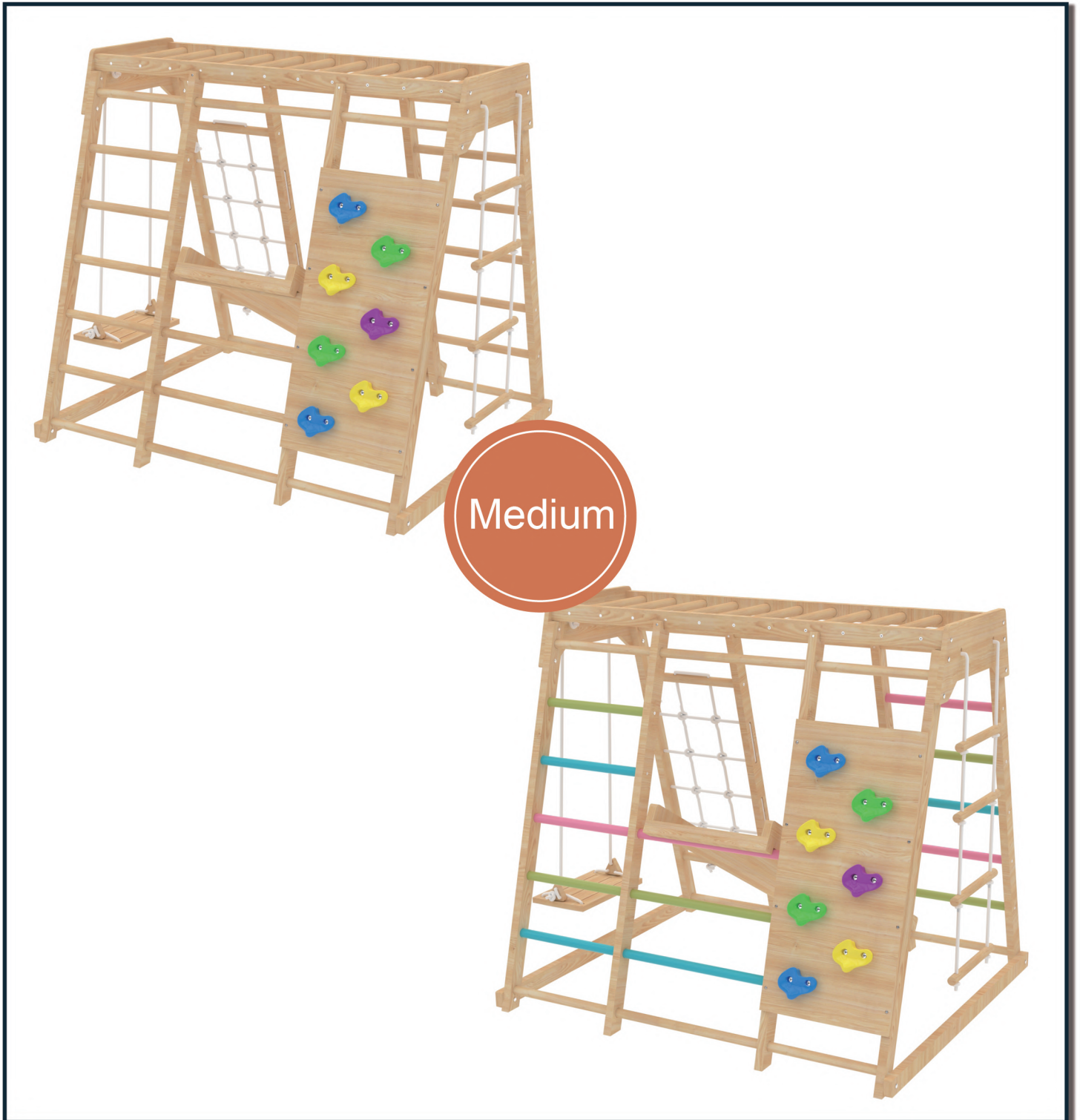

### Need Help?

CALL US AT 888.697.3931 / M-F 9AM - 5PM PT (12PM - -8PM ET)

OR EMAIL US AT [INFO@AVENLUR.COM](mailto:INFO@AVENLUR.COM)

V3S

**⚠ WARNING**

Adult assembly required.

**⚠ WARNING**

Maximum user weight: 110 lbs (50kg) per child

**⚠ WARNING**

**⚠ CHOKING HAZARD:**

Adult assembly required. Keep small assembly parts out of reach of children.

**⚠ Use under adult supervision**

**OBSERVE ALL STATEMENTS AND WARNINGS TO REDUCE THE LIKELIHOOD OF SERIOUS OR FATAL INJURY. SAVE THIS SHEET FOR FUTURE REFERENCE.**

**OPERATION INSTRUCTIONS**

1. An adult should always supervise use of this product by children of all ages.
2. Instruct children not to attach items to the playground equipment that are not specifically designed for use with the equipment (examples: ropes, clothesline, pet leashes, cables and chain, etc) as they may cause a strangulation hazard or any other hazard.
3. Never allow children to use the equipment in a manner other than intended.

**MAINTENANCE INSTRUCTIONS**

1. Inspect the product periodically for loose or damaged components. **Tighten bolts if need.**
2. Check all connections and bolts for tightness at least twice monthly during the usage.
3. Check all coverings and bolts for sharp edges.

**INSTALLATION INSTRUCTIONS**

Please have an electrical drill available for assembly if possible

If you have difficulty in installation, please contact us for help and get installation video for reference

**Please Ensure:**

1. You are assembling with at least two people to ensure that all sides and parts are leveled.
2. You don't screw the parts in too hard or it will splinter the wood.
3. You follow the directions carefully.

**CONTACT US BEFORE ASSEMBLY**

If you have assembly questions or if you need parts  
whether they are missing or damaged

Call us at 888-697-3931 or email us at

[info@Avenlur.com](mailto:info@Avenlur.com)



①x2  
46.9in



②x1  
48.1in



③x1  
48.1in



④x1  
46.9in



⑤x3 34.1in



⑥x7 14.9in



⑦x4 48.8in

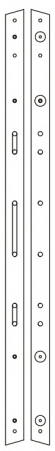

⑧x1  
46.9in



⑨x1  
48.1in



⑩x1  
48.1in

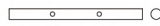

⑪x2 14.9in



⑫x2 49.6in



⑬x11 15.6in

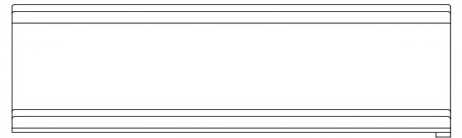

⑭x1 47.2in



⑮x2 42.5in

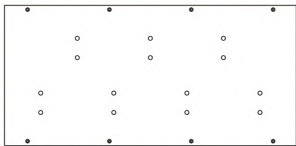

⑯x1 31.4in

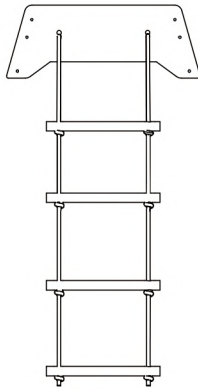

⑰x1

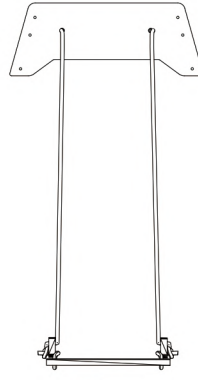

⑱x1



⑲x7



⑳x2  
94.5in



M6.3x40  
A x54

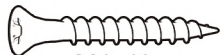

M4x40  
B x12



M4x30  
C x8

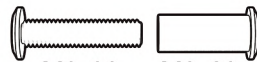

M6x30 M6x20  
D x8



M6x40 M6x20  
E x4

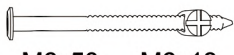

M6x50 M6x13  
F x4



M10x35  
G x14



4mm  
H x2

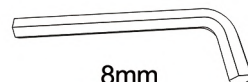

8mm  
I x1



17mm  
J x1



# Section A

Tip: Align all the parts tight in their places before screwing them in

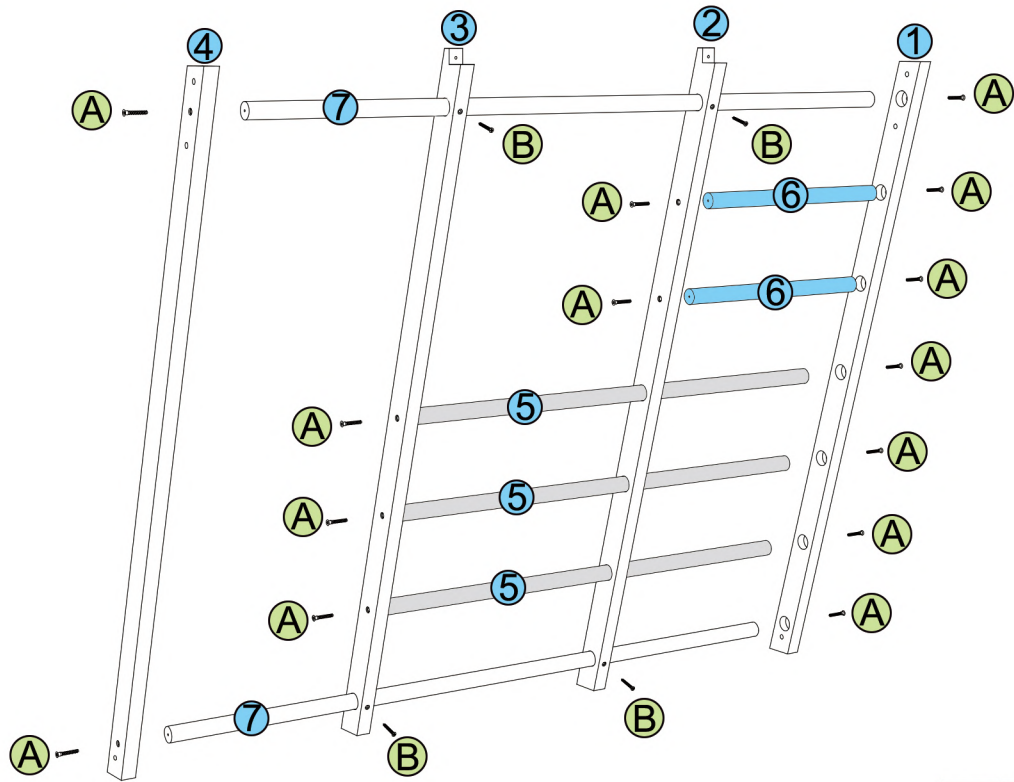

NOTE:

Part 5(x3): Go through part 2

Part 6(x2): Sit between 1&2

Part 7(x2): Go through the ends of part 2&3, ending of 1&4

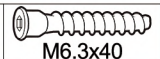
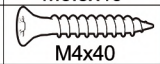

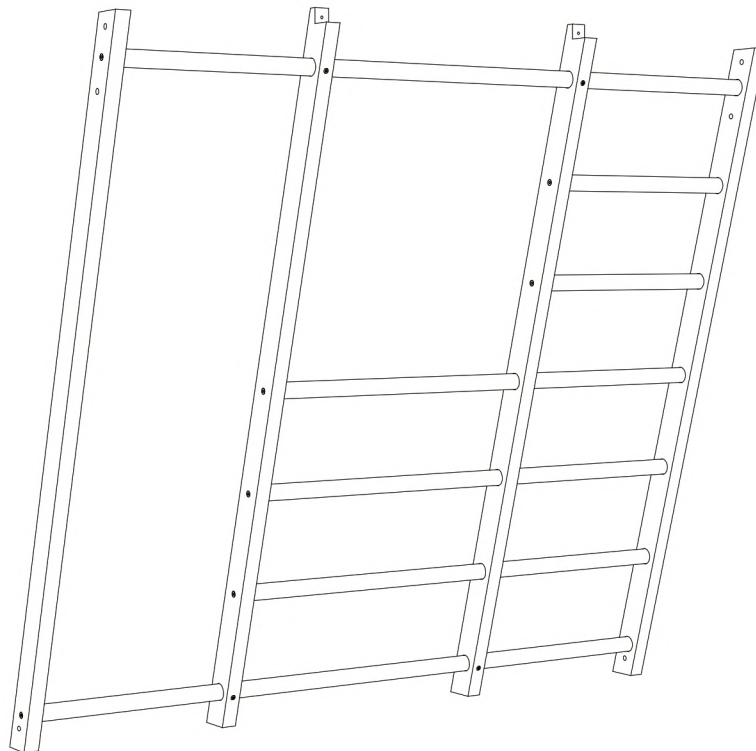
A	 M6.3x40	14
B	 M4x40	4

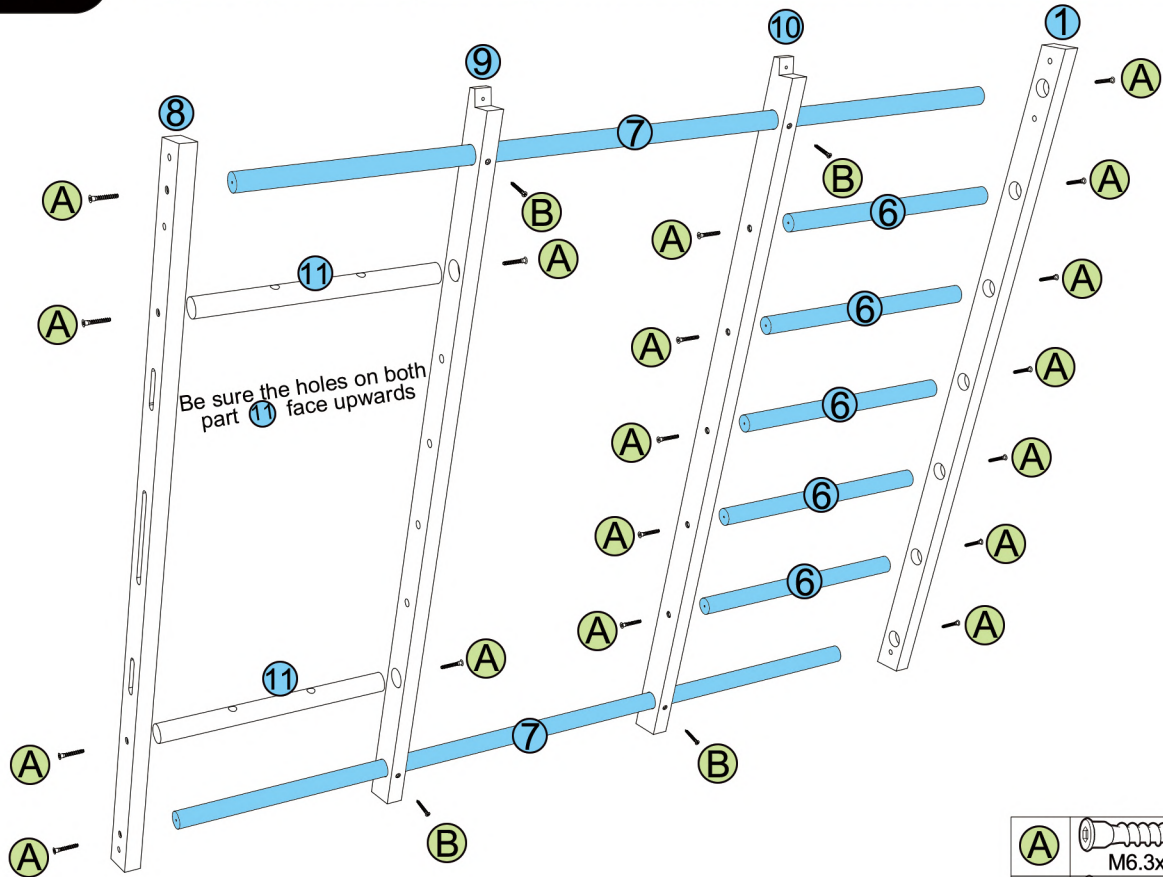

# Section B

Tip: Align all the parts tight in their places before screwing them in



A		18
B		4

**NOTE:**

Parts 7 (x2): Go through the ends of part 9 & 10, ending of 1 & 8

Parts 6 (x5): Sit between 1 & 10

Parts 11 (x2): Sit between 8 & 9

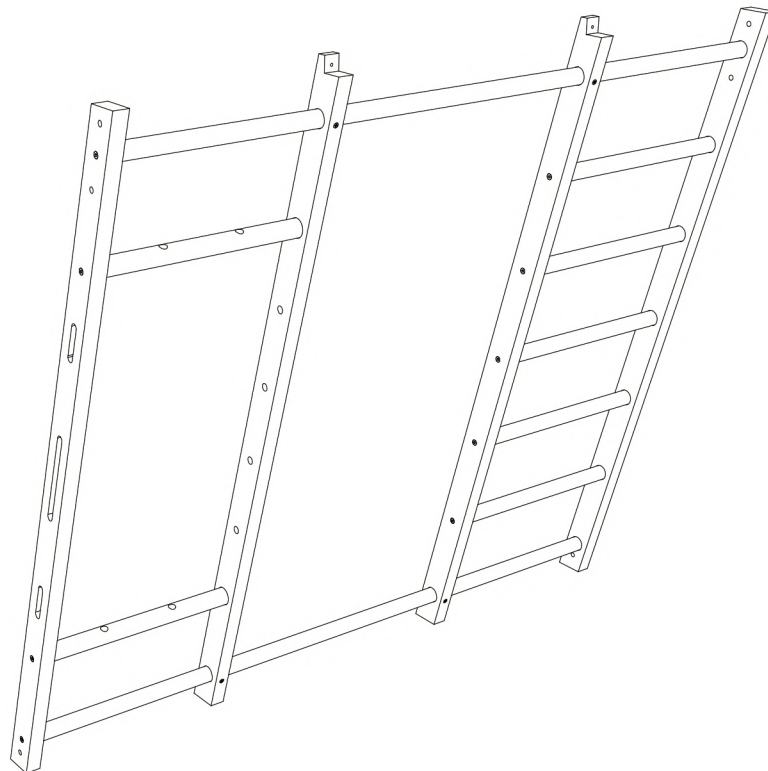

# Section C

Tip: Align all the parts tight in their places before screwing them in

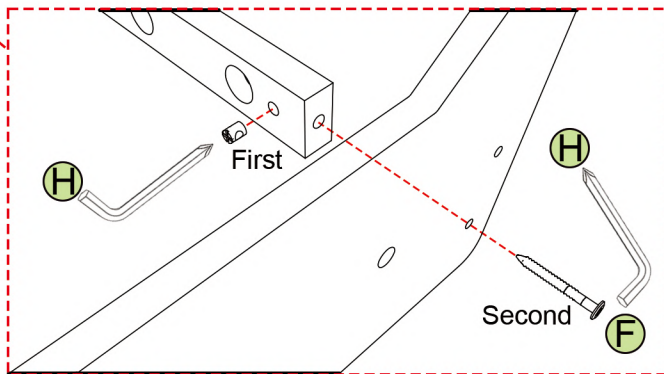
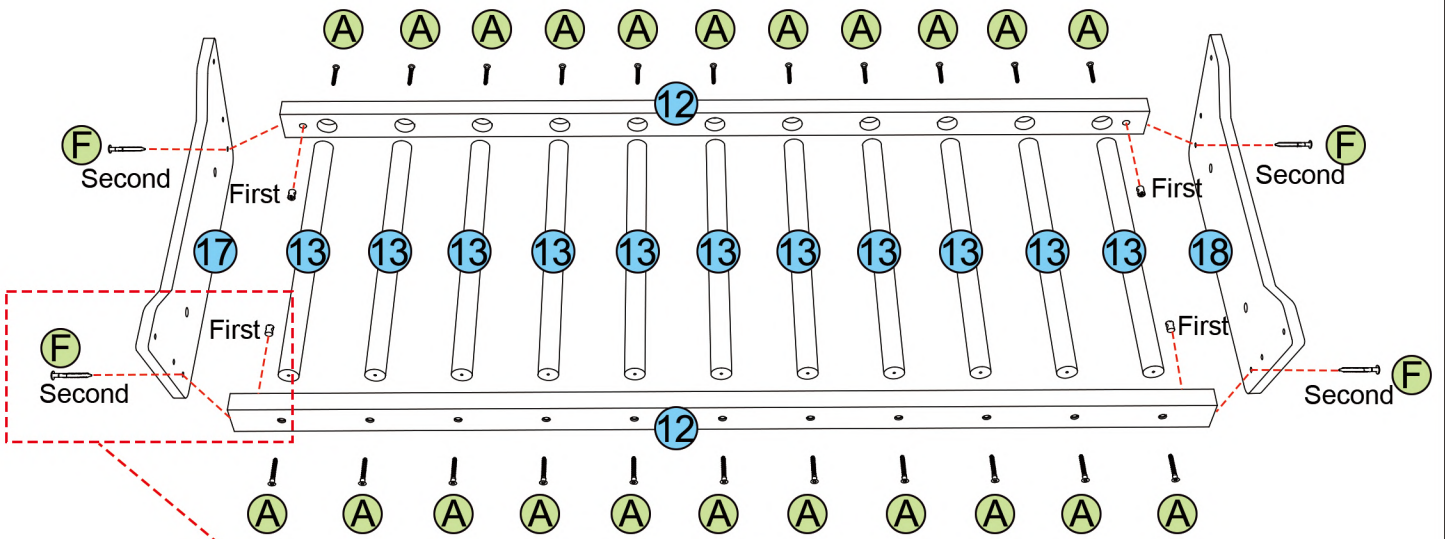

<b>A</b>		22
<b>F</b>		4
<b>H</b>		2

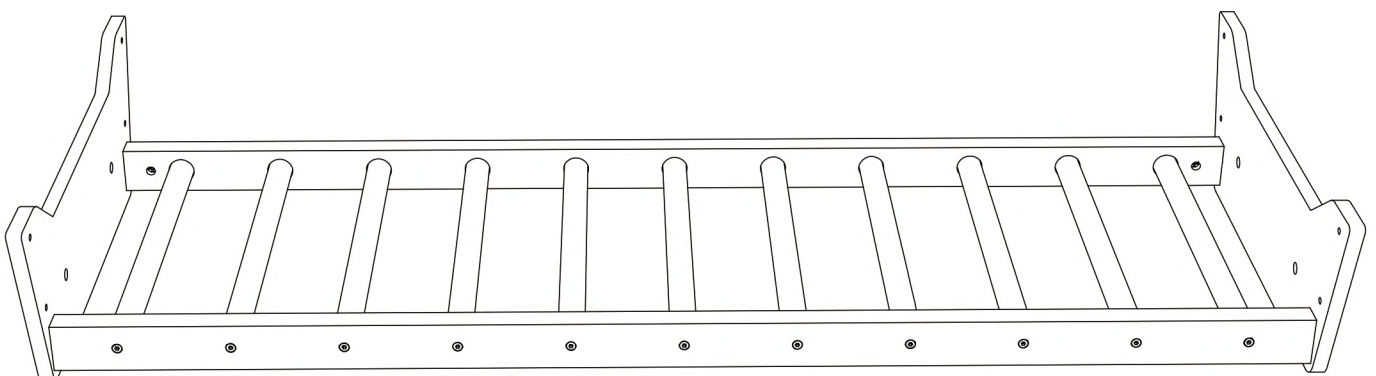



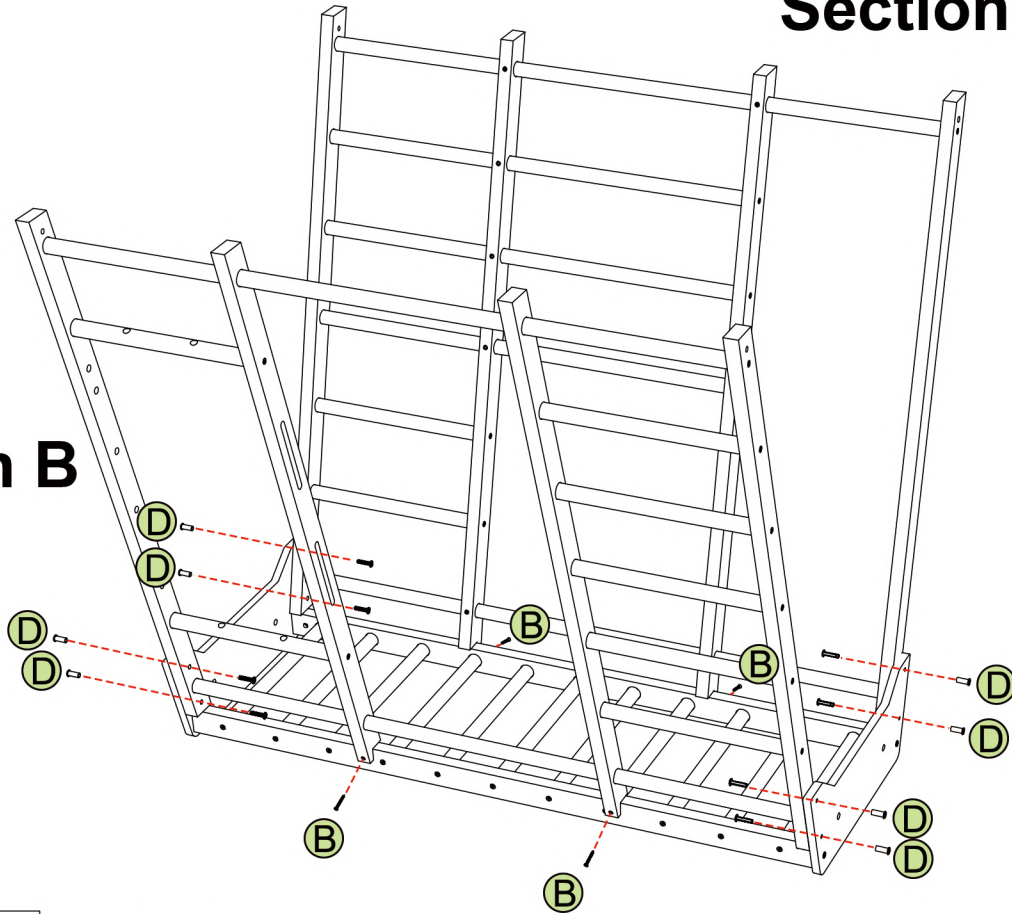

# Section A

# Section B

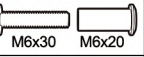

<b>B</b>	 M4x40	4
<b>D</b>	 M6x30 M6x20	8
<b>H</b>	 4mm	2

**NOTE:**



Attach section A & B to Parts **17** & **18** while upside down.

Do not tighten screw **D** all the way until all screws are in place.

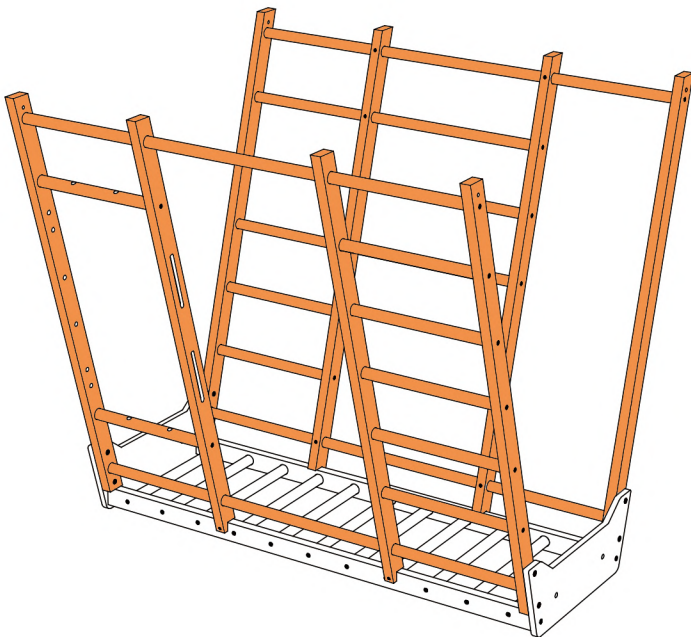
It's helpful to have another person hold section A & B in place.

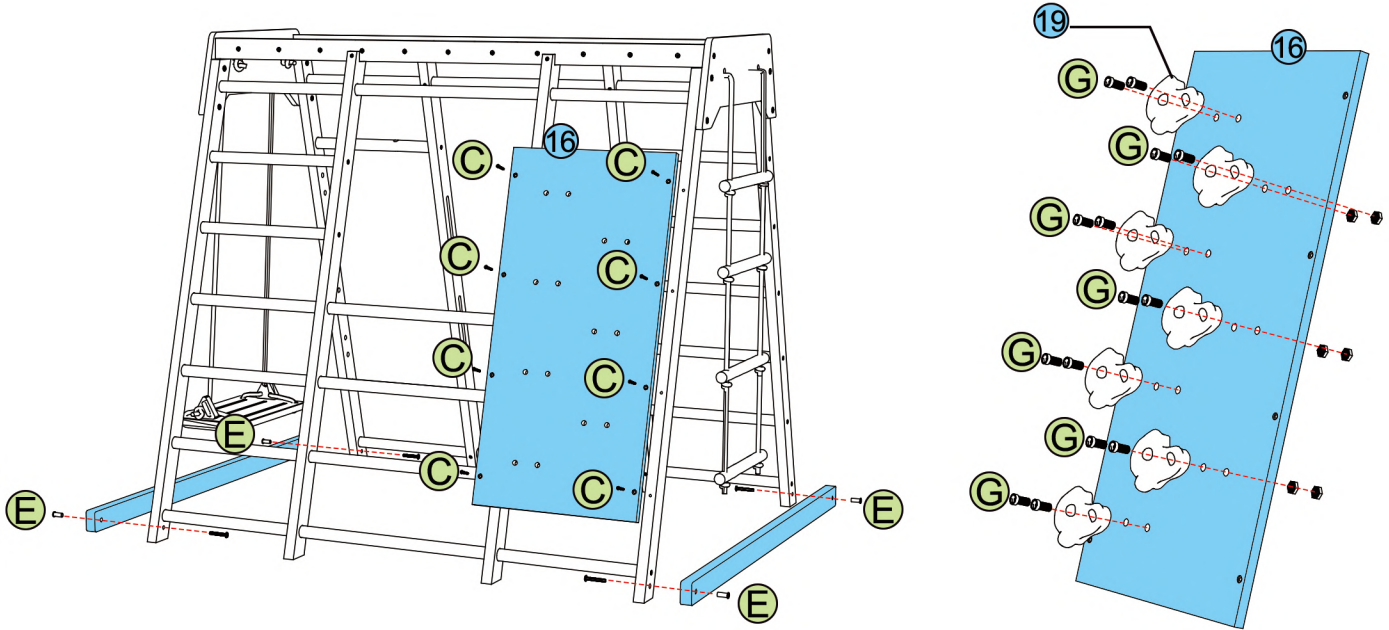

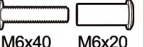



<b>C</b>	 M4x30	8
<b>E</b>	 M6x40 M6x20	4
<b>H</b>	 4mm	2

**NOTE:**

1. Turn the playset upright and attach Parts 15 to the base of Section A & B.
2. Attach board 16 to the set
3. Attach rocks 19 (x7) to the board

<b>G</b>	 M10x35	14
<b>I</b>	 8mm	1
<b>J</b>	 17mm	1

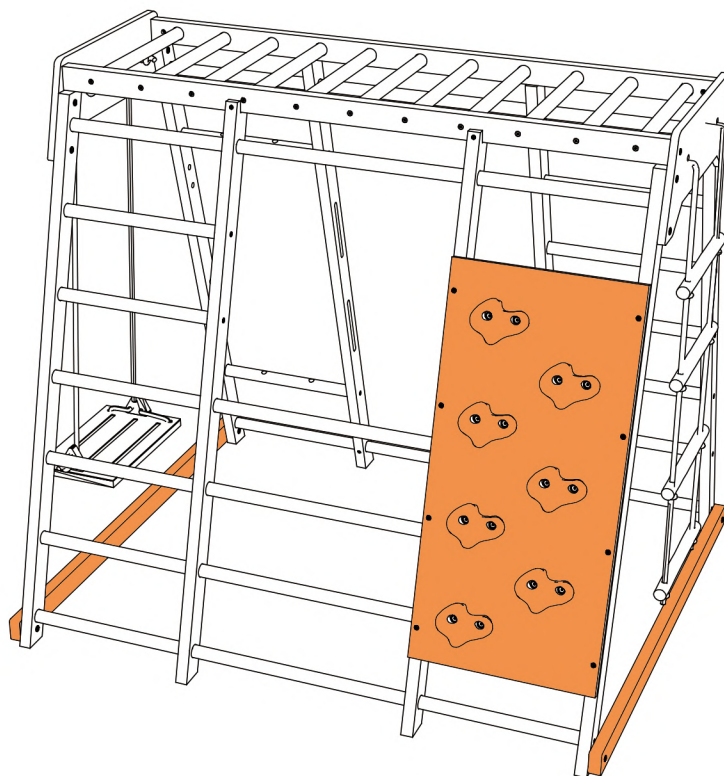



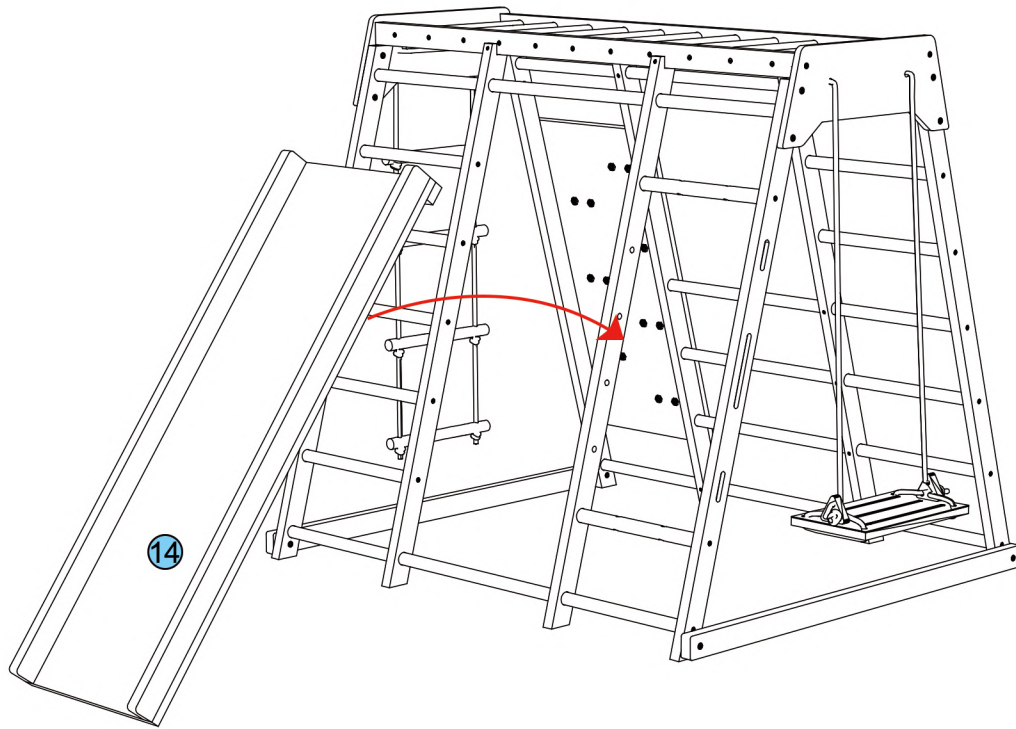

NOTE: The slide acts as a counterbalance for stability. Without it, the set may sway

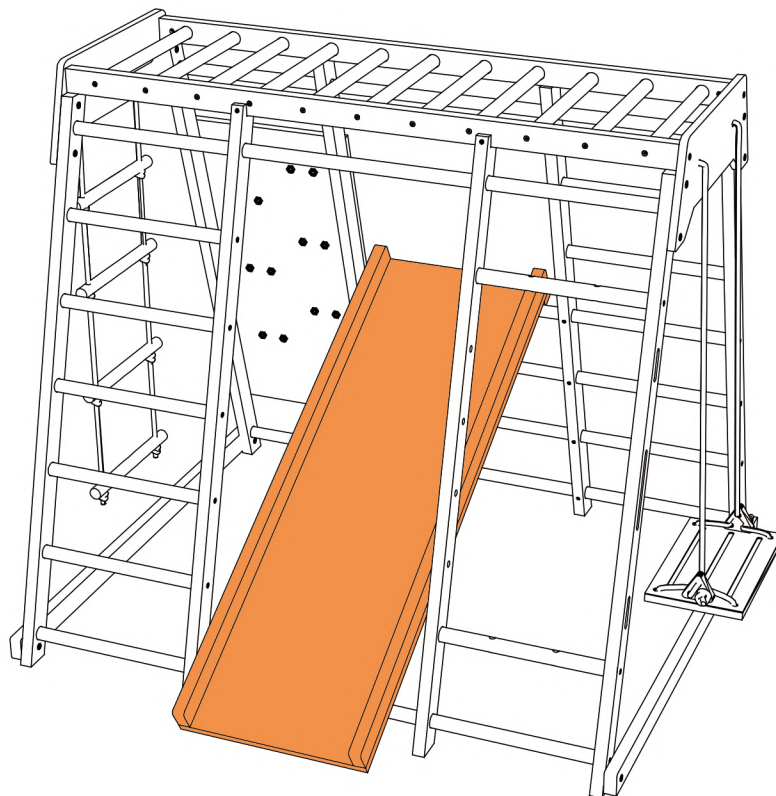

Step 1

Step 2

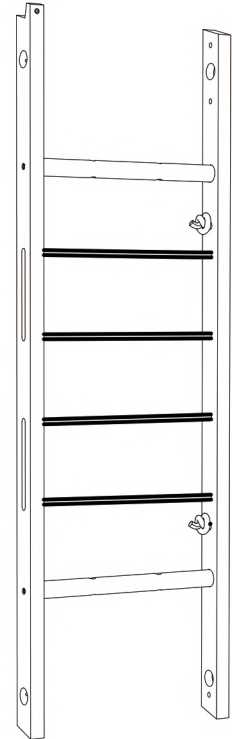
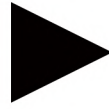
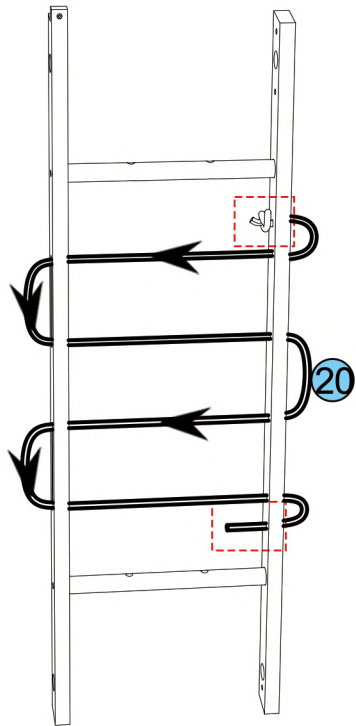
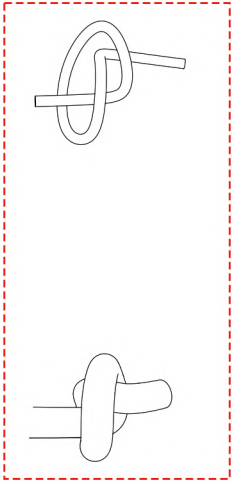

Note: The vertical rope will wrap once around each horizontal rope on each pass.  
The vertical rope goes through the holes of the middle horizontal bar

Step 3

Step 4

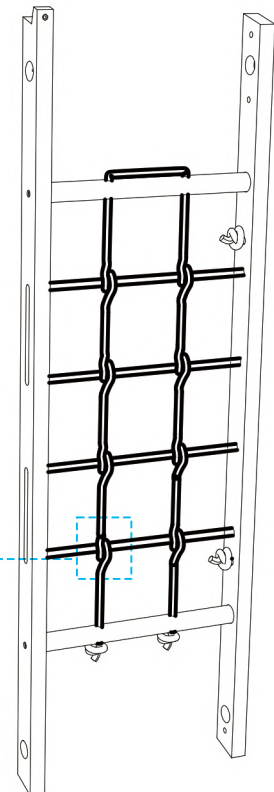
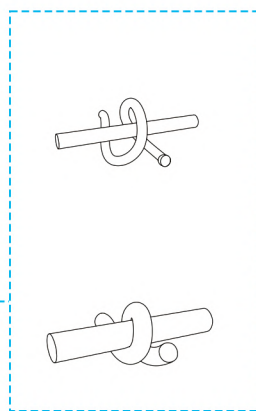
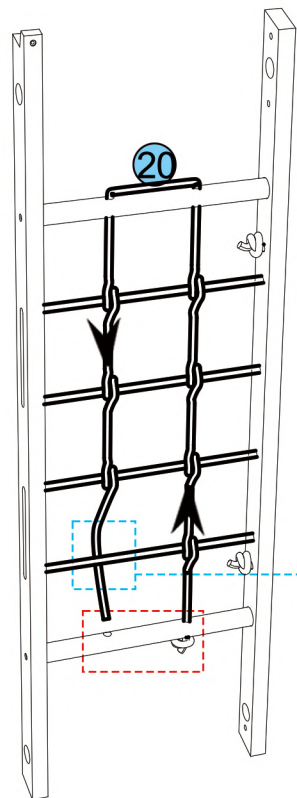
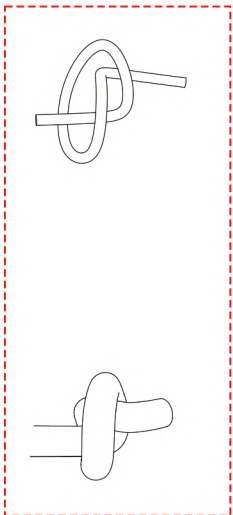





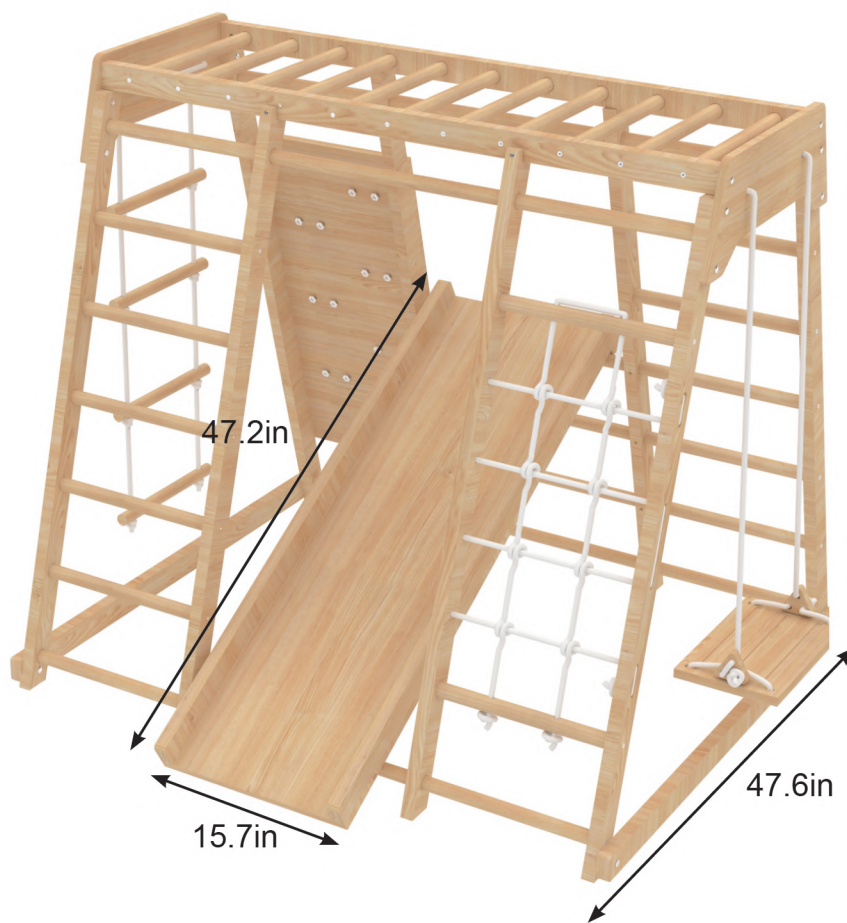
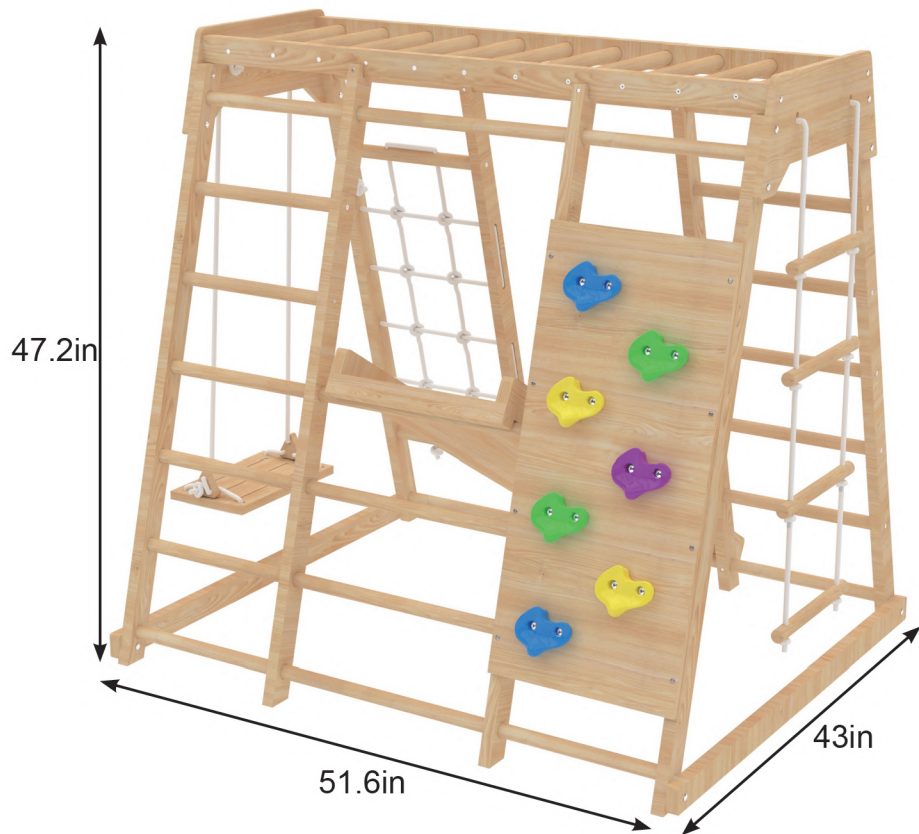

For questions with assembly or replacement parts, please email us at: [info@avenlur.com](mailto:info@avenlur.com) or call us at: **888-697-3931**