

avenlur

Spruce by Avenlur



Need Help?

CALL US AT 888.697.3931 / M-F 9AM - 5PM PT (12PM - -8PM ET)

OR EMAIL US AT INFO@AVENLUR.COM

V4

WARNING

Adult assembly required.

WARNING

Maximum user weight: 55 lbs (25kg) per child.

WARNING

CHOKING HAZARD:

Adult assembly required. Keep small assembly parts out of reach of children.

 Use under adult supervision.

OBSERVE ALL STATEMENTS AND WARNINGS TO REDUCE THE LIKELIHOOD OF SERIOUS OR FATAL INJURY. SAVE THIS SHEET FOR FUTURE REFERENCE.

OPERATION INSTRUCTIONS

1. An adult should always supervise use of this product by children of all ages.
2. Maximum weight per user: 55 lbs (25kg)
3. Instruct children not to attach items to the playground equipment that are not specifically designed for use with the equipment (examples: ropes, clothesline, pet leashes, cables and chain, etc) as they may cause a strangulation hazard or any other hazard.
4. Never allow children to use the equipment in a manner other than intended.

MAINTENANCE INSTRUCTIONS

1. Inspect the product periodically for loose or damaged components. **Tighten bolts if need.**
2. Check all connections and bolts for tightness at least twice monthly during the usage.
3. Check all coverings and bolts for sharp edges.

INSTALLATION INSTRUCTIONS

Please have an electrical drill available for assembly if possible.

If you have difficulty in installation, please contact us for help and get installation video for reference.

Please Ensure:

1. You are assembling with at least two people to ensure that all sides and parts are leveled.
2. You don't screw the parts in too hard or it will splinter the wood.
3. You follow the directions carefully.

CONTACT US BEFORE ASSEMBLY

If you have assembly questions or if you need parts
whether they are missing or damaged

Call us at 888-697-3931 or email us at

info@Avenlur.com

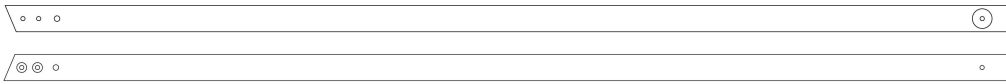

①x1 60.2in



②x1 60.2in

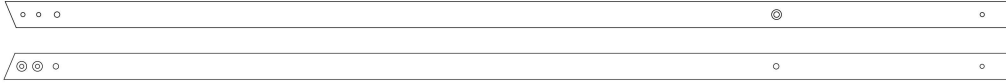

③x1 60.2in



④x1 60.2in



⑤x1 34.9in



⑥x1 37.1in

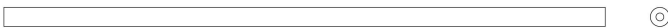

⑦x1 36.1in



⑧x2 45.3in

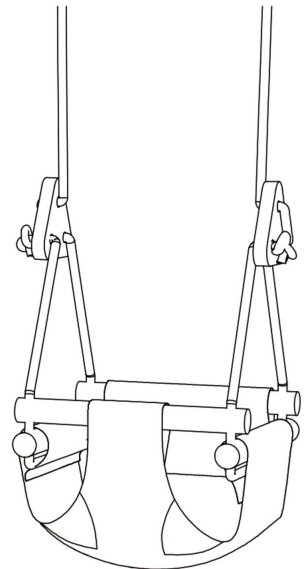

⑨x1



⑩ x4

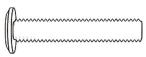

M6x60

Ⓐx2

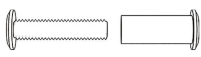

M6x45 M6x20

Ⓑx2

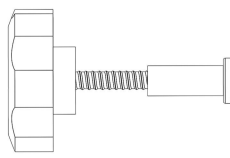

M6x45 M6x20

Ⓒx2

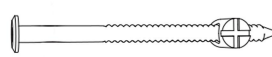

M6x60 M6x13

Ⓓx8

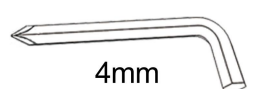

4mm

Ⓔx2

01-1

Note: Pay attention to all the black bubbled section markers. The manual may refer back to those later

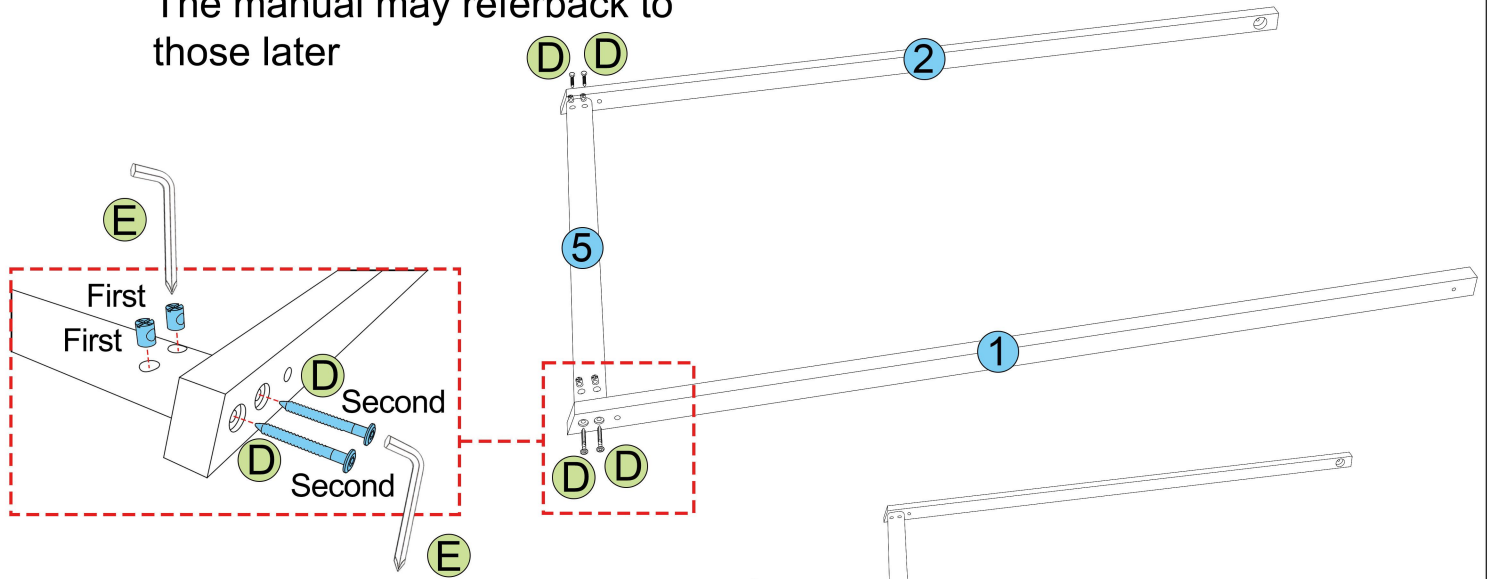

First: Put the connector in the hole with the crosshairs facing out. Use the Philips screwdriver side of one tool part **E** to hold the connector stationary for the threading of the screw go in.
 Second: Use the hex side of the other tool part **E** to thread the screw into the hole of the connector.

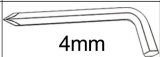
D	 M6x60 M6x13	4
E	 4mm	2

02-1

Important: Do not mix up part 5 and 6. They are different lengths

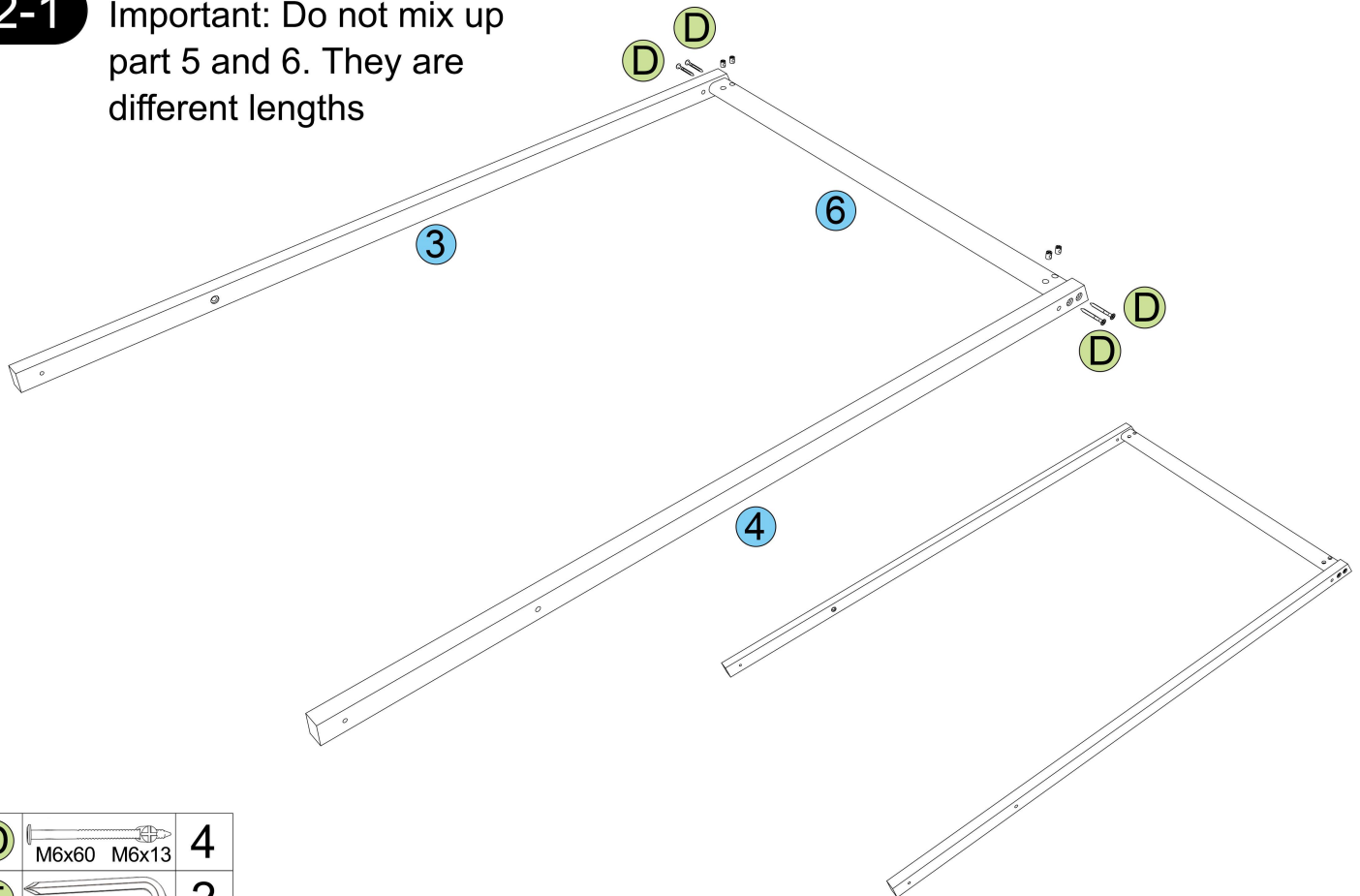

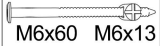
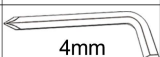

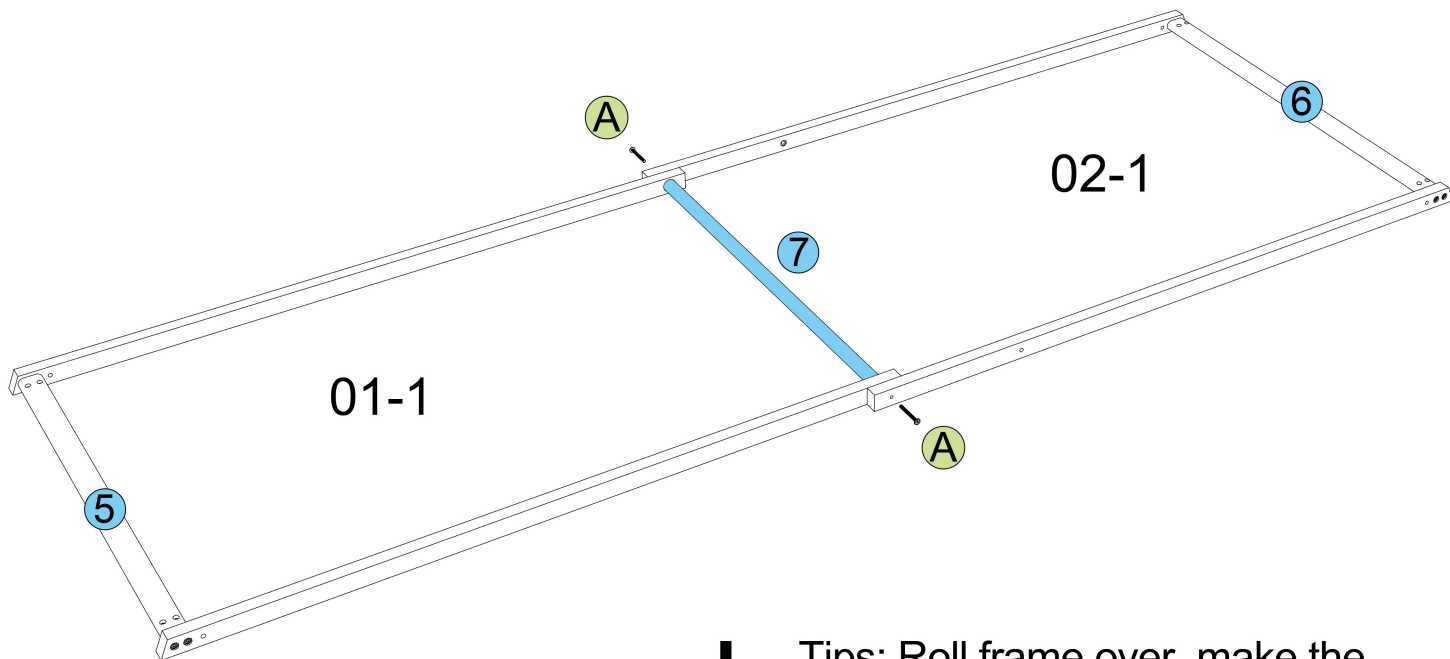
D	 M6x60 M6x13	4
E	 4mm	2

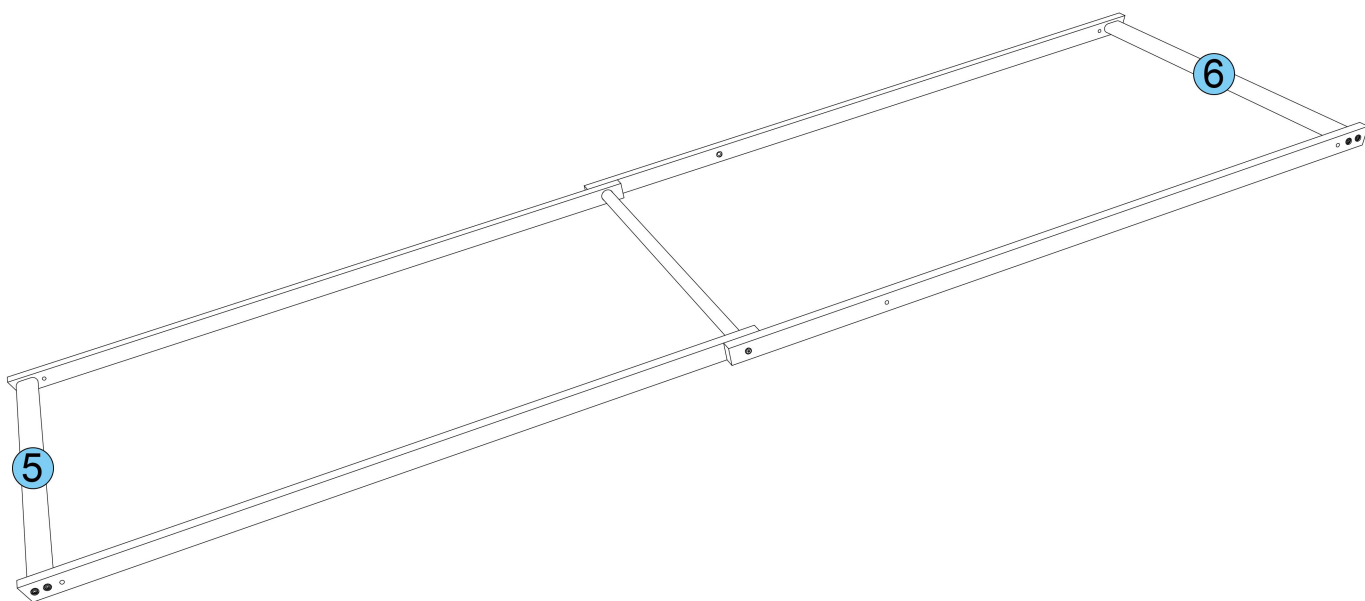

Tips: Roll frame over, make the holes of part 5 & 6 face downward

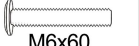

A		2
E		1

04-1

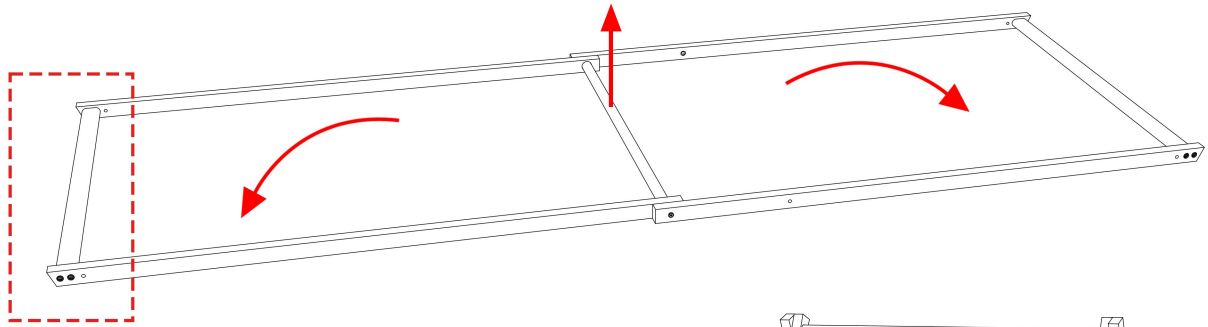

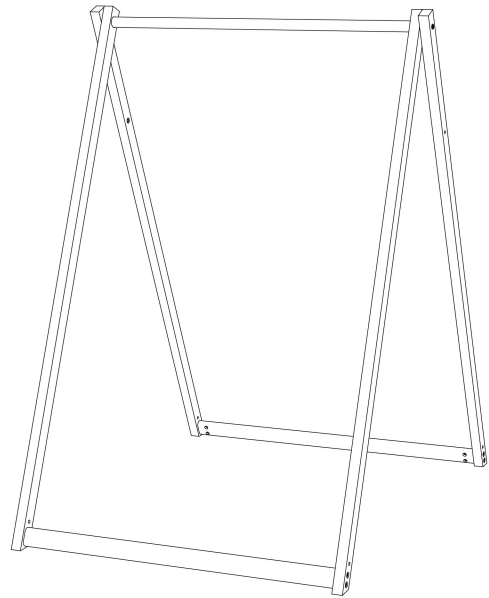

Make sure the angle of the bevel is consistent as shown, and stand it up to install the next steps

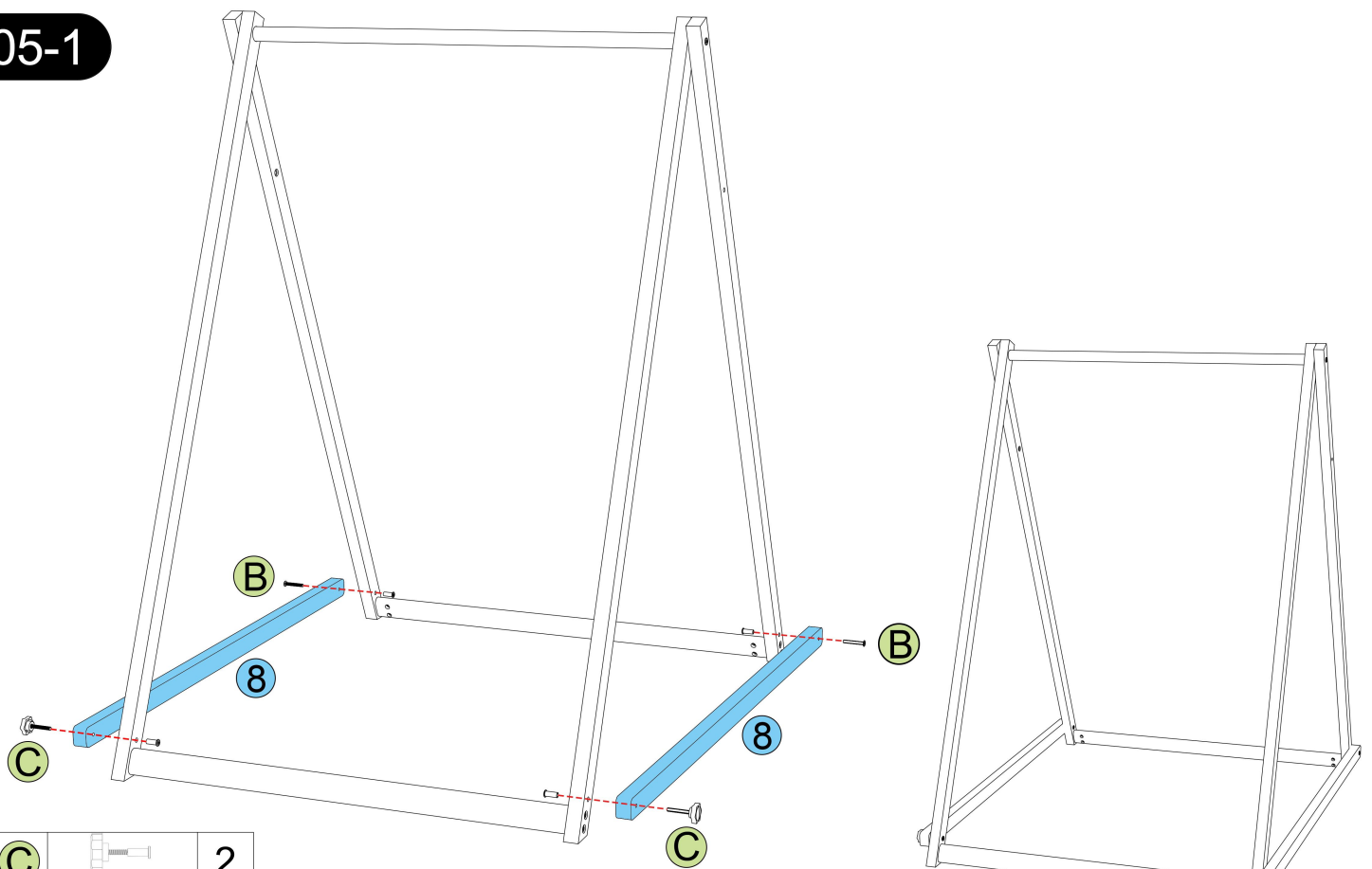

05-1

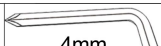

C	 M6x45 M6x20	2
B	 M6x45 M6x20	2

E	 4mm	2
----------	---	---

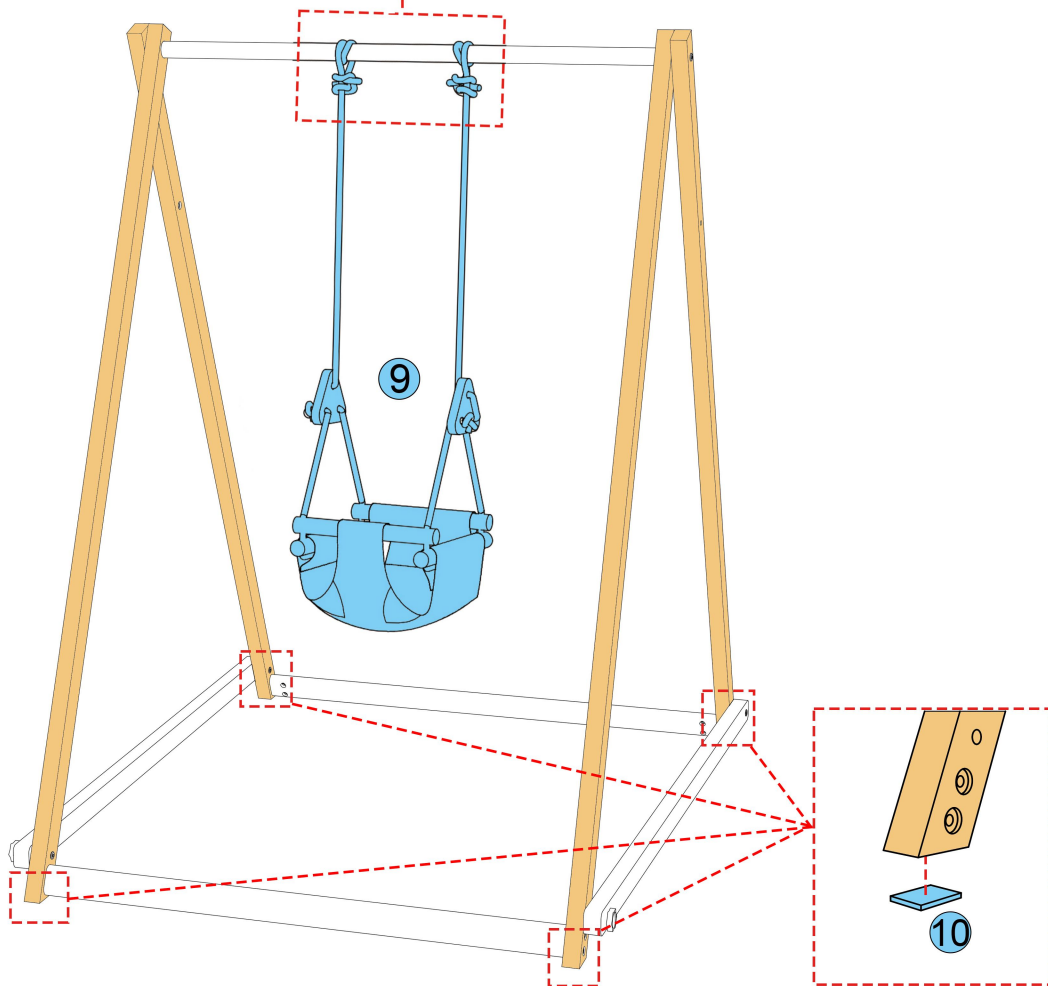
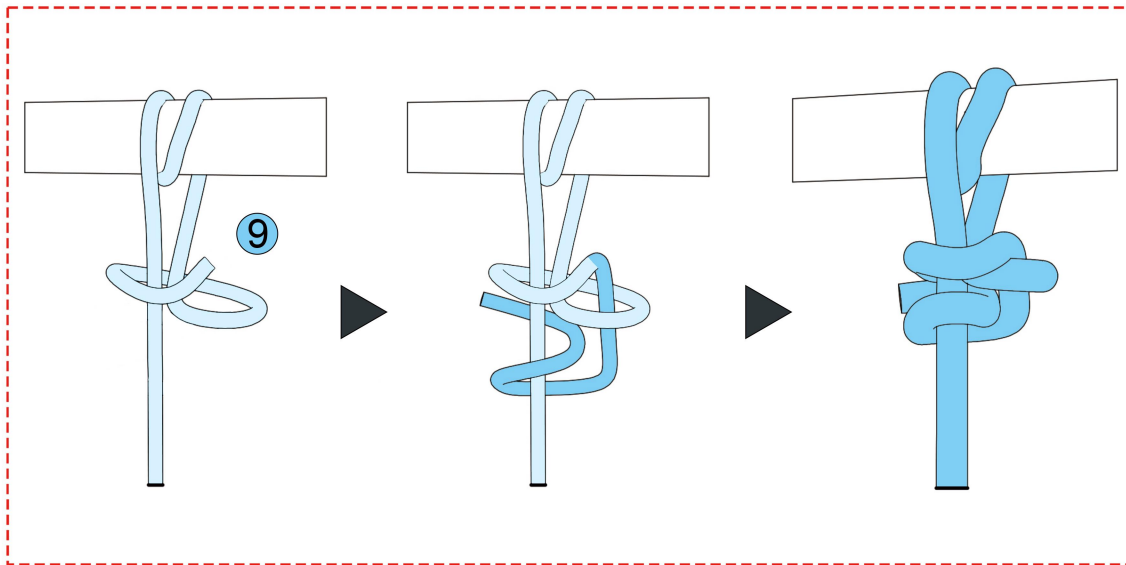

07-1

Note: Make sure the screws are tightened before each use. Do not use if screws are loose.

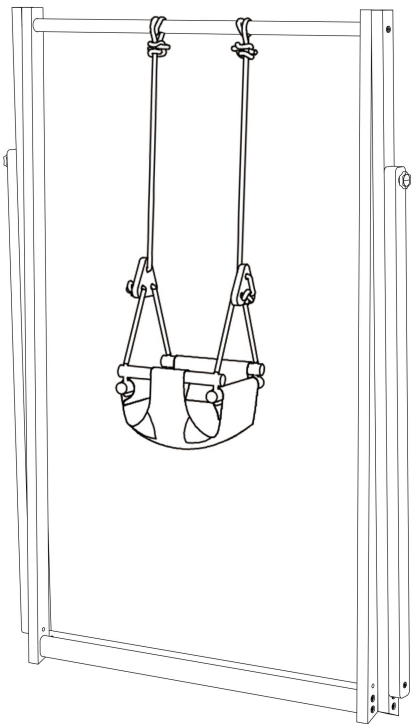
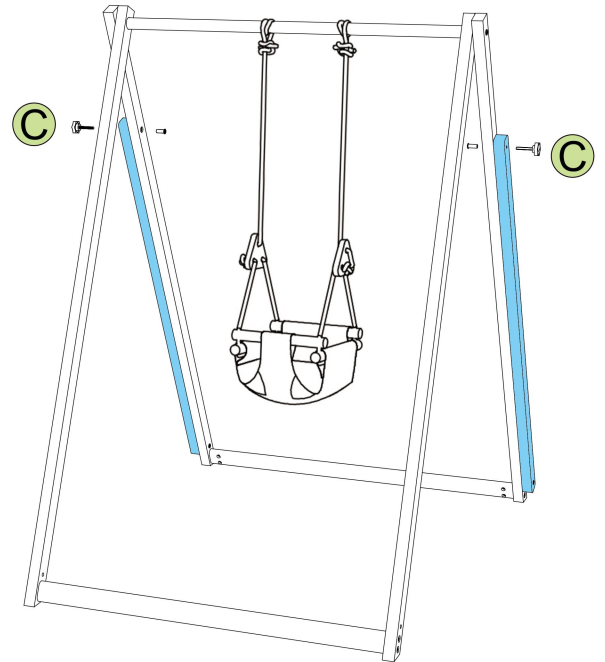
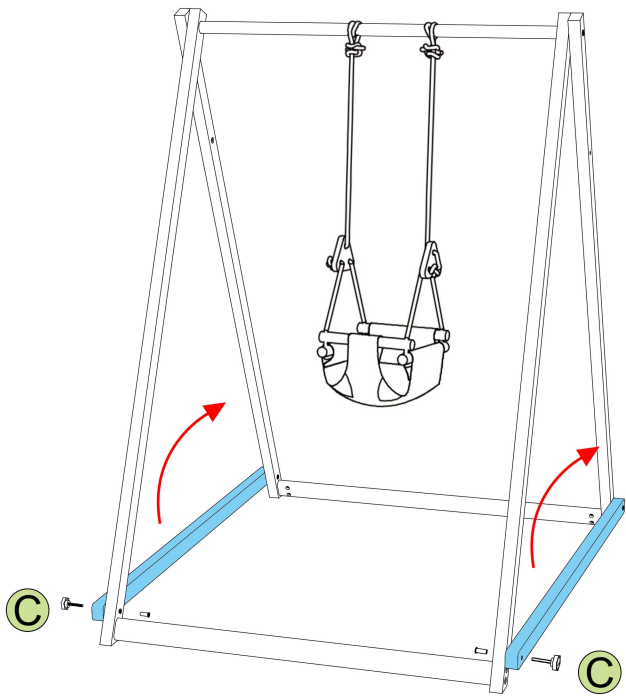

 C	 M6x45 M6x20	2
---	---	----------

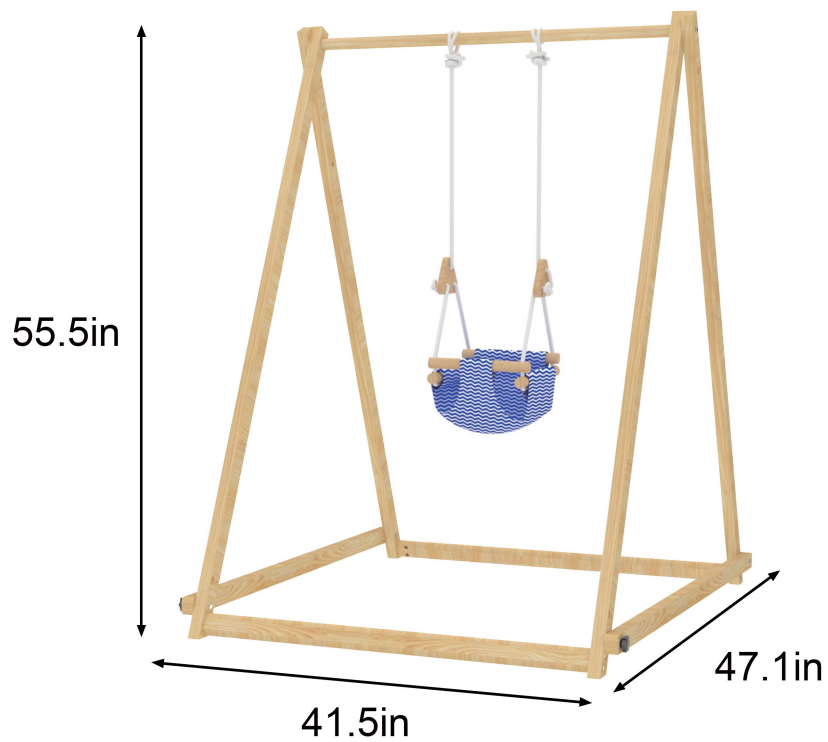

For questions with assembly or replacement parts, please email us at: info@avenlur.com or call us at: **888-697-3931**