

avenlur

Walnut by Avenlur

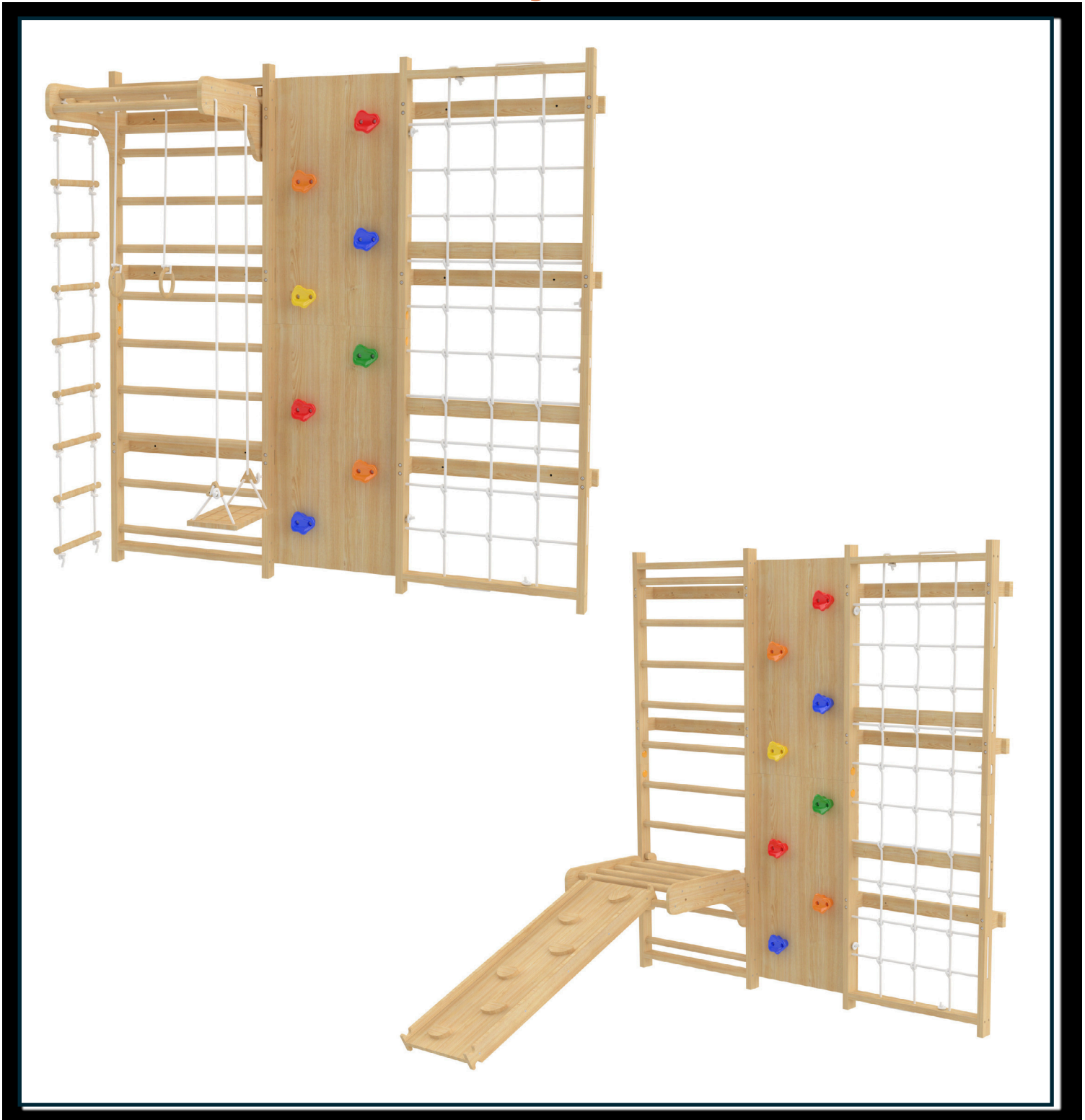

Need Help?

CALL US AT 888.697.3931 / M-F 9AM - 5PM PT (12PM - -8PM ET)
OR EMAIL US AT INFO@AVENLUR.COM

V2-79

OBSERVE ALL STATEMENTS AND WARNINGS TO REDUCE THE LIKELIHOOD OF SERIOUS OR FATAL INJURY.
SAVE THIS SHEET FOR FUTURE REFERENCE.

OPERATION INSTRUCTIONS

1. An adult should always supervise use of this product by children of all ages.
2. Maximum weight per user:
3. Instruct children not to attach items to the playground equipment that are not specifically designed for use with the equipment (examples: ropes, clothesline, pet leashes, cables and chain, etc) as they may cause a strangulation hazard or any other hazard.
4. Never allow children to use the equipment in a manner other than intended.

MAINTENANCE INSTRUCTIONS

1. Inspect the product periodically for loose or damaged components. **Tighten bolts if need.**
2. Check all connections and bolts for tightness at least twice monthly during the usage.
3. Check all coverings and bolts for sharp edges.

INSTALLATION INSTRUCTIONS

Please have an electrical drill available for assembly if possible.

If you have difficulty in installation, please contact us for help and get installation video for reference.

Please Ensure:

1. You are assembling with at least two people to ensure that all sides and parts are leveled.
2. You don't screw the parts in too hard or it will splinter the wood.
3. You follow the directions carefully.

CONTACT US BEFORE ASSEMBLY

If you have assembly questions or if you need parts
whether they are missing or damaged

Call us at 888-697-3931 or email us at

info@Avenlur.com

OBSERVAR TODAS LAS DECLARACIONES Y ADVERTENCIAS PARA REDUCIR LA PROBABILIDAD DE LESIONES GRAVES O MORTALES. GUARDE ESTA HOJA PARA FUTURAS REFERENCIAS.

INSTRUCCIONES DE USO

1. Un adulto siempre debe supervisar el uso de este producto por los niños de todas las edades.
2. Peso máximo por usuario:
3. Indique a los niños que no coloquen elementos en el equipo del patio de recreo que no estén específicamente diseñados para usarse con el equipo (ejemplos: cuerdas, tendedero, correas para mascotas, cables y cadenas, etc.) ya que pueden causar un peligro de estrangulación o cualquier otro peligro.
4. Nunca permita que los niños usen el equipo de una manera distinta a la prevista.

INSTRUCCIONES DE MANTENIMIENTO

1. Inspeccione el producto periódicamente para detectar componentes sueltos o dañados. Apriete los pernos si es neces.
2. Compruebe la estanqueidad de todas las conexiones y pernos al menos dos veces al mes durante el uso.
3. Compruebe todos los cubrimientos y los pernos para los bordes agudos.

INSTRUCCIONES DE INSTALACIÓN

Tenga un taladro eléctrico disponible para el montaje si es posible.

Si usted tiene dificultad en la instalación, por favor póngase en contacto con nosotros para obtener ayuda y obtener video de instalación para referencia.

Asegúrese de:

1. Usted está asmebling con al menos dos personas para asegurarse de que todos los lados y partes están nivelados.
2. Usted no atornillas las piezas en demasiado duro o se astillará la madera.
3. Siga las instrucciones cuidadosamente.

CONTACTENOS ANTES DE ENSAMBLAR

Si usted tiene preguntas de ensamblaje o necesita partes,
le faltan piezas o estan dañadas.

Lamenos al 888-697-3931 or escribanos a
info@avenlur.com

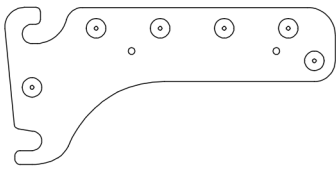

1 x1 23.3in

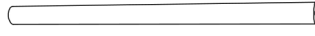

2 x6 24.4in



4 x4 25.4in



3 x10 26.5in



6 x2 25.4in



7 x1 39.4in



8 x1 39.4in

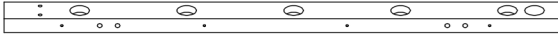

9 x1 39.4in



10 x1 39.4in

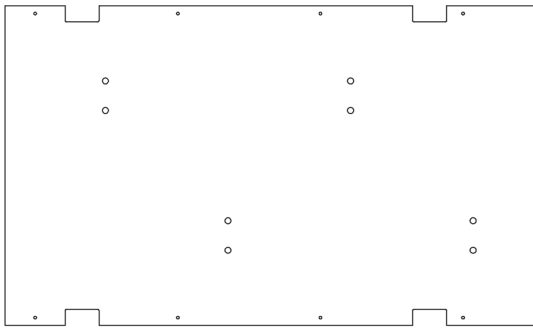

11 x1 37.4in

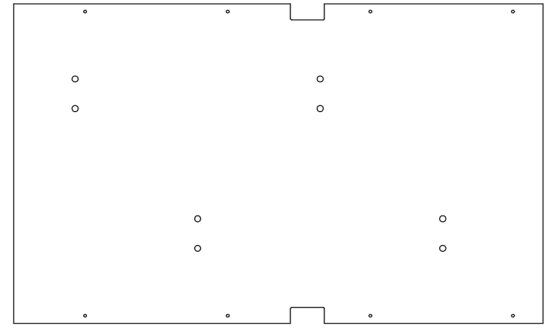

5 x1 37.4in



12 x1 39.4in



13 x1 39.4in

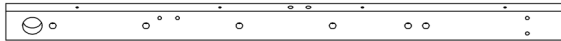

14 x1 39.4in



15 x1 39.4in

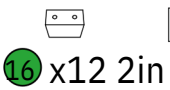

16 x12 2in

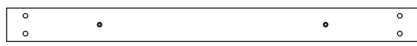

17 x6 29.1in



18 x2 45.3in

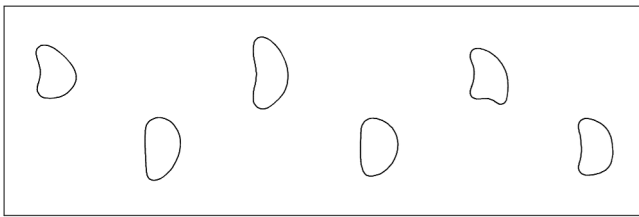

19 x1 45.2in

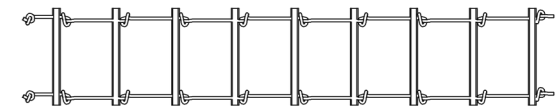

20 x1

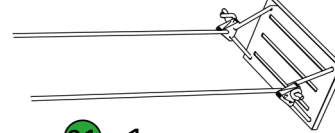

21 x1



22 x2



26 x2 51.2in



27 x2 189in



28 x1 322.8in



29 x8

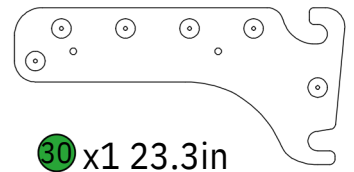

30 x1 23.3in



M6.3x40
A x66

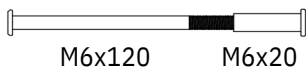

M6x120
B x24



M6x20
C x4

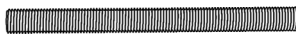

M8x100
D x8



M8
E x8



M8
F x8

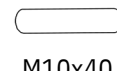

M10x40
G x8



M10
H x16



M4x40
I x16

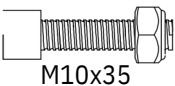

M10x35
J x12

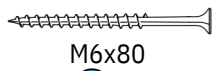

M6x80
K x2



M4
L x1

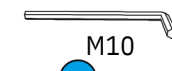

M10
M x1

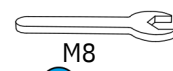

M8
N x1

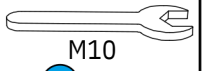

M10
O x1

Self-provided tools



Pen



Drill

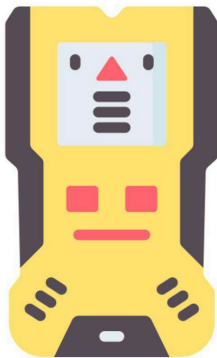

Studfinder



Measuring tape



Level

01-1

Note: Check all connections and bolts for tightness at least twice monthly during use. Do not use if screws are loose.

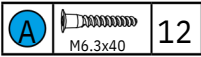
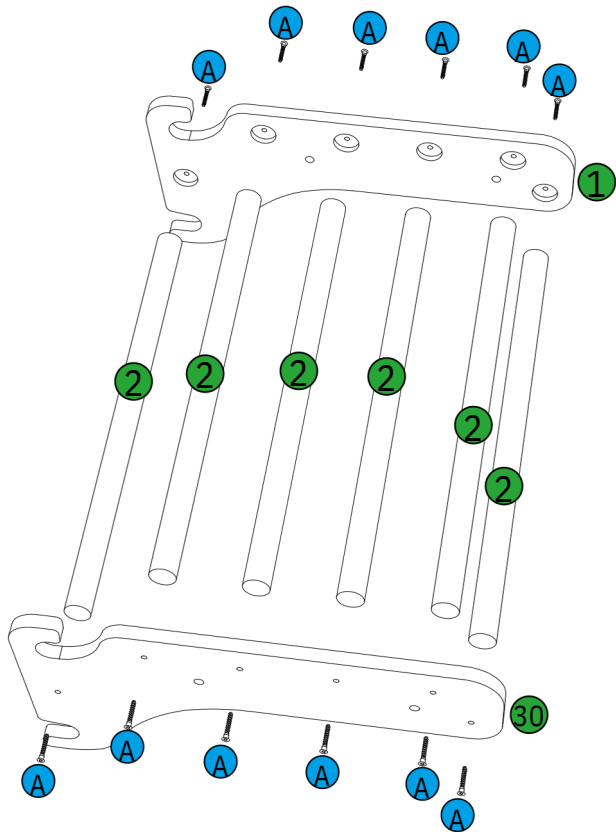

01-2

Note: Pay attention to all the black section markers. The manual may refer back to those later

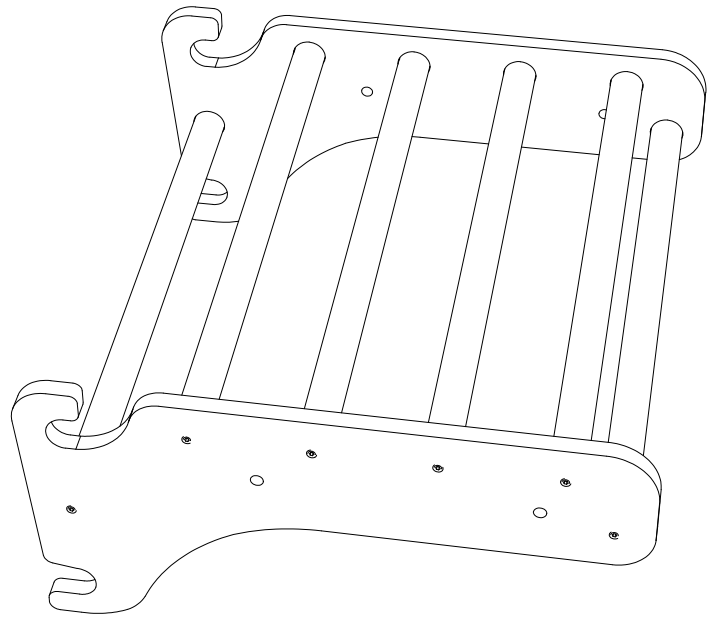

02-1

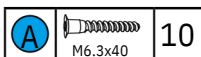
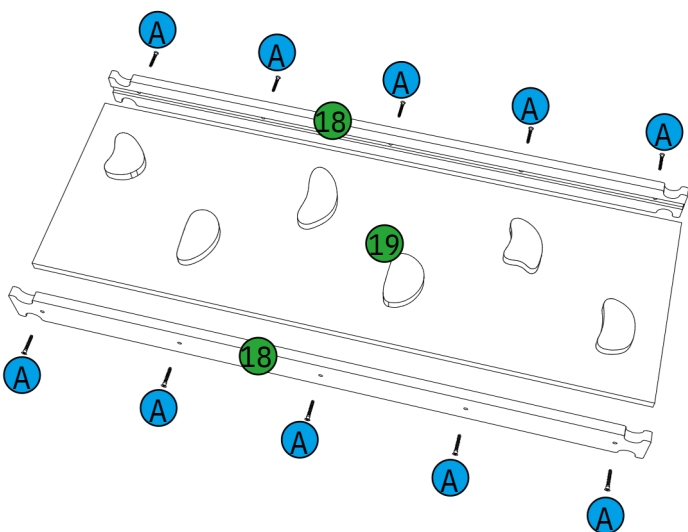

02-2

Note: Pay attention to all the black section markers. The manual may refer back to those later

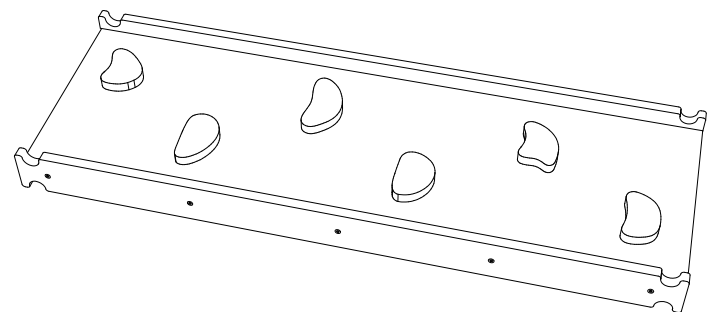

03-1

Note: Insert parts C and F into the holes. Then attach part D through C. Lastly, screw E onto C.

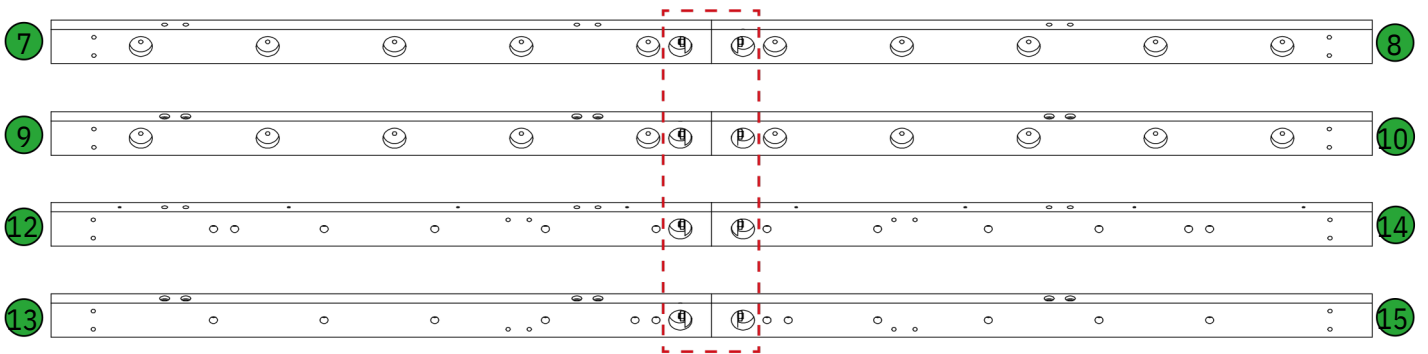
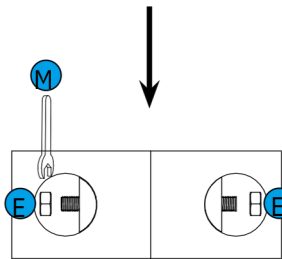
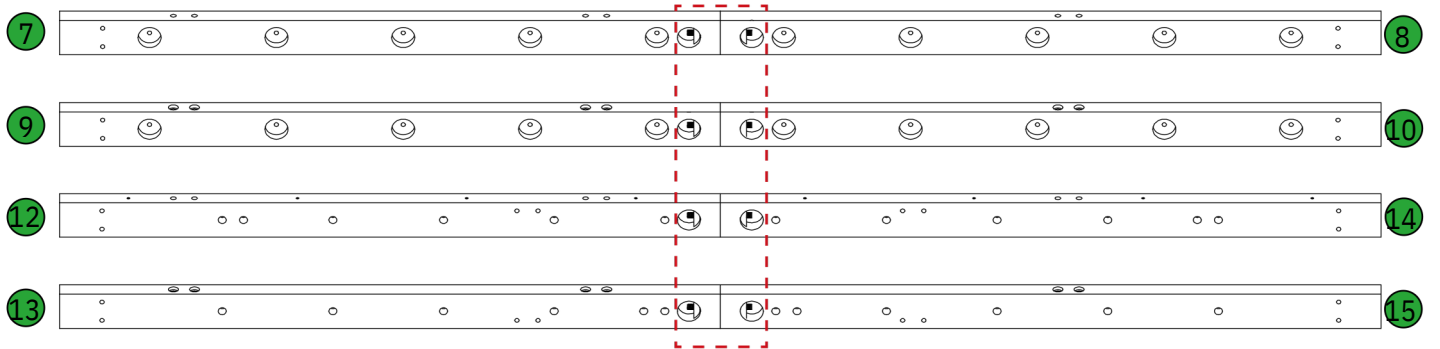
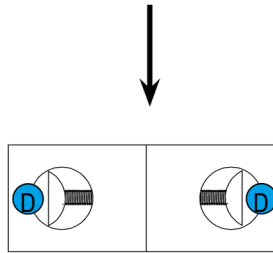
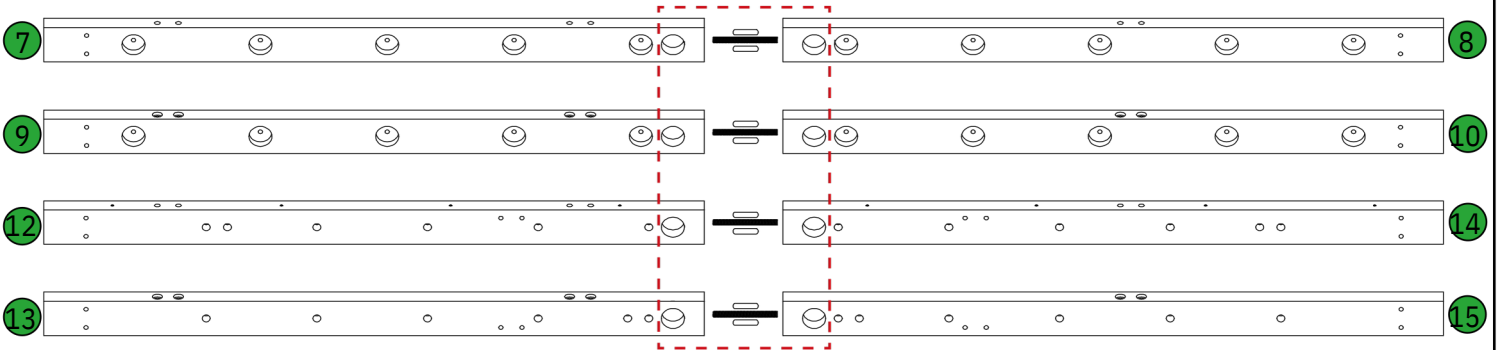
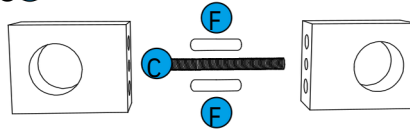

C		4	E		8	M		1
D		8	F		8			
	M8x100			M8			M8	
				M10x40				

04-1

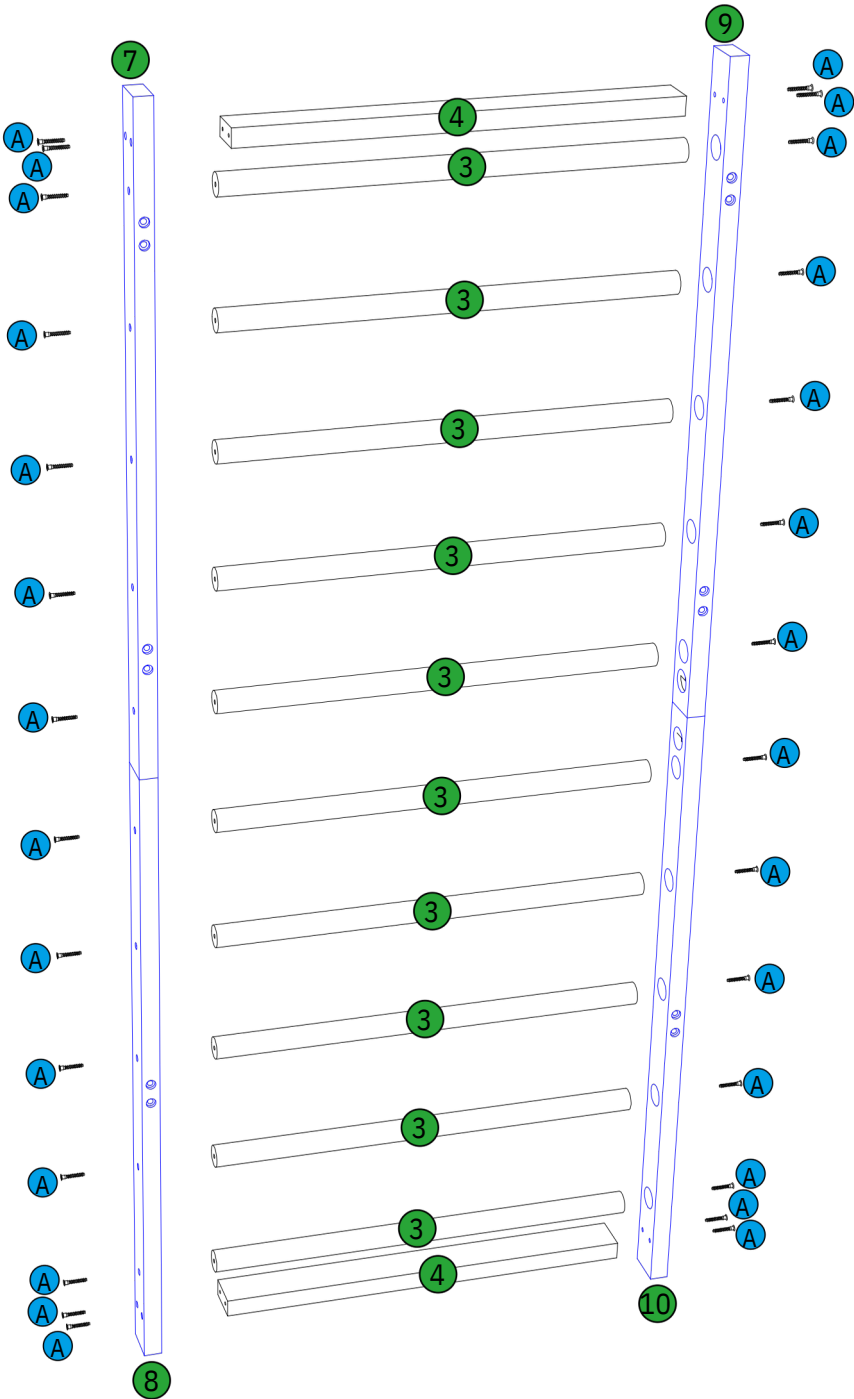

04-2

Note: Pay attention to all the black section markers. The manual may refer back to those later

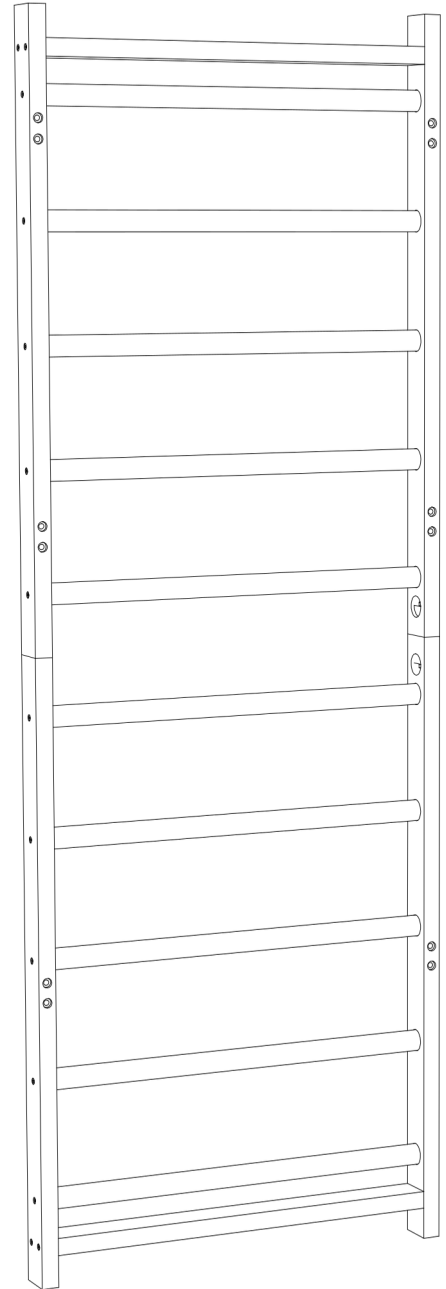

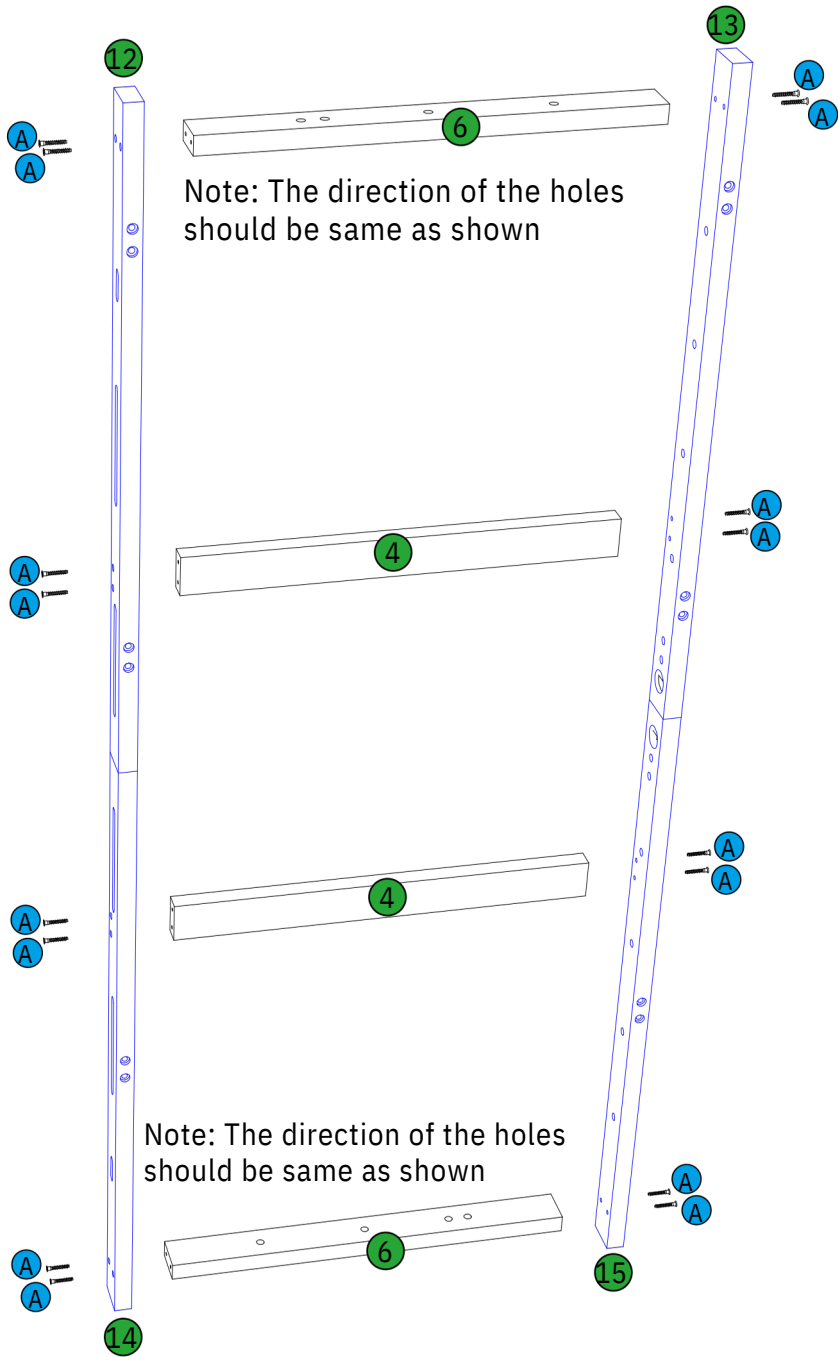

05-1

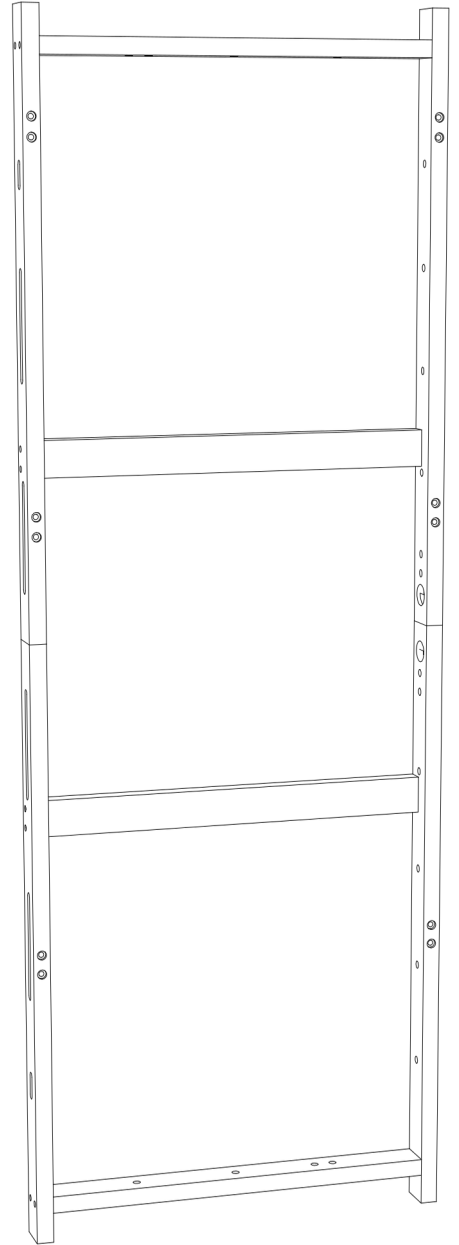

05-2



		16
M6.3x40		

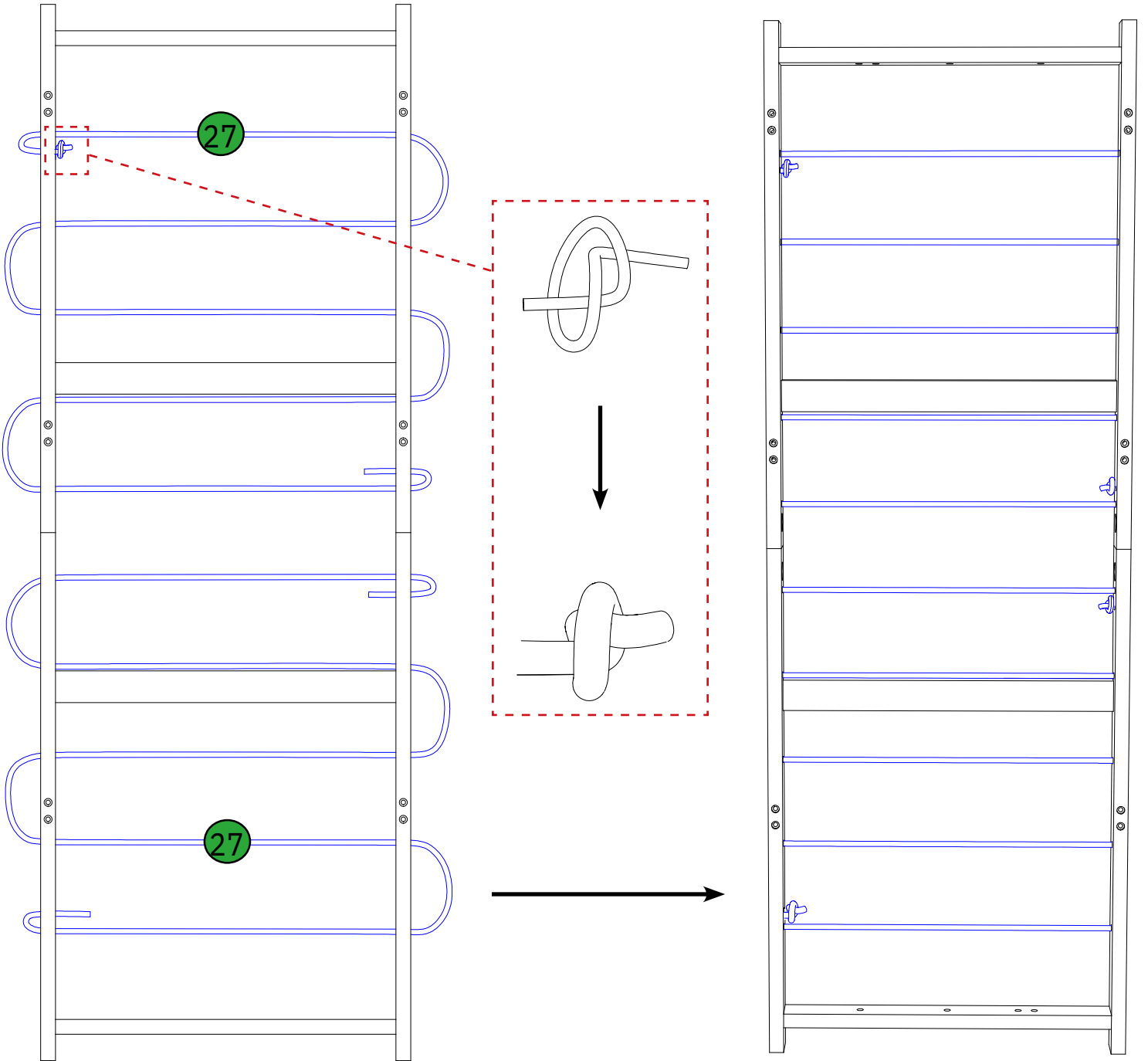

07-1

Note: Pay attention to all the black section markers. The manual may refer back to those later.

Wrap the vertical rope once around each pass of the horizontal rope

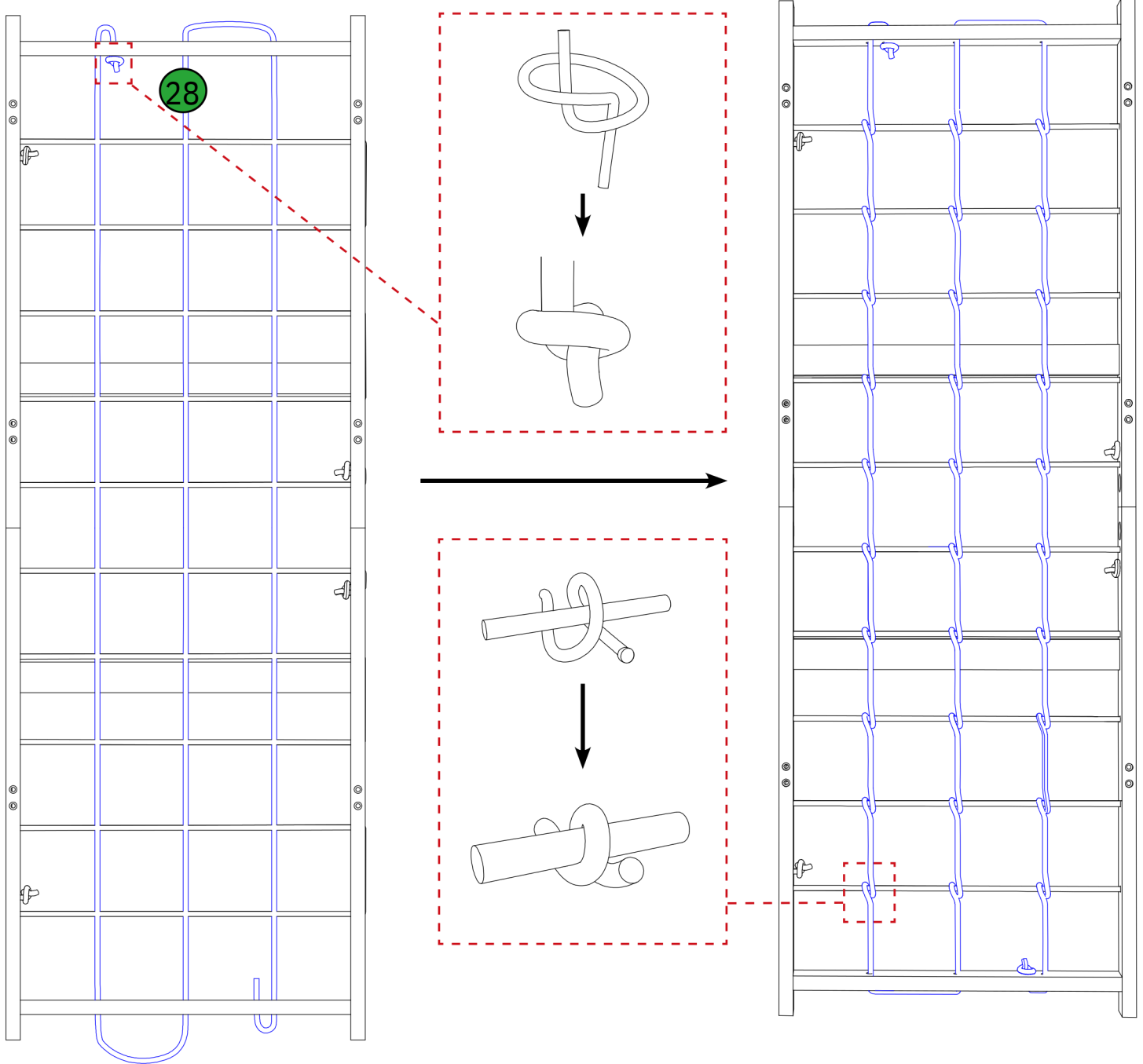

08-1

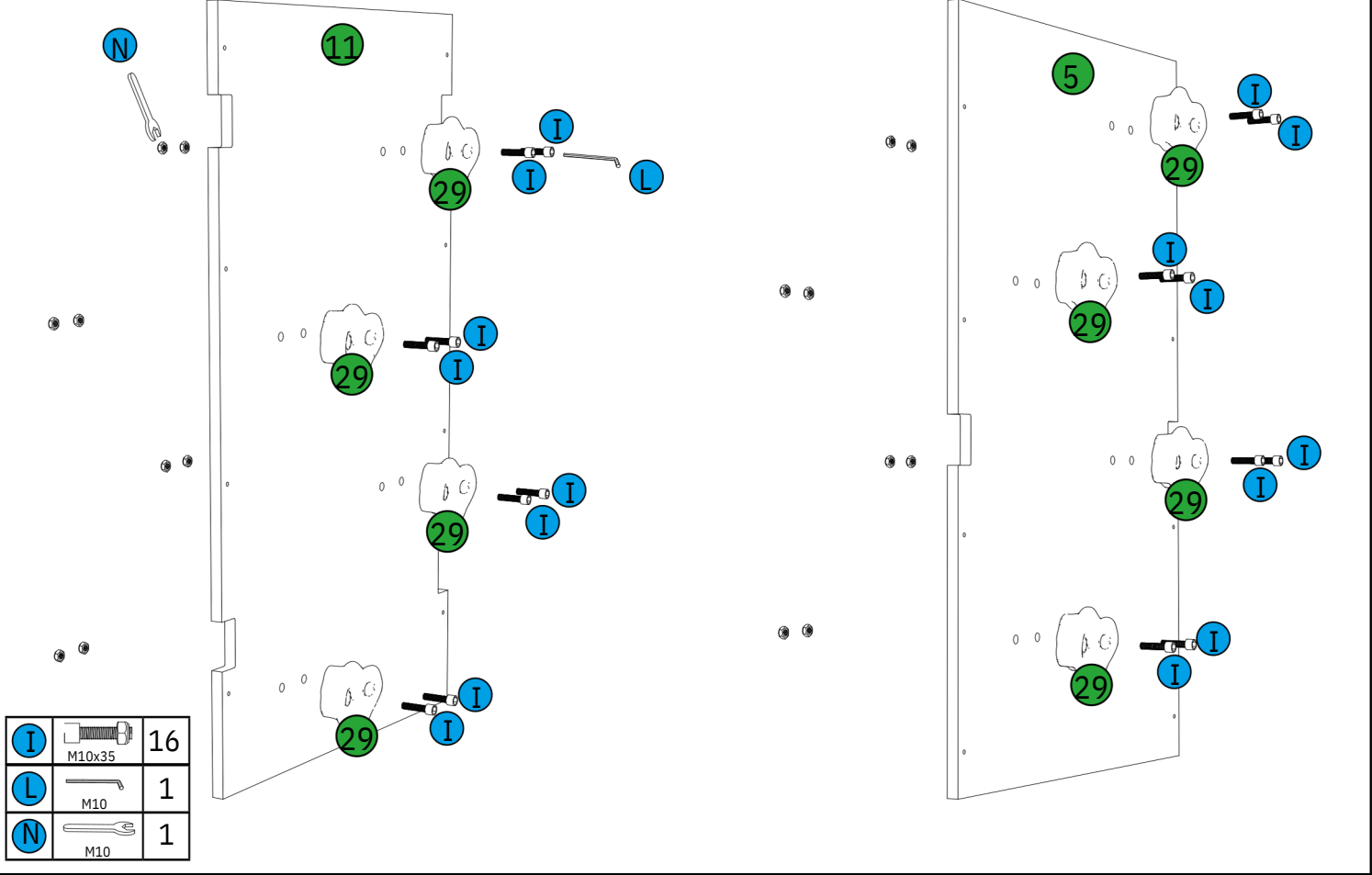

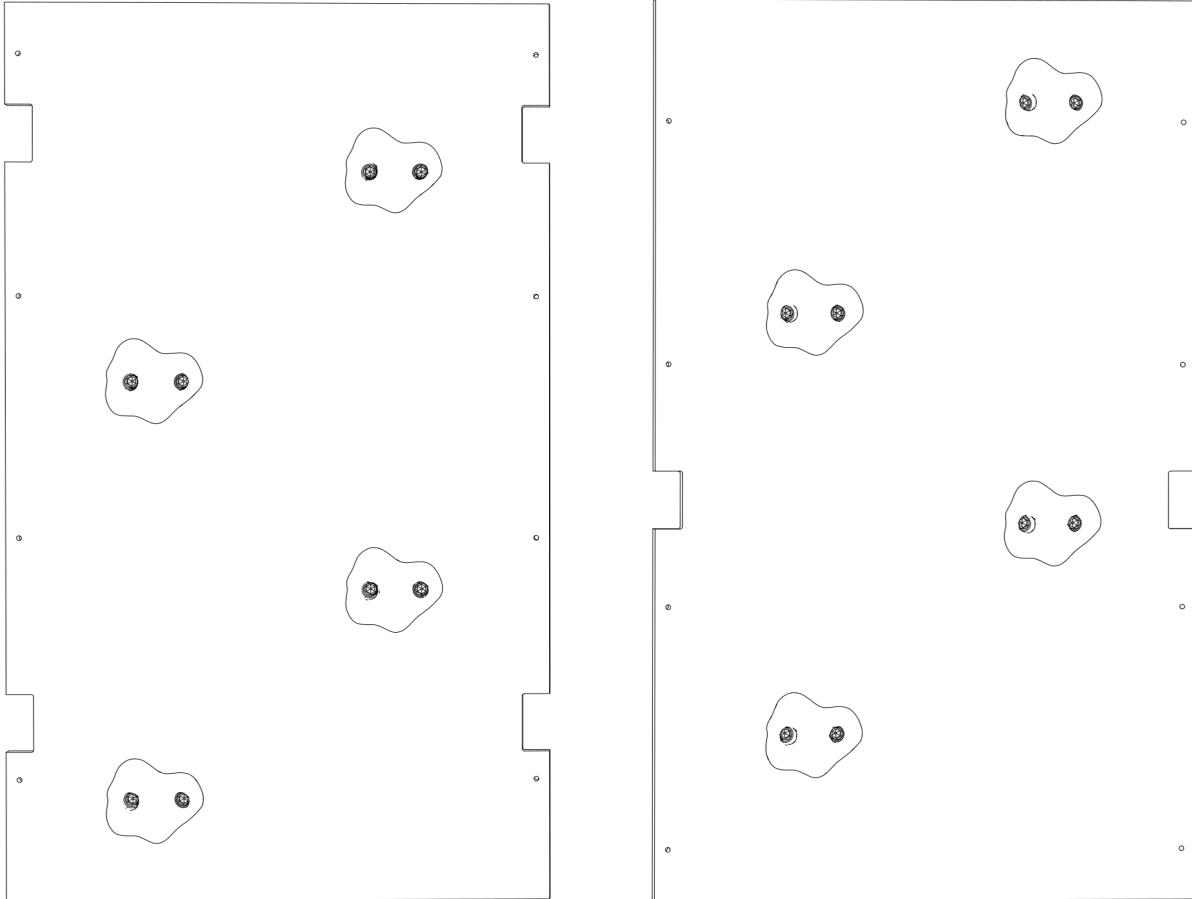

08-2

Note: Pay attention to all the black section markers. The manual may refer back to those later

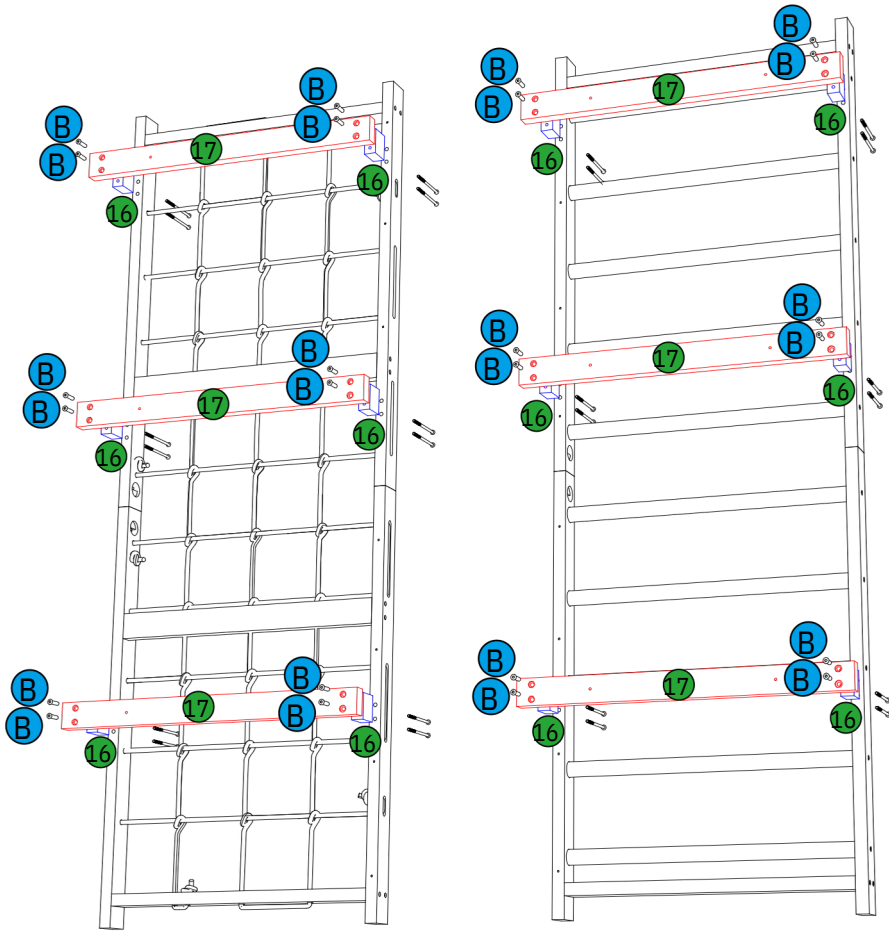

09-1



B  24
M6x120 M6x20

09-2

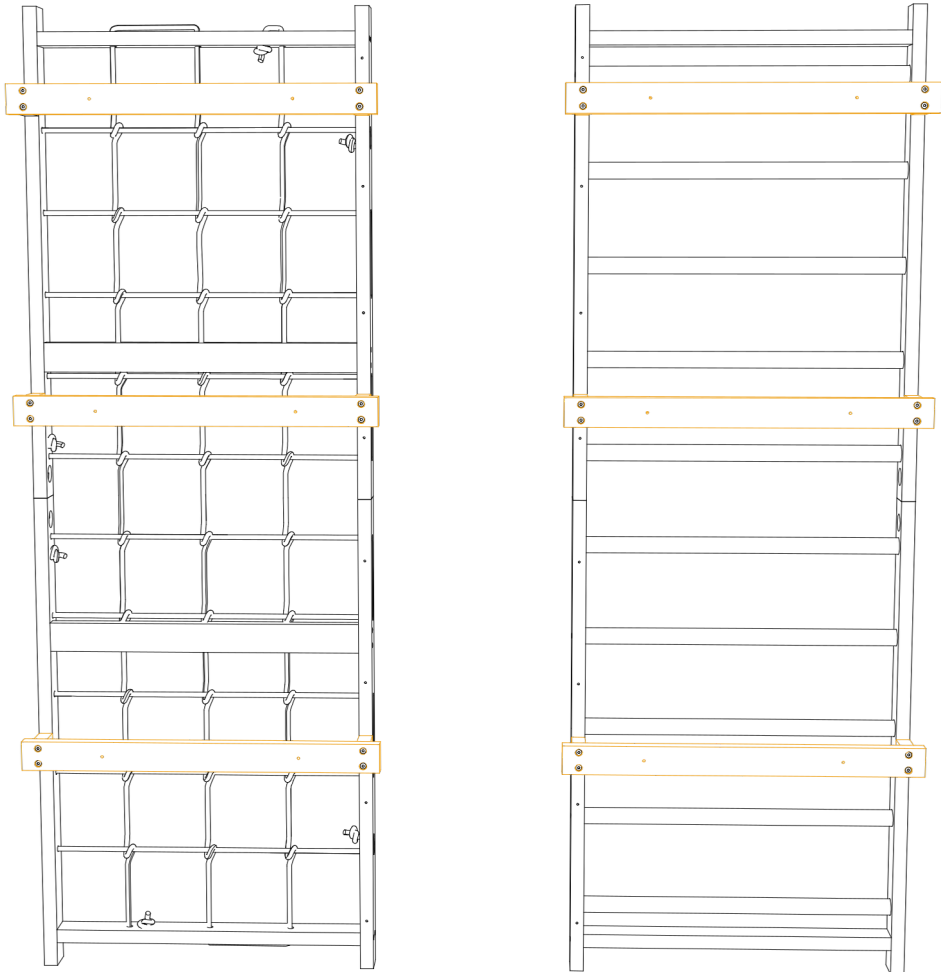

10-1

Front side

09-2

08-2

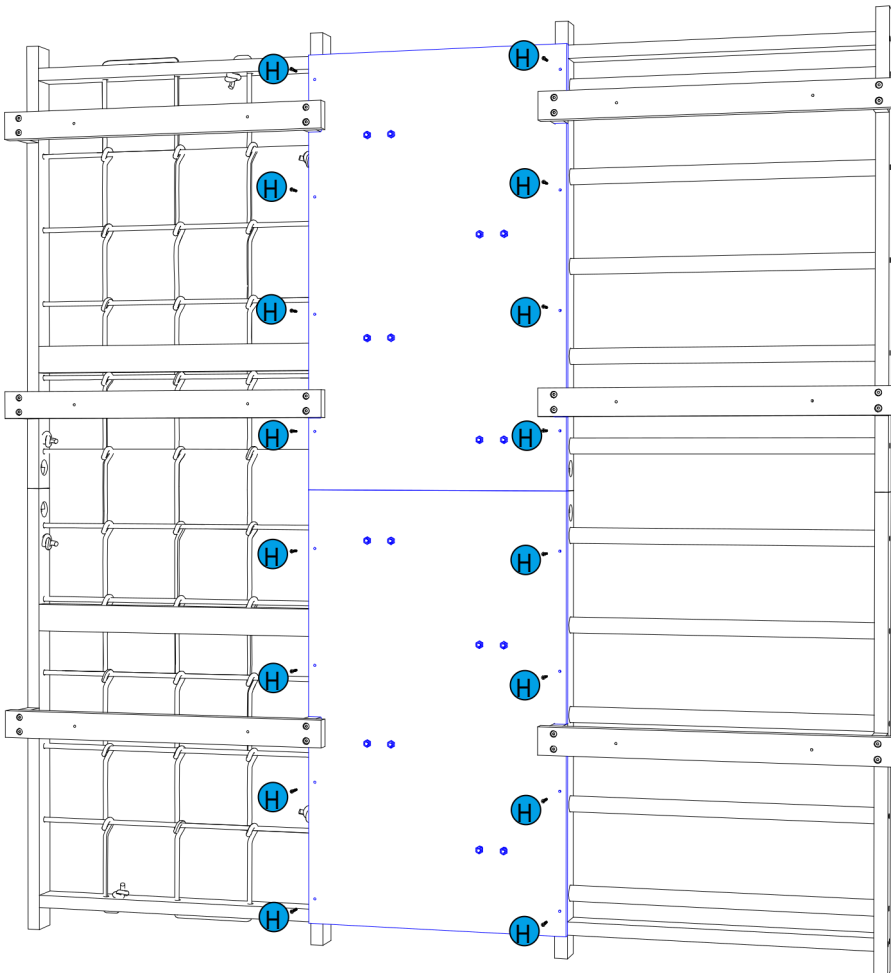

09-2

08-2

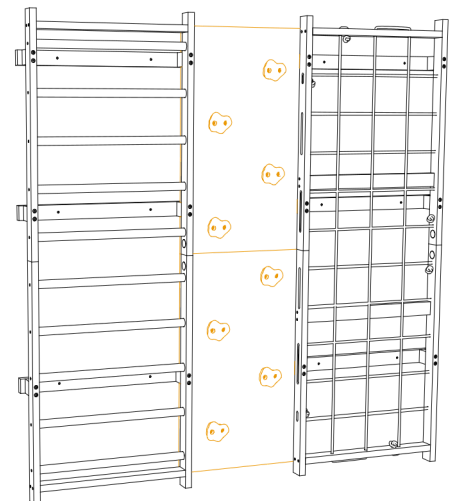

Back side



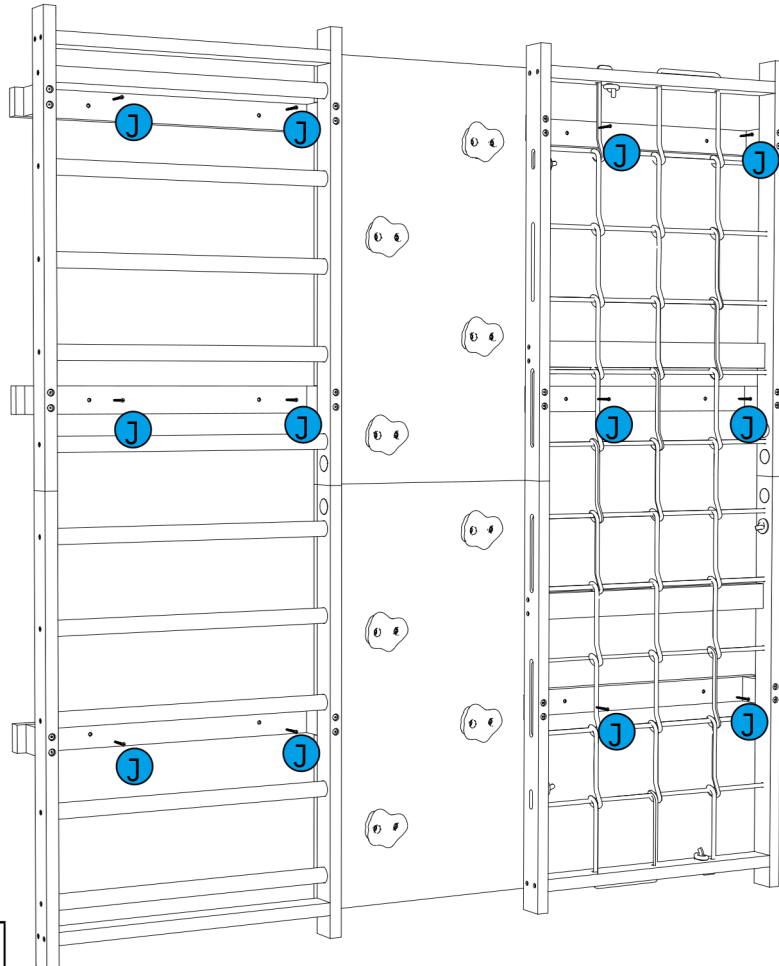

	 M4x40	16
------------------------------------------------------------------------------------	----------------------------------------------------------------------------------------------	----

11-1



Note: Use a studfinder and mark the wall where the center of the studs are. Studs are typically 16" apart. Measure the distance between your studs to confirm, Mark, level, and predrill holes in the wall to attach parts 17 with screws J

		12
M6x80		

11-2

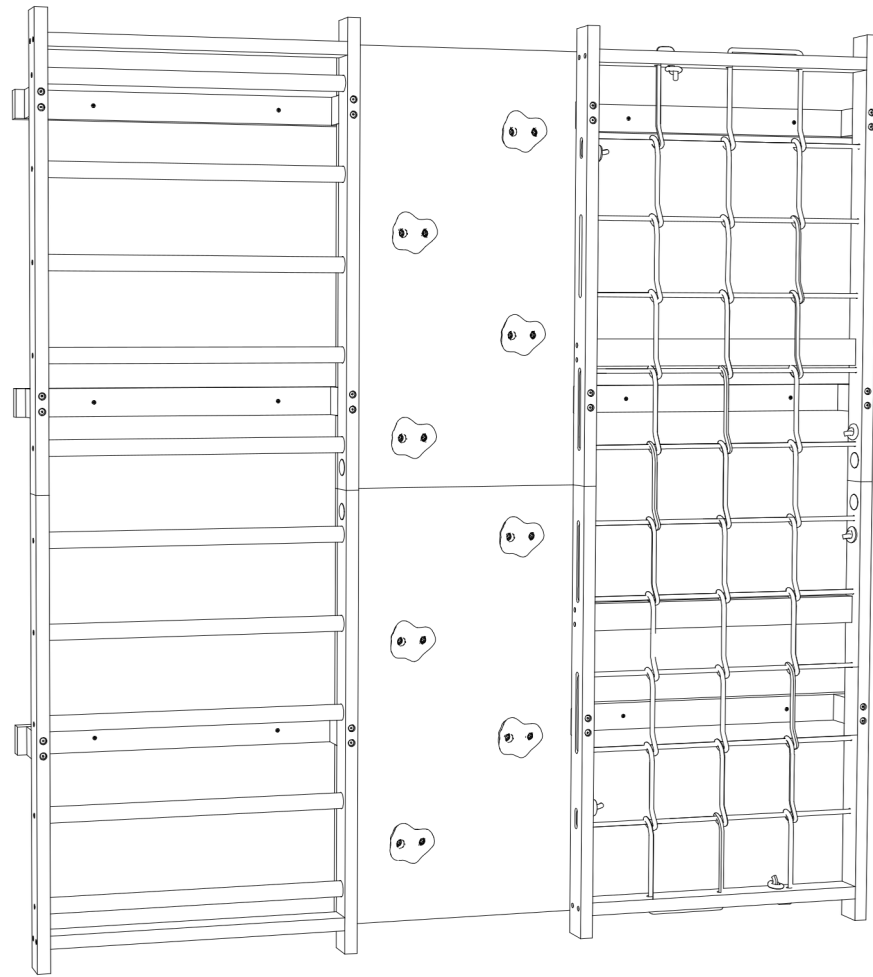

12-1

01-2

